

SANMOTION

5-PHASE STEPPING SYSTEMS

F5



Ver.5

SANYO DENKI

SANMOTION

5-PHASE STEPPING SYSTEMS

F5



AC input Set model Micro step



DC input Set model Micro step, full step / half step



AC input Driver



DC input Driver



Stepping Motor

28mm sq. to 60mm sq. , ϕ 60mm to ϕ 106mm



Linear Actuator Stepping Motor,
Stepping Motor for vacuum environment

Index

Features	P. 4
Line Up	P. 5
Lineup Details	P. 6
AC input Set model	P. 8
Micro step	P. 8
System Configuration	P. 8
Model number convention	P. 9
Set Model Configuration	P. 10
Optional Accessories	P. 11
Specifications Standard model	P. 12
Specifications CE / UL model	P. 15
Specifications Low-backlash gear model	P. 18
Specifications Harmonic gear model	P. 23
Specifications Electromagnetic brake model	P. 25
Motor specifications	P. 28
Driver specifications	P. 29
Driver Controls and Connectors	P. 30
Connections and Signals	P. 31
DC input Set model	P. 34
Micro step	P. 34
System Configuration	P. 34
Model number convention	P. 35
Set Model Configuration	P. 36
Optional Accessories	P. 37
Specifications Standard model	P. 38
Specifications Low-backlash gear model	P. 41
Specifications Spur gear model	P. 46
Specifications Harmonic gear model	P. 48
Specifications Electromagnetic brake model	P. 51
Motor specifications	P. 53
Driver specifications	P. 54
Driver Controls and Connectors	P. 55
Connections and Signals	P. 56
DC input Set model	P. 60
Full/half step	P. 60
System Configuration	P. 60
Model number convention	P. 61
Set Model Configuration	P. 62
Specifications Standard model	P. 63
Specifications Low-backlash gear model	P. 66
Specifications Spur gear model	P. 71
Specifications Harmonic gear model	P. 73
Specifications Electromagnetic brake model	P. 76
Motor specifications	P. 78
Driver specifications	P. 79
Driver Controls and Connectors	P. 80
Connections and Signals	P. 81
Stepping Motor	P. 84
Linear Actuator Stepping Motor	P. 95
Stepping Motor for vacuum environment	P. 96
Dimensions	P. 97
Safety Consideration	P. 107



SANMOTION

5-PHASE STEPPING SYSTEMS

F5

SANMOTION F5 is a five-phase stepping system that provides precise positioning with simple control. The typical basic step angle is 0.72° , precisely controlled by pulse signals.

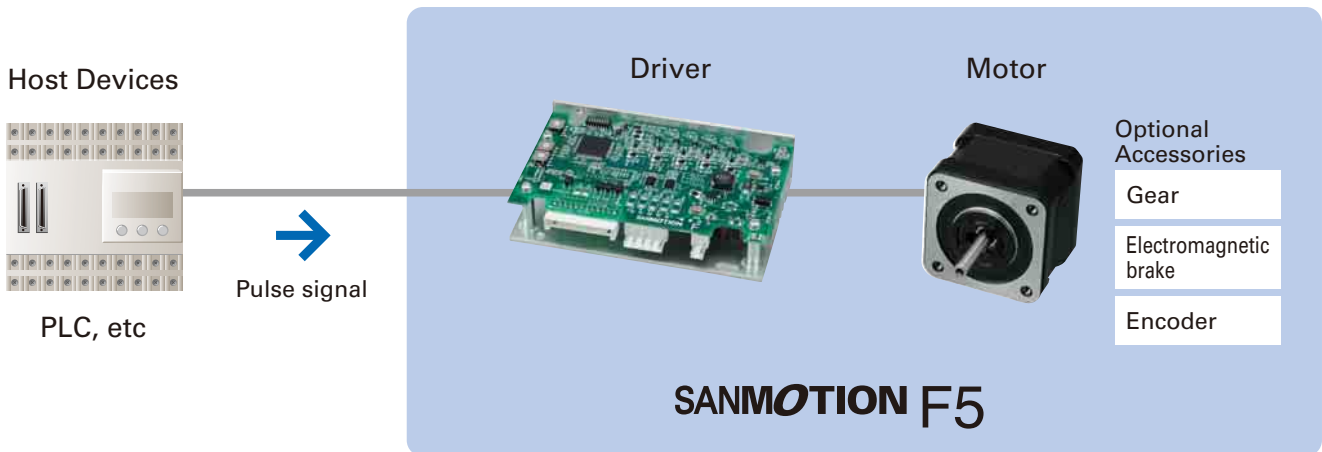

Features

- Small driver and motor, yet high torque.
- Fast response provides shorter system cycle time for repetitive operations.
- Holding torque maintains the stop position when turning on power. Electromagnetic brake models maintain position even with power off.
- Automicro function For DC input, only specific model (micro-step)
Smooth drive is provided even with coarse resolution of one division (full-step) or two (half-step) settings. Vibration suppression is executed internally and independently from the controller.
- Microstepping system For DC input, only specific model (micro-step)
Multiples of the 0.72° basic step angle resolution can be set in 16 steps from 1 to 250 divisions. (0.72° to 0.00288° / pulse)
Provides smooth drive with low vibration.

Safety standards

All SANMOTION F5 drivers are specified according to standards, and comply with UL and CE (EN standards).
You can select driver/motor sets that comply UL and CE standards.



Line up

Motor/driver sets are conveniently available in either AC or DC models.

DC models include micro-step and full-/half-step drivers.

Beside the set models, stepping motors can be purchased independently.

The product line includes linear actuator stepping motors with straight line drives, and vacuum-compatible stepping motors.

Set model

AC input (Micro step)

Standard model

This is the basic model AC driver/motor set.

Motor size

42mm sq. (1.65inch sq.)/60mm sq. (2.36inch sq.)/
 ø86mm (ø 3.39inch)/ø 106mm (ø 4.17inch)



CE / UL model

This model motor/driver set complies with CE and UL standards.

Motor size

42mm sq. (1.65inch sq.)/60mm sq. (2.36inch sq.)/
 ø86mm (ø 3.39inch)/ø 106mm (ø 4.17inch)



Low-backlash gear model

This set employs low backlash conically hobbled gears to engage the output stage of the speed reduction mechanism.

Motor size 42mm sq. (1.65inch sq.)/60mm sq. (2.36inch sq.)/
 ø86mm (ø 3.39inch)

Reduction gear ratios 1:3.6 / 1:7.2 / 1:10 / 1:20 / 1:30 / 1:36



Harmonic gear model

This model employs harmonic gears for up to 1:100 resolution.

Motor size 42mm sq. (1.65inch sq.)/60mm sq. (2.36inch sq.)/
 ø86mm (ø 3.39inch)

Reduction gear ratios 1:30 / 1:50 / 1:100



Electromagnetic brake model

This set utilizes a non-excitation electromagnetic brake to maintain position in vertical load applications and hold load even during power off.

Motor size 42mm sq. (1.65inch sq.)/60mm sq. (2.36inch sq.)/
 ø86mm (ø 3.39inch)



DC input (42mm sq. (1.65inch sq.)/60mm sq. (2.36inch sq.))

Standard model

This is the basic model DC driver/motor set.

Motor size

28mm sq. (1.10inch sq.)/42mm sq. (1.65inch sq.)/
 60mm sq. (2.36inch sq.)/ø86mm (ø 3.39inch)

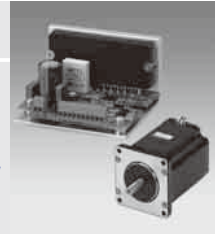

Low-backlash gear model

This set employs low backlash conically hobbled gears to engage the output stage of the speed reduction mechanism.

Motor size 42mm sq. (1.65inch sq.)/60mm sq. (2.36inch sq.)/
 ø86mm (ø 3.39inch)

Reduction gear ratios 1:3.6 / 1:7.2 / 1:10 / 1:20 / 1:30 / 1:36

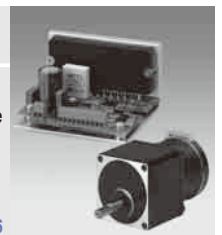

Spur gear model

This set employs a spur gear in the speed reduction mechanism.

Motor size 28mm sq. (1.10inch sq.)

Reduction gear ratios 1:3.6 / 1:7.2 / 1:10 / 1:20 / 1:30 / 1:50

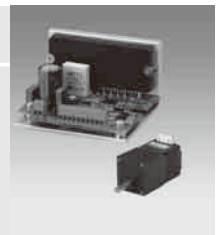

Harmonic gear model

This model employs harmonic gears for up to 1:100 resolution.

Motor size 28mm sq. (1.10inch sq.)/42mm sq. (1.65inch sq.)/
 60mm sq. (2.36inch sq.)/ø86mm (ø 3.39inch)

Reduction gear ratios 1:30 / 1:50 / 1:100

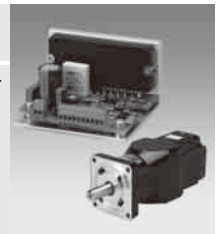

Electromagnetic brake model

This set utilizes a non-excitation electromagnetic brake to maintain position in vertical load applications and hold load even during power off.

Motor size 42mm sq. (1.65inch sq.)/60mm sq. (2.36inch sq.)/
 ø86mm (ø 3.39inch)

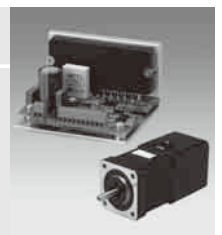

Stepping Motor

When ordering a motor only, select from a variety of motor sizes.

Separate driver is required.

Motor size

28mm sq. (1.10inch sq.)/
 39mm sq. (1.54inch sq.)/
 42mm sq. (1.65inch sq.)/
 50mm sq. (1.97inch sq.)/
 60mm sq. (2.36inch sq.)/
 ø60mm (ø 2.36inch)/
 ø86mm (ø 3.39inch)/ø 106mm (ø 4.17inch)



Linear Actuator Stepping Motor

This motor employs an integrated ball screw for linear motion.

Separate driver is required.

Motor size

42mm sq. (1.65inch sq.)/
 60mm sq. (2.36inch sq.)



Stepping motor for vacuum environment

This motor is customized for use in systems operating in vacuum environments.

Separate driver is required.

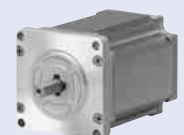

Lineup Details

Set model P8 -

Series		AC input Set model Micro step	DC input Set model Micro step	DC input Set model Full / half step
Power supply		Single phase AC100V to 230V	DC24V/48V	DC24V/36V
Number of divisions		1 to 250	5-phase mode : 1 to 250 2-phase mode : 0.4 to 102.4	1 (Full step), 2 (Half step)
Basic step angle		0.72° to 0.00288° /pulse	5-phase mode : 0.72° to 0.00288° /pulse 2-phase mode : 1.8° to 0.00703125° /pulse	0.72° to 0.36° /pulse
Stepping motor connection method*		pentagon connection	New pentagon connection	New pentagon connection
Model types and corresponding motor sizes (reduction ratios in parentheses)	Standard	42mm sq. (1.65inch sq.)/60mm sq. (2.36inch sq.)/ ϕ 86mm (ϕ 3.39inch)/ ϕ 106mm (ϕ 4.17inch)	28mm sq. (1.10inch sq.)/42mm sq. (1.65inch sq.)/60mm sq. (2.36inch sq.)/ ϕ 86mm (ϕ 3.39inch)	28mm sq. (1.10inch sq.)/42mm sq. (1.65inch sq.)/60mm sq. (2.36inch sq.)/ ϕ 86mm (ϕ 3.39inch)
	CE · UL	42mm sq. (1.65inch sq.)/60mm sq. (2.36inch sq.)/ ϕ 86mm (ϕ 3.39inch)/ ϕ 106mm (ϕ 4.17inch)	—	—
	Low-backlash gear model	42mm sq.(1.65inch sq.)/60mm sq. (2.36inch sq.)/ ϕ 86mm (ϕ 3.39inch) (1:3.6 / 1:7.2 / 1:10 / 1:20 / 1:30 / 1:36)	42mm sq. (1.65inch sq.)/60mm sq. (2.36inch sq.)/ ϕ 86mm (ϕ 3.39inch) (1:3.6 / 1:7.2 / 1:10 / 1:20 / 1:30 / 1:36)	42mm sq. (1.65inch sq.)/60mm sq. (2.36inch sq.)/ ϕ 86mm (ϕ 3.39inch) (1:3.6 / 1:7.2 / 1:10 / 1:20 / 1:30 / 1:36)
	Spur gear model	—	28mm sq. (1.10inch sq.) (1:3.6 / 1:7.2 / 1:10 / 1:20 / 1:30 / 1:50)	28mm sq. (1.10inch sq.) (1:3.6 / 1:7.2 / 1:10 / 1:20 / 1:30 / 1:50)
	Harmonic gear model	42mm sq. (1.65inch sq.)/60mm sq. (2.36inch sq.)/ ϕ 86mm (ϕ 3.39inch) (1:30 / 1:50 / 1:100)	28mm sq. (1.10inch sq.)/42mm sq. (1.65inch sq.)/60mm sq. (2.36inch sq.)/ ϕ 86mm (ϕ 3.39inch) (1:30 / 1:50 / 1:100)	28mm sq. (1.10inch sq.)/42mm sq. (1.65inch sq.)/60mm sq. (2.36inch sq.)/ ϕ 86mm (ϕ 3.39inch) (1:30 / 1:50 / 1:100)
	Electromagnetic brake model	42mm sq. (1.65inch sq.)/60mm sq. (2.36inch sq.)/ ϕ 86mm (ϕ 3.39inch)	42mm sq. (1.65inch sq.)/60mm sq. (2.36inch sq.)/ ϕ 86mm (ϕ 3.39inch)	42mm sq. (1.65inch sq.)/60mm sq. (2.36inch sq.)/ ϕ 86mm (ϕ 3.39inch)
Control method		Pulse input · Open loop	Pulse input · Open loop	Pulse input · Open loop
Set model configuration items		Driver · Motor · Connector	Driver · Motor · DC power cable (1m) Motor cable (1m) I/O signal cable (1m)	Driver · Motor
Optional Accessories		AC power cable (1 to 10m) Motor cable (1 to 10m) I/O signal cable (1 to 2m)	Regeneration resistor	—
Page	System Configuration	P.8	P.34	P.60
	Set Model Configuration	P.10	P.36	P.62
	Specifications and Characteristics	P.12 to 27	P.38 to 52	P.63 to 77
	Motor specifications · Driver specifications · Safety standards	P.28 to 29	P.53 to 54	P.78 to 79
	Dimensions	P.97 to 105	P.97 to 105	P.97 to 105

Our stepping motors generally support one of two connection methods, called "Pentagon" and "New Pentagon." See each motor's specifications for details.

Stepping Motor P.84 -

Connection Method: Pentagon

Basic step angle	Motor size	Holding torque (N · m)	Model Number	Page	
				Specifications and Characteristics	Dimensions
0.36°	39mm sq. (1.54inch sq.)	0.078 to 0.167	103-45 □□ -70 □ 0	P.84	P.97
0.45°	φ 60mm (φ 2.36inch)	0.91	103-7566-70 □ 1	P.85	P.99
0.72°	28mm sq. (1.10inch sq.)	0.041 to 0.085	SH528 □ - □ 0 □ 1	P.86	P.97
0.72°	42mm sq. (1.65inch sq.)	0.127 to 0.255	103H55 □□ -70 □ 0	P.87	P.97
0.72°	50mm sq. (1.97inch sq.)	0.225 to 0.39	103H650 □ - □ 0 □ 1	P.88	P.98
0.72°	60mm sq. (2.36inch sq.)	0.65 to 1.86	103H785 □ - □ 0 □ 1	P.89	P.98
0.72°	φ 60mm (φ 2.36inch)	0.46 to 1.568	103H752 □ - □ 0 □ 1	P.90	P.99
0.72°	φ 86mm (φ 3.39inch)	2.06 to 6.17	103H858 □ - □ 0 □ 1	P.91	P.99
0.72°	φ 106mm (φ 4.17inch)	10.8 to 16	103H8958 □ - □ 0 □ 1	P.92	P.100

Linear Actuator Stepping Motor P.95 -

Connection Method: New Pentagon

Motor size	Brake	Rated current (A/phase)	Thrust (N)	Speed (mm/s)	Model number	Page	
						Specifications and Characteristics	Dimensions
42mm sq. (1.65inch sq.)	Without	0.75	370	48	SL5421-7241	P.95	P.106
	With	0.75	370	48	SL5421-72XB41	P.95	P.106
60mm sq. (2.36inch sq.)	Without	1.4	450	64	SL5601-8241	P.95	P.106
	With	1.4	450	64	SL5601-82XB41	P.95	P.106

Stepping motor for vacuum environment P.96

This motor is customized for use in systems operating in vacuum environments.
Supports wide pressure range for low, high and ultra-high vacuums.

- Encoder-equipped motors are available upon request.

AC input Set model Micro step

Set Model Configuration ▶ P.10
 Specifications · Characteristics ▶ P.12 to 27
 Motor specifications ▶ P.28 Driver specifications ▶ P.29
 Motor dimensions ▶ P.97 to 104 Driver dimensions ▶ P.105



Features

- The auto-micro function provides low vibration and smooth drive even with coarse resolution setting of one or two divisions (full-/half-step), and supports micro steps of 250 divisions.
- Status and alarms are displayed instantly on the driver's two-digit alphanumeric LEDs.

Set model configuration items

Driver CE cULus

Model number : FS1W075P00
 Power supply : Single phase AC100V to 230V

Motor CE cULus CE/UL models comply with the respective safety standards.

Motor size : 42mm sq. (1.65inch sq.), 60mm sq. (2.36inch sq.),
 φ86mm (φ3.39inch), φ106mm (φ4.17inch)

Connector Power supply, Input/output signal, Motor

- Instruction manuals can be downloaded from our website.
- Cables for motor power and input/output signals (with connectors) are sold as options.

System configuration

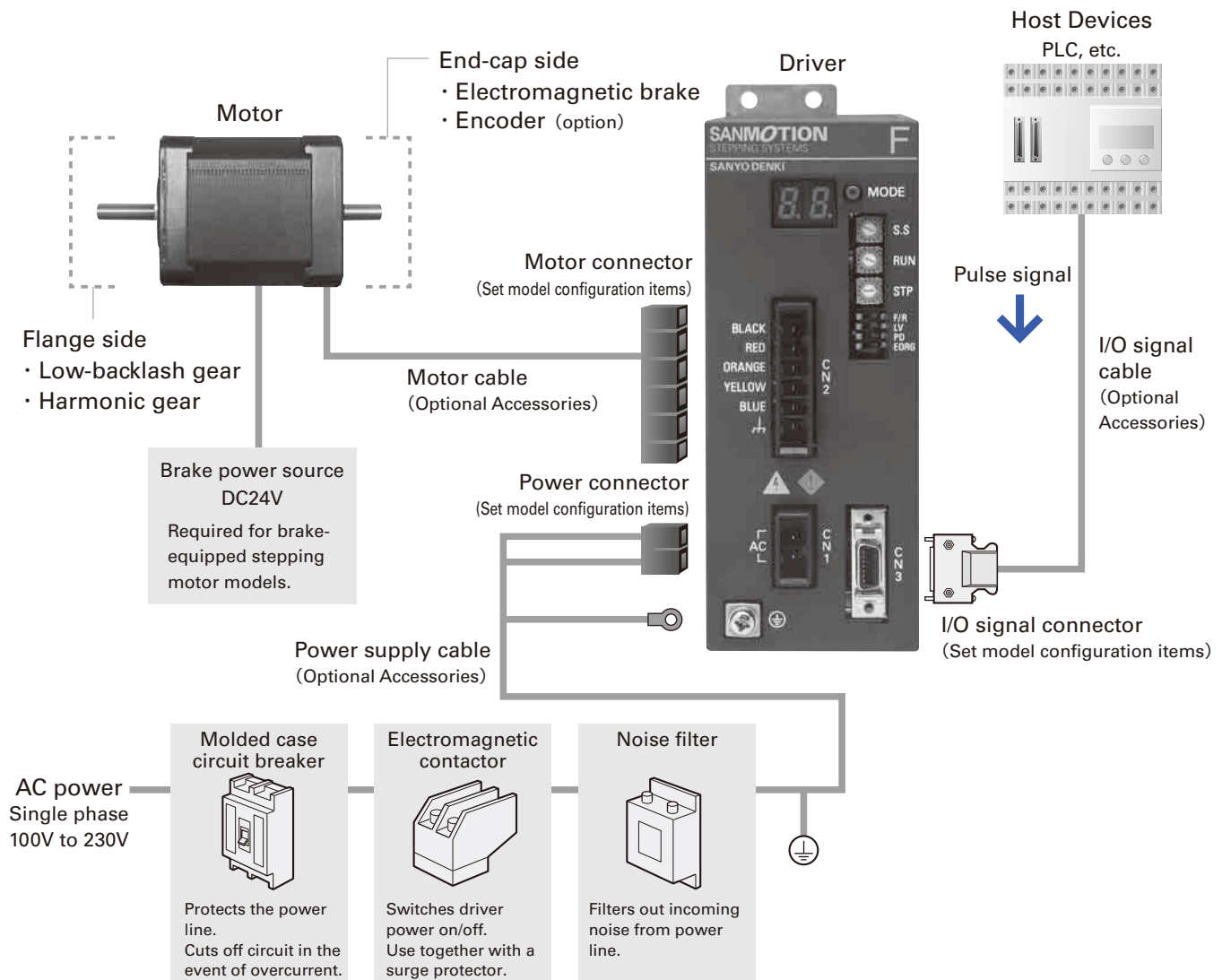

Model number convention

Example: The model number of the set with an AC driver and motor model 103F7851-70CXA4 is composed as follows.
 This motor is specified as 60mm sq. (2.36inch sq.) and 92mm (3,62inch) long (motor + gear), single shaft, with low backlash gears.

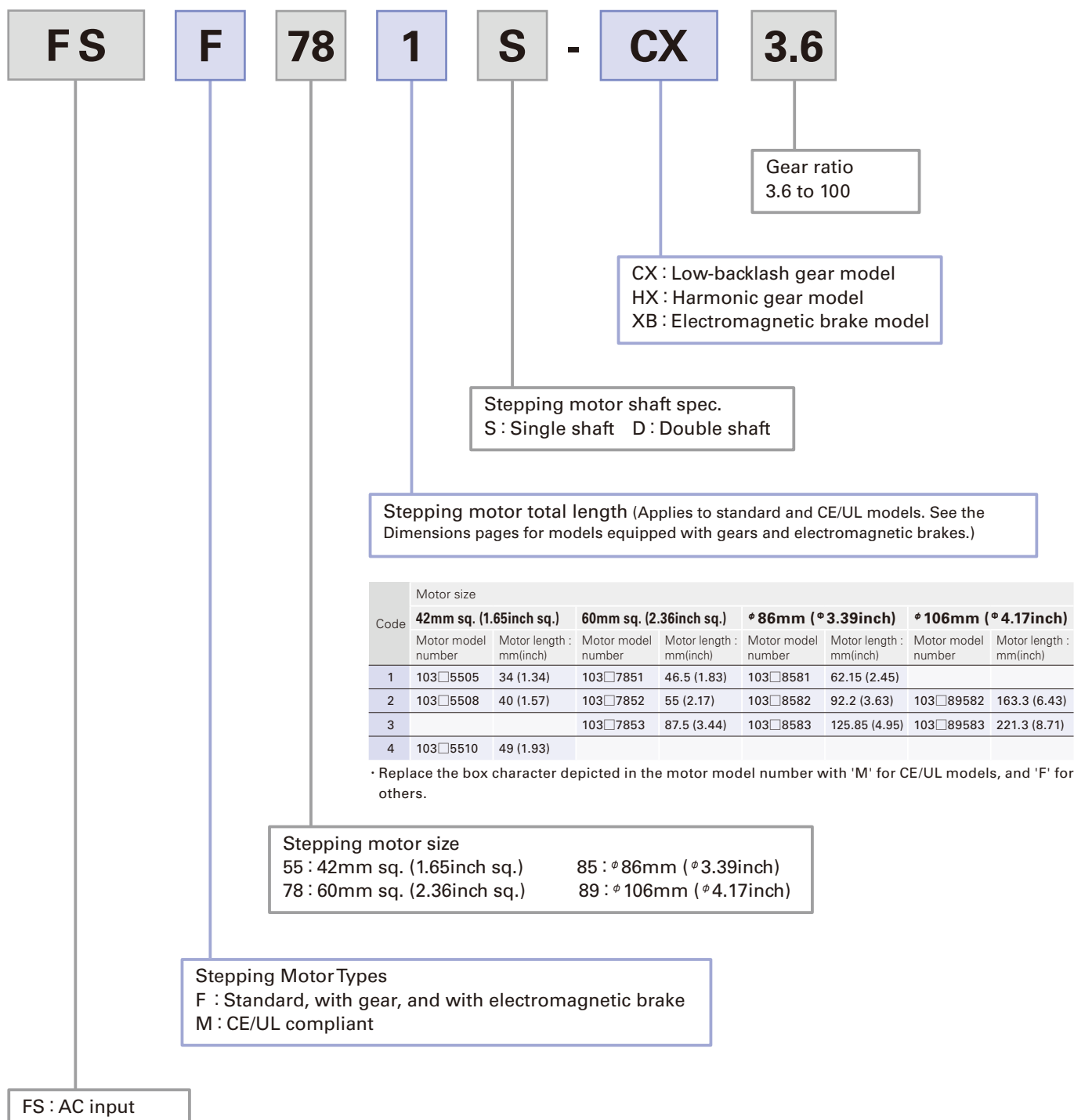

AC input Set model
Micro step

DC input Set model
Micro step

DC input Set model
Full / half step

Stepping Motor

Linear Actuator
Stepping Motor

Stepping motor for
vacuum environment

Dimensions

Set Model Configuration This is a set comprising a driver, motor and connectors.

AC Input Driver Model No. : FS1W075P00

Basic step angle : 0.72° Rated current : 0.75A/phase

Model	Motor size	Single shaft			Double shaft			Page		
		Set model number	Set model configuration items		Set model number	Set model configuration items		Specifi- cations	Dimen- sions	
			Motor model number	Connector number ^(note)		Motor model number	Connector number ^(note)			
Standard model	42mm sq. (1.65inch sq.)	FSF551S	103F5505-7041	PM-AP-065	FSF551D	103F5505-7011	PM-AP-065	P.12	P.97	
		FSF552S	103F5508-7041	PM-AP-065	FSF552D	103F5508-7011	PM-AP-065	P.12	P.97	
		FSF554S	103F5510-7041	PM-AP-065	FSF554D	103F5510-7011	PM-AP-065	P.12	P.97	
	60mm sq. (2.36inch sq.)	FSF781S	103F7851-7041	PM-AP-064	FSF781D	103F7851-7011	PM-AP-064	P.12	P.98	
		FSF782S	103F7852-7041	PM-AP-064	FSF782D	103F7852-7011	PM-AP-064	P.13	P.98	
		FSF783S	103F7853-7041	PM-AP-064	FSF783D	103F7853-7011	PM-AP-064	P.13	P.98	
	φ 86mm (* 3.39inch)	FSF851S	103F8581-7041	PM-AP-064	FSF851D	103F8581-7011	PM-AP-064	P.13	P.99	
		FSF852S	103F8582-7041	PM-AP-064	FSF852D	103F8582-7011	PM-AP-064	P.13	P.99	
		FSF853S	103F8583-7041	PM-AP-064	FSF853D	103F8583-7011	PM-AP-064	P.14	P.99	
	φ 106mm (* 4.17inch)	FSF892S	103F89582-7041	PM-AP-063	FSF892D	103F89582-7011	PM-AP-063	P.14	P.100	
		FSF893S	103F89583-7041	PM-AP-063	FSF893D	103F89583-7011	PM-AP-063	P.14	P.100	
CE / UL model	42mm sq. (1.65inch sq.)	FSM551S	103M5505-7041	PM-AP-065	FSM551D	103M5505-7011	PM-AP-065	P.15	P.97	
		FSM552S	103M5508-7041	PM-AP-065	FSM552D	103M5508-7011	PM-AP-065	P.15	P.97	
		FSM554S	103M5510-7041	PM-AP-065	FSM554D	103M5510-7011	PM-AP-065	P.15	P.97	
	60mm sq. (2.36inch sq.)	FSM781S	103M7851-7041	PM-AP-064	FSM781D	103M7851-7011	PM-AP-064	P.15	P.98	
		FSM782S	103M7852-7041	PM-AP-064	FSM782D	103M7852-7011	PM-AP-064	P.16	P.98	
		FSM783S	103M7853-7041	PM-AP-064	FSM783D	103M7853-7011	PM-AP-064	P.16	P.98	
	φ 86mm (* 3.39inch)	FSM851S	103M8581-7041	PM-AP-064	FSM851D	103M8581-7011	PM-AP-064	P.16	P.99	
		FSM852S	103M8582-7041	PM-AP-064	FSM852D	103M8582-7011	PM-AP-064	P.16	P.99	
		FSM853S	103M8583-7041	PM-AP-064	FSM853D	103M8583-7011	PM-AP-064	P.17	P.99	
	φ 106mm (* 4.17inch)	FSM892S	103M89582-7041	PM-AP-063	FSM892D	103M89582-7011	PM-AP-063	P.17	P.100	
		FSM893S	103M89583-7041	PM-AP-063	FSM893D	103M89583-7011	PM-AP-063	P.17	P.100	
Low-backlash gear model	42mm sq. (1.65inch sq.)	FSF551S-CX3.6	103F5505-70CXA4	PM-AP-065	FSF551D-CX3.6	103F5505-70CXA1	PM-AP-065	P.18	P.101	
		FSF551S-CX7.2	103F5505-70CXB4	PM-AP-065	FSF551D-CX7.2	103F5505-70CXB1	PM-AP-065	P.18	P.101	
		FSF551S-CX10	103F5505-70CXE4	PM-AP-065	FSF551D-CX10	103F5505-70CXE1	PM-AP-065	P.18	P.101	
		FSF551S-CX20	103F5505-70CXG4	PM-AP-065	FSF551D-CX20	103F5505-70CXG1	PM-AP-065	P.18	P.101	
		FSF551S-CX30	103F5505-70CXJ4	PM-AP-065	FSF551D-CX30	103F5505-70CXJ1	PM-AP-065	P.19	P.101	
		FSF551S-CX36	103F5505-70CCK4	PM-AP-065	FSF551D-CX36	103F5505-70CCK1	PM-AP-065	P.19	P.101	
	60mm sq. (2.36inch sq.)	FSF781S-CX3.6	103F7851-70CXA4	PM-AP-064	FSF781D-CX3.6	103F7851-70CXA1	PM-AP-064	P.19	P.101	
		FSF781S-CX7.2	103F7851-70CXB4	PM-AP-064	FSF781D-CX7.2	103F7851-70CXB1	PM-AP-064	P.19	P.101	
		FSF781S-CX10	103F7851-70CXE4	PM-AP-064	FSF781D-CX10	103F7851-70CXE1	PM-AP-064	P.20	P.101	
		FSF781S-CX20	103F7851-70CXG4	PM-AP-064	FSF781D-CX20	103F7851-70CXG1	PM-AP-064	P.20	P.101	
		FSF781S-CX30	103F7851-70CXJ4	PM-AP-064	FSF781D-CX30	103F7851-70CXJ1	PM-AP-064	P.20	P.101	
		FSF781S-CX36	103F7851-70CCK4	PM-AP-064	FSF781D-CX36	103F7851-70CCK1	PM-AP-064	P.20	P.101	
	φ 86mm (* 3.39inch)	FSF851S-CX3.6	103F8581-70CXA4	PM-AP-064	FSF851D-CX3.6	103F8581-70CXA1	PM-AP-064	P.21	P.101	
		FSF851S-CX7.2	103F8581-70CXB4	PM-AP-064	FSF851D-CX7.2	103F8581-70CXB1	PM-AP-064	P.21	P.101	
		FSF851S-CX10	103F8581-70CXE4	PM-AP-064	FSF851D-CX10	103F8581-70CXE1	PM-AP-064	P.21	P.101	
		FSF851S-CX20	103F8581-70CXG4	PM-AP-064	FSF851D-CX20	103F8581-70CXG1	PM-AP-064	P.21	P.101	
		FSF851S-CX30	103F8581-70CXJ4	PM-AP-064	FSF851D-CX30	103F8581-70CXJ1	PM-AP-064	P.22	P.101	
		FSF851S-CX36	103F8581-70CCK4	PM-AP-064	FSF851D-CX36	103F8581-70CCK1	PM-AP-064	P.22	P.101	
	Harmonic gear model	42mm sq. (1.65inch sq.)	FSF551S-HX30	103F5505-70HXJ5	PM-AP-065	FSF551D-HX30	103F5505-70HXJ2	PM-AP-065	P.23	P.102
			FSF551S-HX50	103F5505-70HXL5	PM-AP-065	FSF551D-HX50	103F5505-70HXL2	PM-AP-065	P.23	P.102
			FSF551S-HX100	103F5505-70HXM5	PM-AP-065	FSF551D-HX100	103F5505-70HXM2	PM-AP-065	P.23	P.102
		60mm sq. (2.36inch sq.)	FSF781S-HX50	103F7851-70HXL4	PM-AP-064	FSF781D-HX50	103F7851-70HXL1	PM-AP-064	P.23	P.103
			FSF781S-HX100	103F7851-70HXM4	PM-AP-064	FSF781D-HX100	103F7851-70HXM1	PM-AP-064	P.24	P.103
Electromagnetic brake model	42mm sq. (1.65inch sq.)	FSF551S-XB	103F5505-70XB41	PM-AP-065	—	—	—	P.25	P.104	
		FSF552S-XB	103F5508-70XB41	PM-AP-065	—	—	—	P.25	P.104	
		FSF554S-XB	103F5510-70XB41	PM-AP-065	—	—	—	P.25	P.104	
	60mm sq. (2.36inch sq.)	FSF781S-XB	103F7851-70XB41	PM-AP-064	—	—	—	P.25	P.104	
		FSF782S-XB	103F7852-70XB41	PM-AP-064	—	—	—	P.26	P.104	
		FSF783S-XB	103F7853-70XB41	PM-AP-064	—	—	—	P.26	P.104	
φ 86mm (* 3.39inch)	FSF851S-XB	103F8581-70XB41	PM-AP-064	—	—	—	P.26	P.104		
	FSF852S-XB	103F8582-70XB41	PM-AP-064	—	—	—	P.26	P.104		
	FSF853S-XB	103F8583-70XB41	PM-AP-064	—	—	—	P.27	P.104		

(Note) : A set of connectors (for power, and input/output signals) for the driver and motor are included in each set configuration.

Connector number	Driver connector set model number	Motor connector model number
PM-AP-065		4835758-1
PM-AP-064	PM-AP-078	4837994-1
PM-AP-063		4838971-1

Connector Set - Housing/Contact List

Driver connector set model number	Connector type	Housing model number (Manufacturer)	Contact model number (Manufacturer)
PM-AP-078	power connector	1-178128-2 (AMP)	1-175218-5 (AMP)
	I/O signal connector	10314-52A0-008 (3M)	10114-3000PE (3M)

Motor connector model number	Housing model number (Manufacturer)	Contact model number (Manufacturer)	Applicable motor sizes
4835758-1	1-178128-6 (AMP)	1-175216-5 (AMP)	42mm sq. (1.65inch sq.)
4837994-1	1-178128-6 (AMP)	1-175217-5 (AMP)	60mm sq. (2.36inch sq.), ϕ 86mm (ϕ 3.39inch)
4838971-1	1-178128-6 (AMP)	1-175218-5 (AMP)	ϕ 106mm (ϕ 4.17inch)

Optional Accessories

Cables have connector at driver end.

Power cable

Cable length (L)	Model number
10m	PM-C03P1000-05
5m	PM-C03P0500-05
3m	PM-C03P0300-05
1m	PM-C03P0100-05

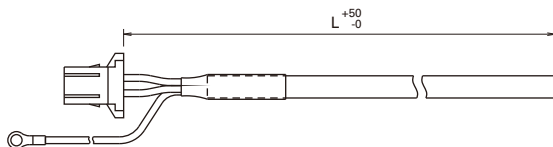

Lead wire	600V vinyl cab tire cable 3-core AWG16 (1.25mm ²)
Housing	1-178128-2 (AMP)
Contact	1-175218-5 (AMP)
Round-type crimp contact	1.25M4 (J.S.T. Mfg Co.)

• Cables 10m (32.81 feet) or longer are available upon request.

Motor cable

Cable length (L)	Model number
10m	PM-C06M1000-11
5m	PM-C06M0500-11
3m	PM-C06M0300-11
1m	PM-C06M0100-11

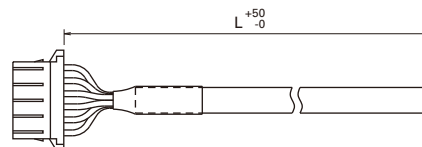

Lead wire	600V vinyl cab tire cable 6-core AWG18 (0.75mm ²)
Housing	1-178128-6 (AMP)
Contact	1-175218-5 (AMP)
Round-type crimp contact	1.25M4 (J.S.T. Mfg Co.)

• Cables 10m (32.81 feet) or longer are available upon request.

I/O signal cable

Cable length (L)	Model number
2m	PM-C14S0200-03
1m	PM-C14S0100-03

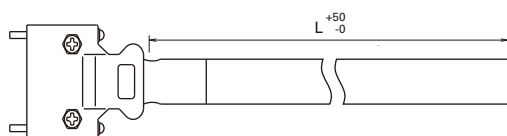

Lead wire	7-pair PVC shielded cable AWG28 (0.08mm ²)
Shell	10314-52A0-008 (3M)
Plug	10114-3000PE (3M)

Standard model AC input Driver (Model number : FS1W075P00) + Standard motor

Basic step angle : 0.72° Rated current : 0.75A/phase

Motor size		42mm sq. (1.65inch sq.)			60mm sq. (2.36inch sq.)
Motor length		34mm (1.34inch)	40mm (1.57inch)	49mm (1.93inch)	46.5mm (1.83inch)
Single shaft	Set ordering model no.	FSF551S	FSF552S	FSF554S	FSF781S
	Corresponding motor model number	103F5505-7041	103F5508-7041	103F5510-7041	103F7851-7041
Double shaft	Set ordering model no.	FSF551D	FSF552D	FSF554D	FSF781D
	Corresponding motor model number	103F5505-7011	103F5508-7011	103F5510-7011	103F7851-7011
Holding torque	N · m (OZ · in)	0.13 (18.41)	0.18 (25.49)	0.26 (36.82)	0.6 (85.0)
Rotor inertia	(OZ · in ²)	0.03 (0.16)	0.053 (0.29)	0.065 (0.36)	0.275 (1.50)
Motor mass ^(Note1)	kg (lbs)	0.23 (0.50)	0.28 (0.62)	0.37 (0.81)	0.6 (1.32)
Allowable thrust load	N (lbs)	10 (2.25)	10 (2.25)	10 (2.25)	20 (4.5)
Allowable radial load ^(Note2)	N (lbs)	35 (8.75)	35 (8.75)	35 (8.75)	80 (18)

(Note1) Driver mass ▶ P.29

(Note2) When load is applied at 1/3 length from output shaft edge.

Characteristics

Operating current : 0.75A/phase
Use the rubber coupling

Pull-out torque Source current (no load) Full step Half step fs : Maximum self-start frequency when not loaded Full step Half step
Source current (load applied) Full step Half step

FSF551S FSF551D

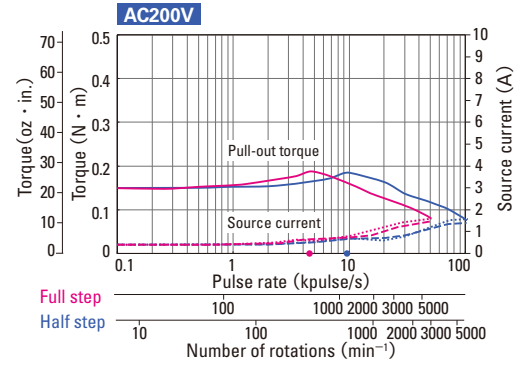
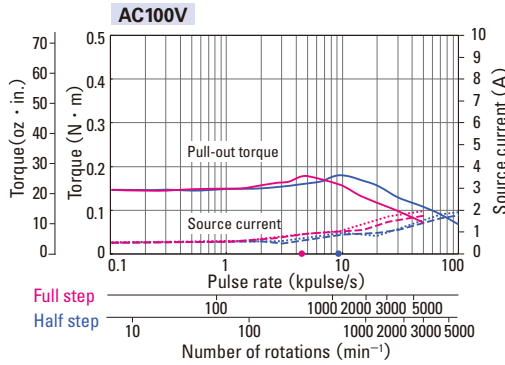

FSF552S FSF552D

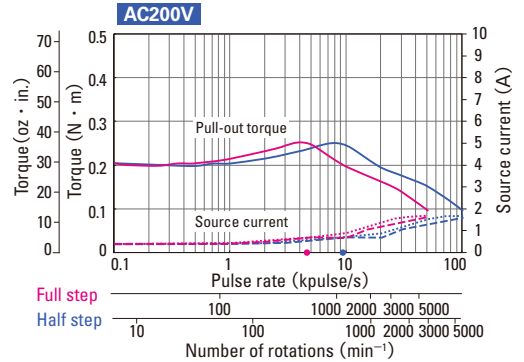
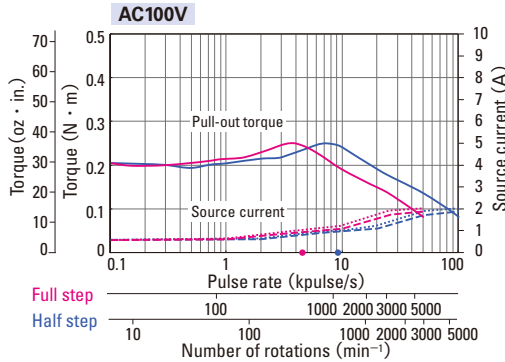

FSF554S FSF554D

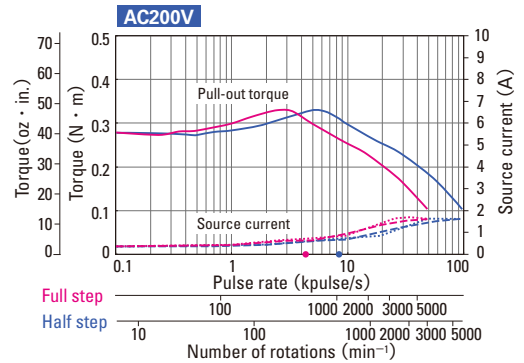
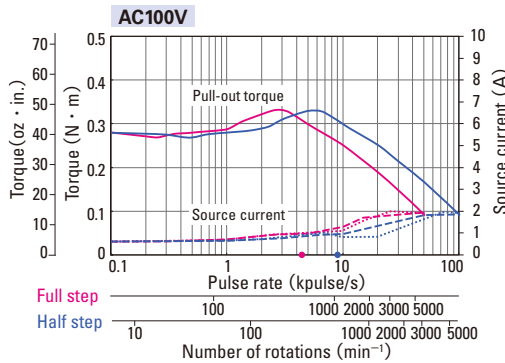

FSF781S FSF781D

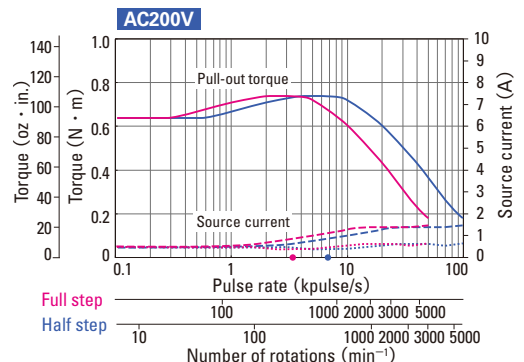
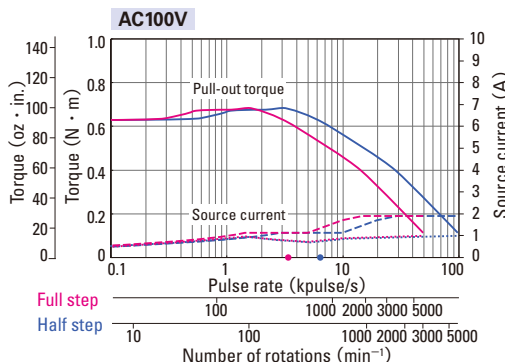

System configuration ▶ P.8 Set Model Configuration ▶ P.10 Motor dimensions ▶ P.97 to 100 Driver dimensions ▶ P.105 The data are measured under the drive condition of our company. The drive torque may vary depending on the accuracy of customer-side equipment.

Motor size		60mm sq. (2.36inch sq.)		φ86mm (φ3.39inch)	
Motor length		55mm (2.17inch)	87.5mm (3.45inch)	62.15mm (2.47inch)	92.2mm (3.63inch)
Single shaft	Set ordering model no.	FSF782S	FSF783S	FSF851S	FSF852S
	Corresponding motor model number	103F7852-7041	103F7853-7041	103F8581-7041	103F8582-7041
Double shaft	Set ordering model no.	FSF782D	FSF783D	FSF851D	FSF852D
	Corresponding motor model number	103F7852-7011	103F7853-7011	103F8581-7011	103F8582-7011
Holding torque	N · m (OZ · in)	0.93 (131.7)	1.79 (253.5)	2.06 (291.7)	4.02 (569.3)
Rotor inertia	$\times 10^{-4}$ kg · m ² (OZ · in ²)	0.4 (2.19)	0.84 (4.60)	1.45 (7.93)	2.9 (15.86)
Motor mass ^(Note1)	kg (lbs)	0.78 (1.72)	1.36 (3.0)	1.5 (3.3)	2.5 (5.5)
Allowable thrust load	N (lbs)	20 (4.5)	20 (4.5)	60 (13.5)	60 (13.5)
Allowable radial load ^(Note2)	N (lbs)	80 (18)	80 (18)	220 (49.5)	220 (49.5)

(Note1) Driver mass ▶ P.29

(Note2) When load is applied at 1/3 length from output shaft edge.

Characteristics

Operating current : 0.75A/phase
Use the rubber coupling

Pull-out torque Full step Half step fs : Maximum self-start frequency when not loaded Full step Half step
Source current (no load) Full step Half step Source current (load applied) Full step Half step

FSF782S FSF782D

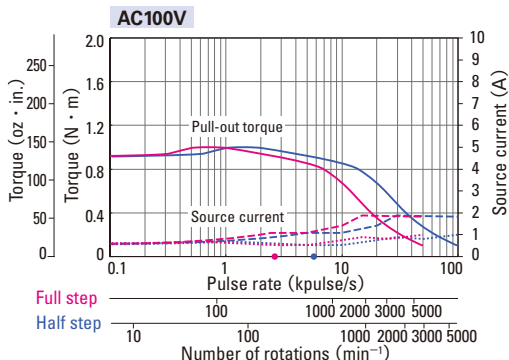

AC200V

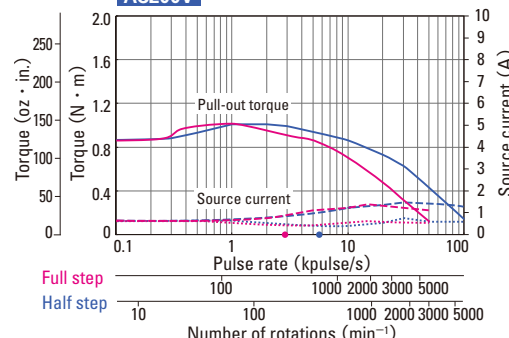

FSF783S FSF783D

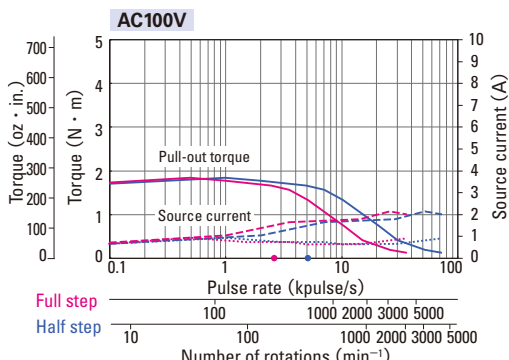

AC200V

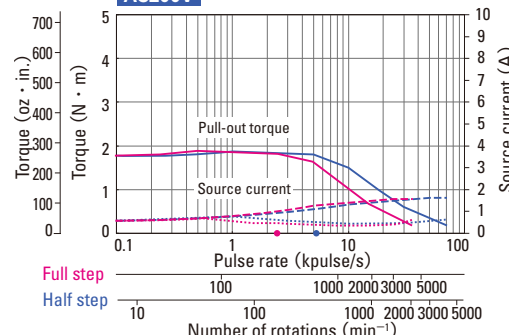

FSF851S FSF851D

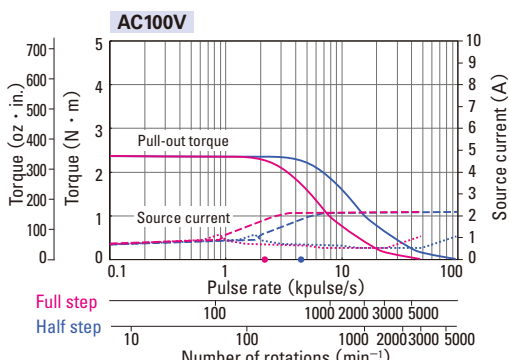

AC200V

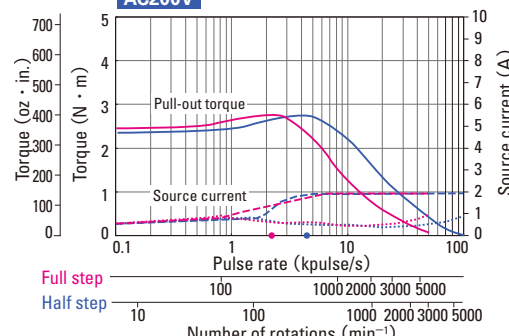

FSF852S FSF852D

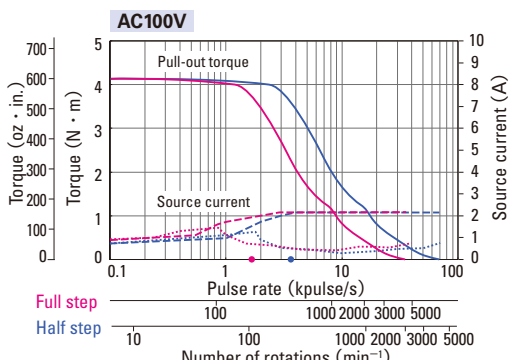

AC200V

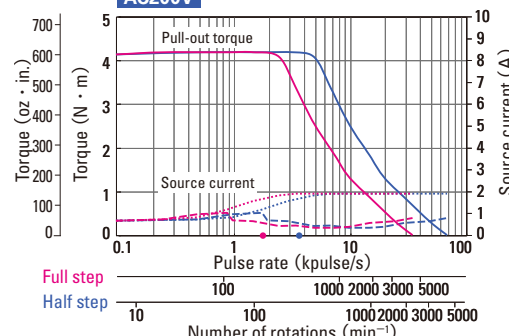

Standard model AC input Driver (Model number : FS1W075P00) + Standard motor

Basic step angle : 0.72° Rated current : 0.75A/phase

Motor size		φ86mm (φ3.39inch)	φ106mm (φ4.17inch)	
Motor length		125.85mm (4.95inch)	163.3mm (6.43inch)	221.3mm (8.71inch)
Single shaft	Set ordering model no.	FSF853S	FSF892S	FSF893S
	Corresponding motor model number	103F8583-7041	103F89582-7041	103F89583-7041
Double shaft	Set ordering model no.	FSF853D	FSF892D	FSF893D
	Corresponding motor model number	103F8583-7011	103F89582-7011	103F89583-7011
Holding torque	N · m (OZ · in)	6.17 (873.7)	10.8 (1529.4)	16 (2265.7)
Rotor inertia	$\times 10^{-4} \text{kg} \cdot \text{m}^2 (\text{OZ} \cdot \text{in}^2)$	4.4 (24.06)	14.6 (79.83)	22 (120.28)
Motor mass ^(Note1)	kg (lbs)	3.5 (7.7)	7.5 (16.5)	10.5 (23.1)
Allowable thrust load	N (lbs)	60 (13.5)	100 (22.5)	100 (22.5)
Allowable radial load ^(Note2)	N (lbs)	220 (49.5)	360 (81)	360 (81)

(Note1) Driver mass ▶ P.29

(Note2) When load is applied at 1/3 length from output shaft edge.

Characteristics

Operating current : 0.75A/phase
Use the rubber coupling

Pull-out torque Source current (no load) Full step Half step fs : Maximum self-start frequency when not loaded Full step Half step
Source current (load applied) Full step Half step

FSF853S FSF853D

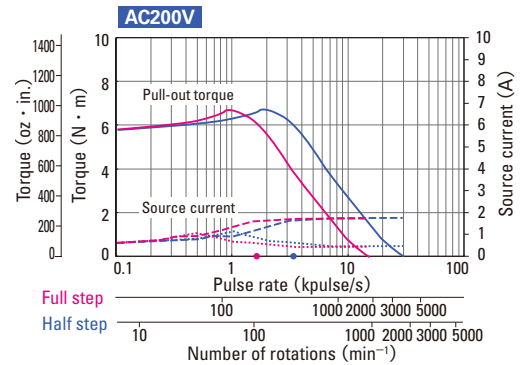
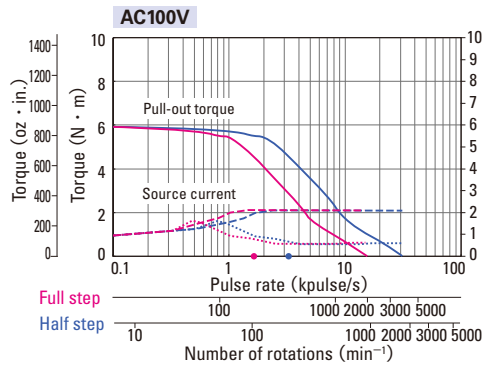

FSF892S FSF892D

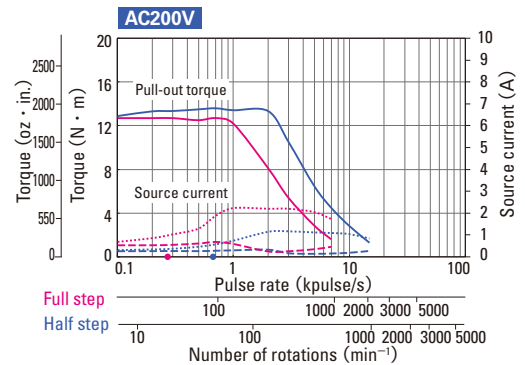
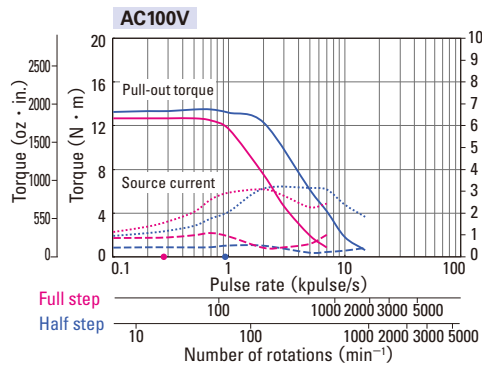

FSF893S FSF893D

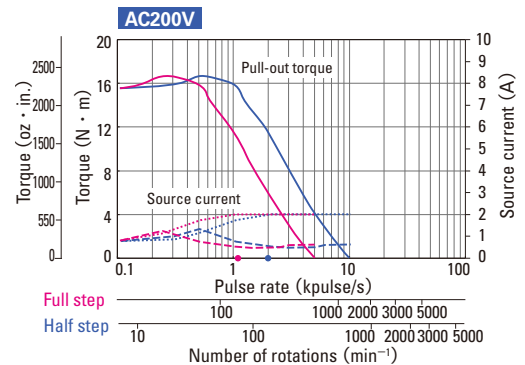
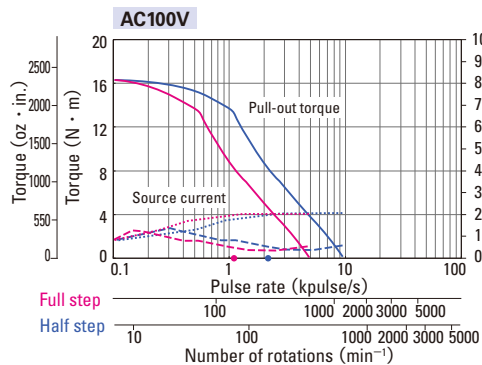

CE / UL model AC input Driver (Model number : FS1W075P00) + CE/UL Compliant Motor

Basic step angle : 0.72° Rated current : 0.75A/phase

Motor size		42mm sq. (1.65inch sq.)			60mm sq.(2.36inch sq.)
Motor length		34mm (1.34inch)	40mm (1.57inch)	49mm (1.93inch)	46.5mm (1.83inch)
Single shaft	Set ordering model no.	FSM551S	FSM552S	FSM554S	FSM781S
	Corresponding motor model number	103M5505-7041	103M5508-7041	103M5510-7041	103M7851-7041
Double shaft	Set ordering model no.	FSM551D	FSM552D	FSM554D	FSM781D
	Corresponding motor model number	103M5505-7011	103M5508-7011	103M5510-7011	103M7851-7011
Holding torque	N · m (OZ · in)	0.13 (18.41)	0.18 (25.49)	0.26 (36.82)	0.6 (85.0)
Rotor inertia	$\times 10^{-4}$ kg · m ² (OZ · in ²)	0.03 (0.16)	0.053 (0.29)	0.065 (0.36)	0.275 (1.50)
Motor mass ^(Note1)	kg (lbs)	0.23 (0.51)	0.28 (0.62)	0.37 (0.81)	0.6 (1.32)
Allowable thrust load	N (lbs)	10 (2.25)	10 (2.25)	10 (2.25)	20 (4.5)
Allowable radial load ^(Note2)	N (lbs)	35 (8.75)	35 (8.75)	35 (8.75)	80 (18)

(Note1) Driver mass ▶ P.29

(Note2) When load is applied at 1/3 length from output shaft edge.

Characteristics

Operating current : 0.75A/phase
Use the rubber coupling

Pull-out torque Source current (no load) Full step — Half step — fs : Maximum self-start frequency when not loaded Full step ● Half step ●
Source current (load applied) Full step - - - Half step - - -

FSM551S FSM551D

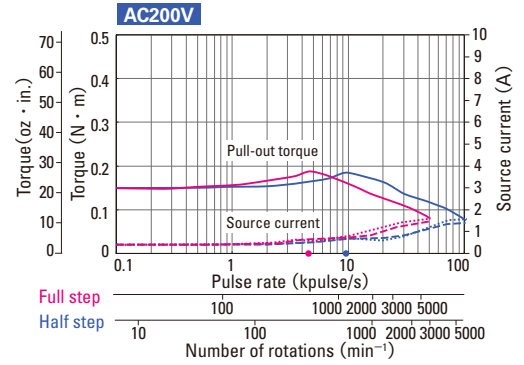
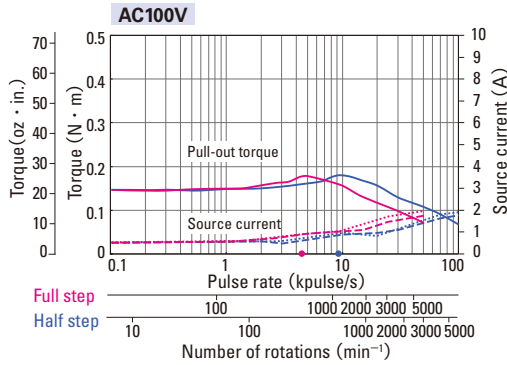

FSM552S FSM552D

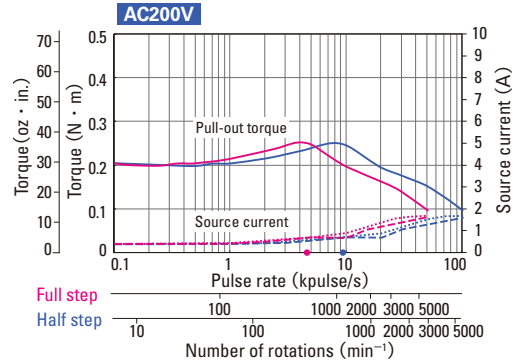
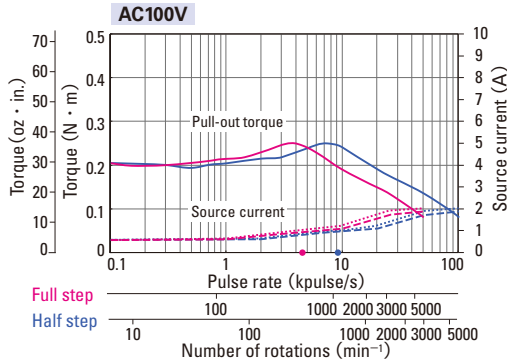

FSM554S FSM554D

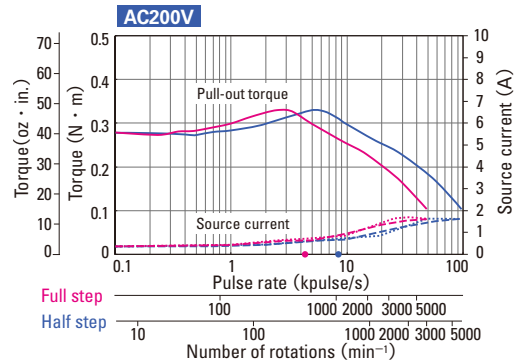
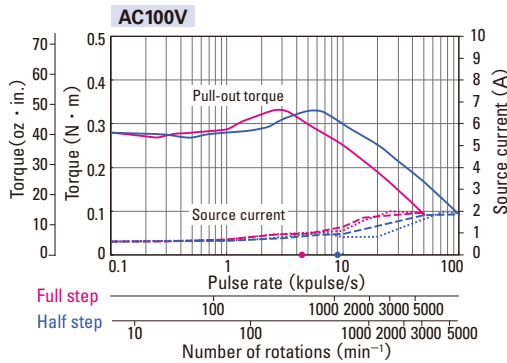

FSM781S FSM781D

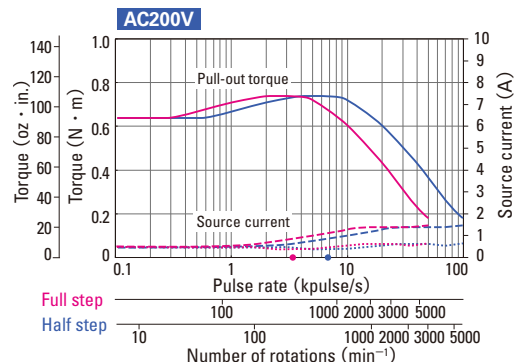
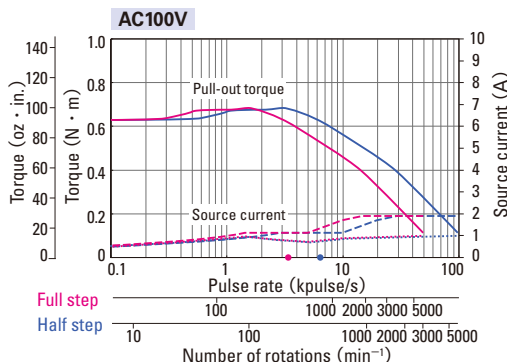

CE / UL model AC input Driver (Model number : FS1W075P00) + CE/UL Compliant Motor

Basic step angle : 0.72° Rated current : 0.75A/phase

Motor size		60mm sq. (2.36inch sq.)		φ86mm (φ3.39inch)	
		55mm (2.17inch)	87.5mm (3.44inch)	62.15mm (2.47inch)	92.2mm (3.63inch)
Single shaft	Set ordering model no.	FSM782S	FSM783S	FSM851S	FSM852S
	Corresponding motor model number	103M7852-7041	103M7853-7041	103M8581-7041	103M8582-7041
Double shaft	Set ordering model no.	FSM782D	FSM783D	FSM851D	FSM852D
	Corresponding motor model number	103M7852-7011	103M7853-7011	103M8581-7011	103M8582-7011
Holding torque	N · m (OZ · in)	0.93 (131.7)	1.79 (253.5)	2.06 (291.7)	4.02 (569.3)
Rotor inertia	$\times 10^{-4}$ kg · m ² (OZ · in ²)	0.4 (2.19)	0.84 (4.59)	1.45 (7.93)	2.9 (15.86)
Motor mass ^(Note1)	kg (lbs)	0.78 (1.72)	1.36 (3.0)	1.5 (3.3)	2.5 (5.5)
Allowable thrust load	N (lbs)	20 (4.5)	20 (4.5)	60 (13.5)	60 (13.5)
Allowable radial load ^(Note2)	N (lbs)	80 (18)	80 (18)	220 (49.5)	220 (49.5)

(Note1) Driver mass ▶ P.29

(Note2) When load is applied at 1/3 length from output shaft edge.

Characteristics

Operating current : 0.75A/phase
Use the rubber coupling

Pull-out torque Full step — Half step — fs : Maximum self-start frequency when not loaded Full step ● Half step ●
Source current (no load) Full step - - - Half step - - - Source current (load applied) Full step ····· Half step ·····

FSM782S FSM782D

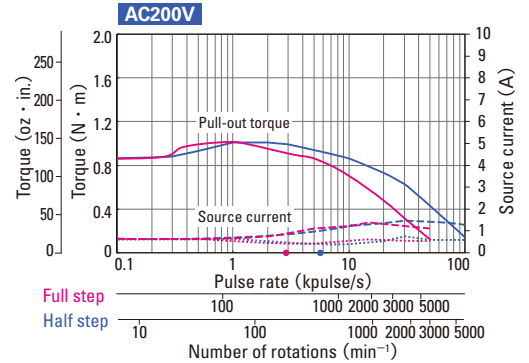
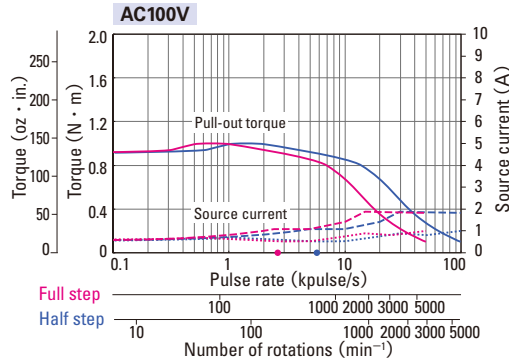

FSM783S FSM783D

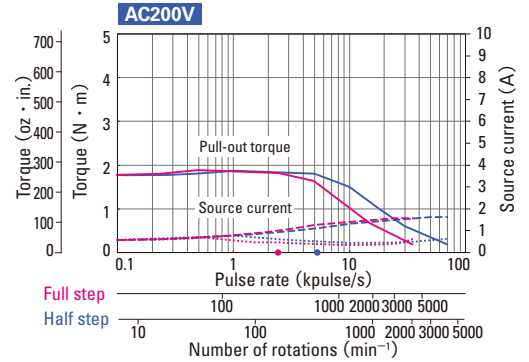
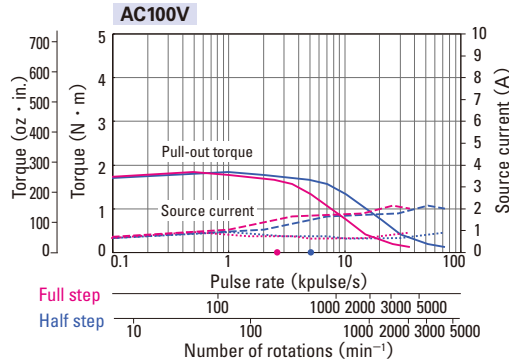

FSM851S FSM851D

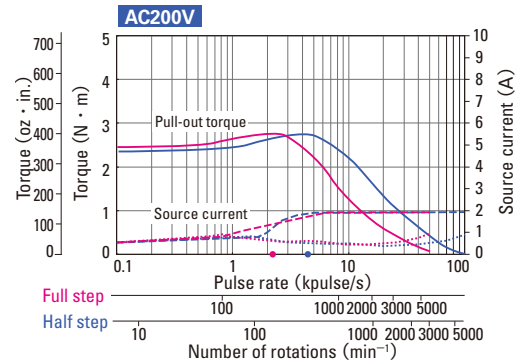
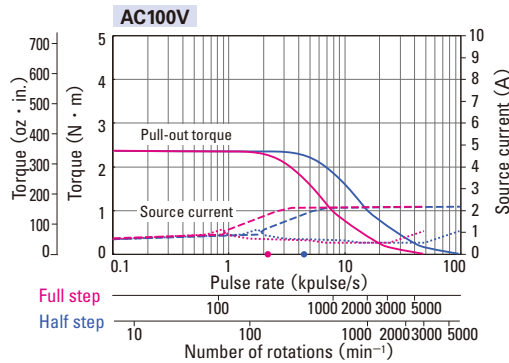

FSM852S FSM852D

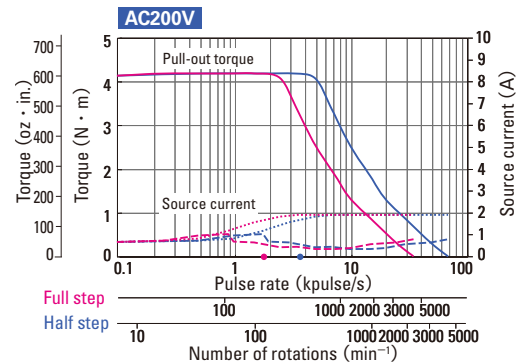
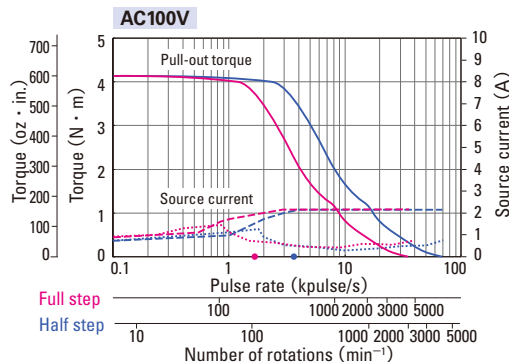

System configuration ▶ P.8 Set Model Configuration ▶ P.10 Motor dimensions ▶ P.97 to 100 Driver dimensions ▶ P.105 The data are measured under the drive condition of our company. The drive torque may vary depending on the accuracy of customer-side equipment.

Motor size		φ86mm (φ3.39inch)	φ106mm (φ4.17inch)	
Motor length		125.85mm (4.95inch)	163.3mm (6.43inch)	221.3mm (8.71inch)
Single shaft	Set ordering model no.	FSM853S	FSM892S	FSM893S
	Corresponding motor model number	103M8583-7041	103M89582-7041	103M89583-7041
Double shaft	Set ordering model no.	FSM853D	FSM892D	FSM893D
	Corresponding motor model number	103M8583-7011	103M89582-7011	103M89583-7011
Holding torque	N · m (OZ · in)	6.17 (873.7)	10.8 (1529.4)	16 (2265.7)
Rotor inertia	$\times 10^{-4} \text{kg} \cdot \text{m}^2$ (OZ · in ²)	4.4 (24.06)	14.6 (79.83)	22 (120.18)
Motor mass ^(Note1)	kg (lbs)	3.5 (7.7)	7.5 (16.5)	10.5 (23.1)
Allowable thrust load	N (lbs)	60 (13.5)	100 (22.5)	100 (22.5)
Allowable radial load ^(Note2)	N (lbs)	220 (49.5)	360 (81)	360 (81)

(Note1) Driver mass ▶ P.29

(Note2) When load is applied at 1/3 length from output shaft edge.

Characteristics

Operating current : 0.75A/phase
Use the rubber coupling

Pull-out torque Full step Half step fs : Maximum self-start frequency when not loaded Full step Half step
Source current (no load) Full step Half step Source current (load applied) Full step Half step

FSM853S FSM853D

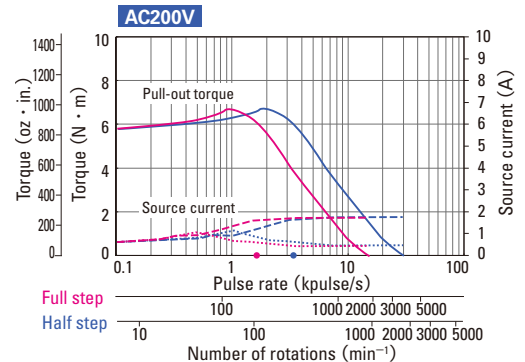
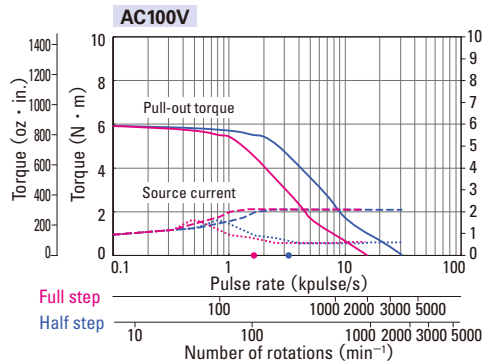

FSM892S FSM892D

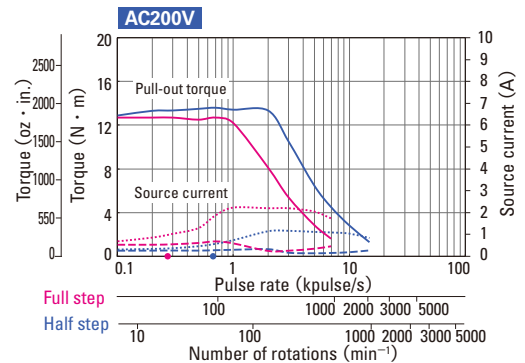
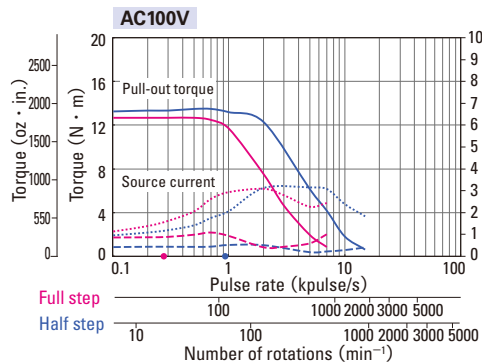

FSM893S FSM893D

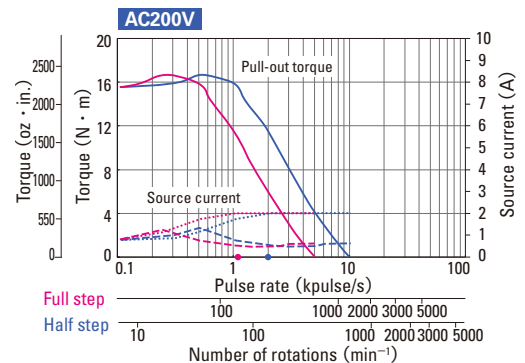
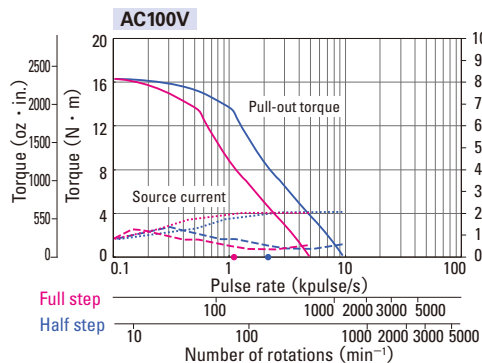

Low-backlash gear model

AC input Driver (Model number : FS1W075P00) + Motor with low-backlash gear

Rated current : 0.75A/phase

Motor size		42mm sq. (1.65inch sq.)			
Motor + gear length		64.5mm (2.54inch)	64.5mm (2.54inch)	64.5mm (2.54inch)	64.5mm (2.54inch)
Single shaft	Set ordering model no.	FSF551S-CX3.6	FSF551S-CX7.2	FSF551S-CX10	FSF551S-CX20
	Corresponding motor model number	103F5505-70CX4A	103F5505-70CXB4	103F5505-70CXE4	103F5505-70CXG4
Double shaft	Set ordering model no.	FSF551D-CX3.6	FSF551D-CX7.2	FSF551D-CX10	FSF551D-CX20
	Corresponding motor model number	103F5505-70CXA1	103F5505-70CXB1	103F5505-70CXE1	103F5505-70CXG1
Allowable torque	N · m (OZ · in)	0.343 (48.6)	0.686 (97.1)	0.98 (138.8)	1.47 (208.2)
Rotor inertia	$\times 10^{-4}$ kg · m ² (OZ · in ²)	0.03 (0.16)	0.03 (0.16)	0.03 (0.16)	0.03 (0.16)
Basic step angle	DEG	0.2	0.1	0.072	0.036
Gear ratio	-	1 : 3.6	1 : 7.2	1 : 10	1 : 20
Backlash	DEG	0.6	0.4	0.35	0.25
Allowable speed	min ⁻¹	500	250	180	90
Motor mass ^(Note1)	kg (lbs)	0.36 (0.79)	0.36 (0.79)	0.36 (0.79)	0.36 (0.79)
Allowable thrust load	N (lbs)	15 (3.38)	15 (3.38)	15 (3.38)	15 (3.38)
Allowable radial load ^(Note2)	N (lbs)	20 (4.5)	20 (4.5)	20 (4.5)	20 (4.5)

Directions of motor rotation and gear output shaft are the same for models with reduction ratio 1 : 3.6, 1 : 7.2 and 1 : 10 opposite for reduction ratio 1 : 20, 1 : 30, and 1 : 36.

(Note1) Driver mass ▶ P.29

(Note2) When load is applied at 1/3 length from output shaft edge.

Characteristics

Operating current : 0.75A/phase
Use the rubber coupling

Allowable torque Full step — Half step —
Source current (no load) Full step - - - Half step - - -
Source current (load applied) Full step Half step

FSF551S-CX3.6
FSF551D-CX3.6

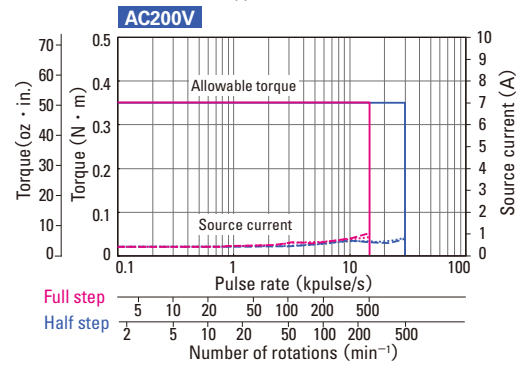
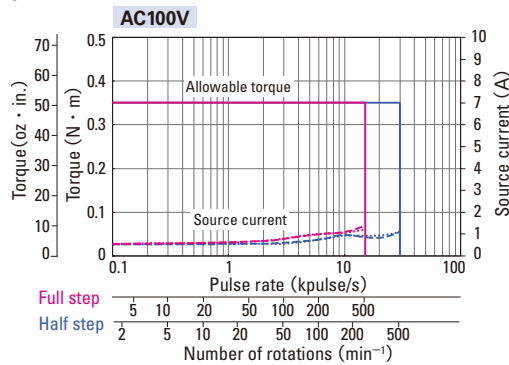

FSF551S-CX7.2
FSF551D-CX7.2

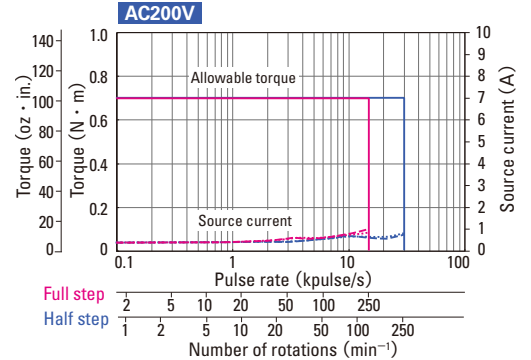
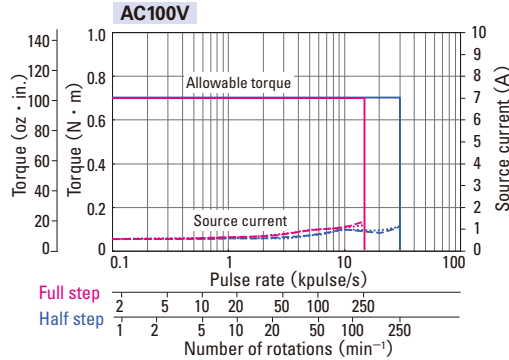

FSF551S-CX10
FSF551D-CX10

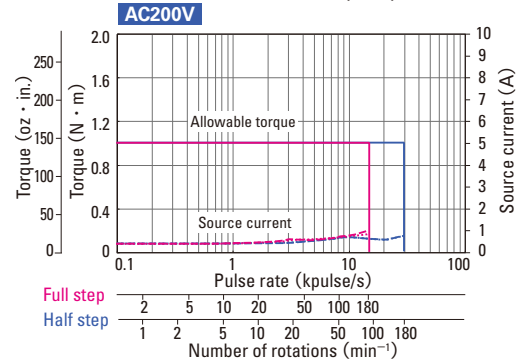
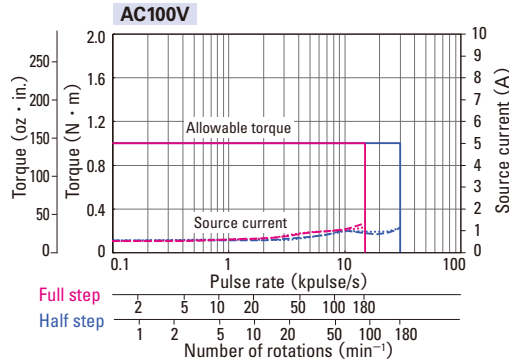

FSF551S-CX20
FSF551D-CX20

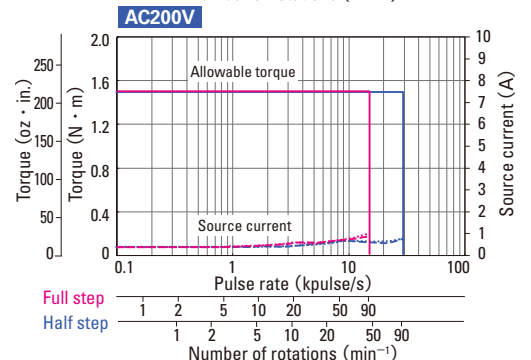
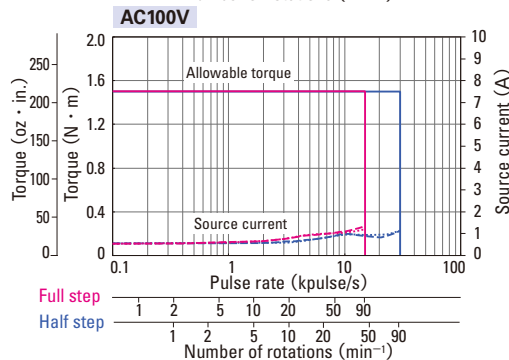

Motor size		42mm sq. (1.65inch sq.)		60mm sq. (2.36inch sq.)	
Motor + gear length		64.5mm (2.54inch)	64.5mm (2.54inch)	92mm (3.62inch)	92mm (3.62inch)
Single shaft	Set ordering model no.	FSF551S-CX30	FSF551S-CX36	FSF781S-CX3.6	FSF781S-CX7.2
	Corresponding motor model number	103F5505-70CXJ4	103F5505-70CCK4	103F7851-70CXA4	103F7851-70CXB4
Double shaft	Set ordering model no.	FSF551D-CX30	FSF551D-CX36	FSF781D-CX3.6	FSF781D-CX7.2
	Corresponding motor model number	103F5505-70CXJ1	103F5505-70CCK1	103F7851-70CXA1	103F7851-70CXB1
Allowable torque	N · m (OZ · in)	1.47 (208.2)	1.47 (208.2)	1.25 (177.0)	2.5 (354.0)
Rotor inertia	$\times 10^{-4} \text{kg} \cdot \text{m}^2$ (OZ · in ²)	0.03 (0.16)	0.03 (0.16)	0.275 (1.5)	0.275 (1.5)
Basic step angle	DEG	0.024	0.02	0.2	0.1
Gear ratio	-	1 : 30	1 : 36	1 : 3.6	1 : 7.2
Backlash	DEG	0.25	0.25	0.55	0.25
Allowable speed	min ⁻¹	60	50	500	250
Motor mass ^(Note1)	kg (lbs)	0.36 (0.79)	0.36 (0.79)	0.97 (2.13)	0.97 (2.13)
Allowable thrust load	N (lbs)	15 (3.38)	15 (3.38)	30 (6.75)	30 (6.75)
Allowable radial load ^(Note2)	N (lbs)	20 (4.5)	20 (4.5)	100 (22.5)	100 (22.5)

The directions of motor rotation and gear output axle rotation for 42 mm models are the same for 1:3.6, 1:7.2 and 1:10 reduction ratios, and opposite for 1:20, 1:30 and 1:36 reduction ratios. For 60 mm models, rotation directions are the same for 1:3.6 and 1:7.2 reduction ratios, and opposite for 1:10, 1:20, 1:30 and 1:36 reduction ratios.

(Note1) Driver mass ▶ P.29

(Note2) When load is applied at 1/3 length from output shaft edge.

Characteristics

Operating current : 0.75A/phase
Use the rubber coupling

Allowable torque Full step — Half step —
Source current (no load) Full step - - - Half step - - -

Source current (load applied) Full step ····· Half step ·····

FSF551S-CX30
FSF551D-CX30

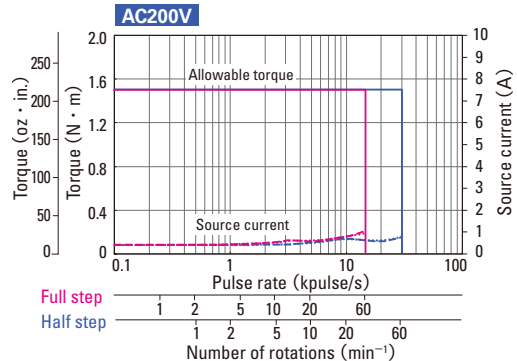
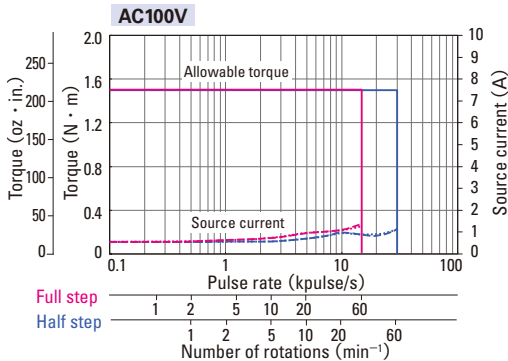

FSF551S-CX36
FSF551D-CX36

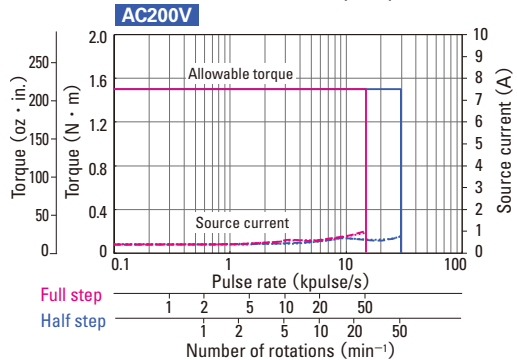
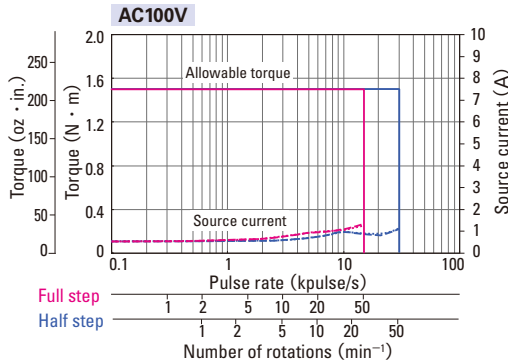

FSF781S-CX3.6
FSF781D-CX3.6

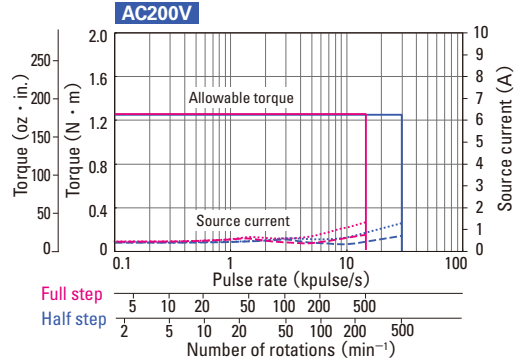
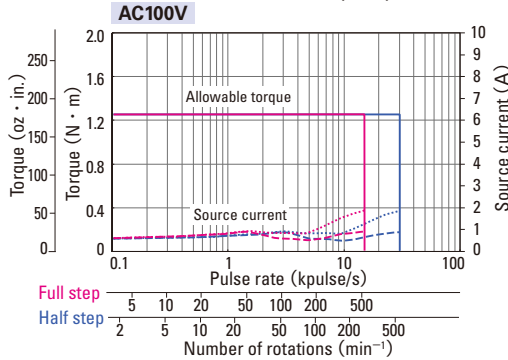

FSF781S-CX7.2
FSF781D-CX7.2

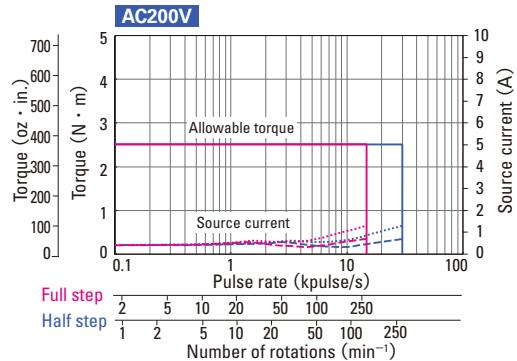
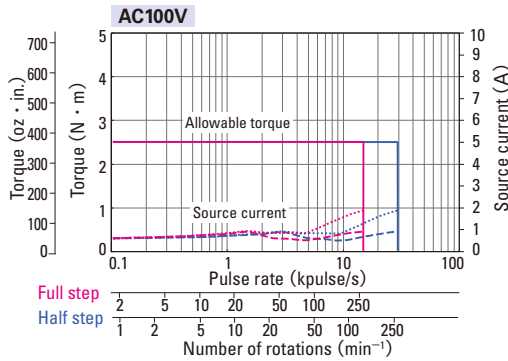

In motor+gear models, the gears may be damaged if allowable torque is exceeded. When selecting a motor, ensure that its allowable torque will not be exceeded. System configuration ▶ P.8 Set Model Configuration ▶ P.10 Motor dimensions ▶ P.101 Driver dimensions ▶ P.105 The data are measured under the drive condition of our company. The drive torque may very depending on the accuracy of customer-side equipment.

Low-backlash gear model

AC input Driver (Model number : FS1W075P00) + Motor with low-backlash gear

Rated current : 0.75A/phase

Motor size		60mm sq. (2.36inch sq.)			
Motor + gear length		92mm (3.62inch)	92mm (3.62inch)	92mm (3.62inch)	92mm (3.62inch)
Single shaft	Set ordering model no.	FSF781S-CX10	FSF781S-CX20	FSF781S-CX30	FSF781S-CX36
	Corresponding motor model number	103F7851-70CXE4	103F7851-70CXG4	103F7851-70CXJ4	103F7851-70CXK4
Double shaft	Set ordering model no.	FSF781D-CX10	FSF781D-CX20	FSF781D-CX30	FSF781D-CX36
	Corresponding motor model number	103F7851-70CXE1	103F7851-70CXG1	103F7851-70CXJ1	103F7851-70CXK1
Allowable torque	N · m (OZ · in)	3 (424.8)	3.5 (495.6)	4 (566.4)	4 (566.4)
Rotor inertia	$\times 10^{-4}$ kg · m ² (OZ · in ²)	0.275 (1.5)	0.275 (1.5)	0.275 (1.5)	0.275 (1.5)
Basic step angle	DEG	0.072	0.036	0.024	0.02
Gear ratio	-	1 : 10	1 : 20	1 : 30	1 : 36
Backlash	DEG	0.25	0.17	0.17	0.17
Allowable speed	min ⁻¹	180	90	60	50
Motor mass ^(Note1)	kg (lbs)	0.97 (2.13)	0.97 (2.13)	0.97 (2.13)	0.97 (2.13)
Allowable thrust load	N (lbs)	30 (6.75)	30 (6.75)	30 (6.75)	30 (6.75)
Allowable radial load ^(Note2)	N (lbs)	100 (22.5)	100 (22.5)	100 (22.5)	100 (22.5)

The directions of motor rotation and gear output axle rotation are the same for models with reduction ratio 1:3.6 and 1:7.2 reduction ratios, and opposite for 1:10, 1:20, 1:30 and 1:36 reduction ratios.

(Note1) Driver mass ▶ P.29

(Note2) When load is applied at 1/3 length from output shaft edge.

Characteristics

Operating current : 0.75A/phase
Use the rubber coupling

Allowable torque Full step — Half step —
Source current (no load) Full step - - - Half step - - -

Source current (load applied) Full step ····· Half step ·····

FSF781S-CX10
FSF781D-CX10

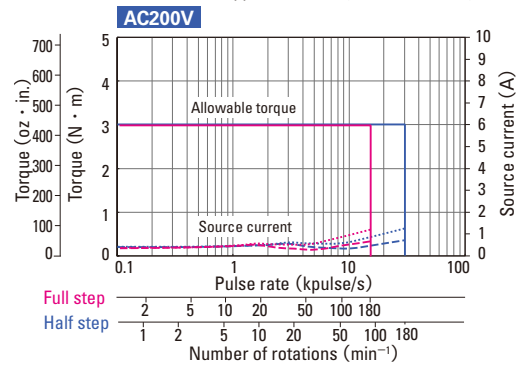
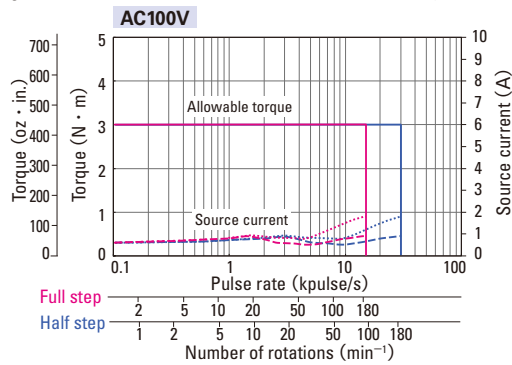

FSF781S-CX20
FSF781D-CX20

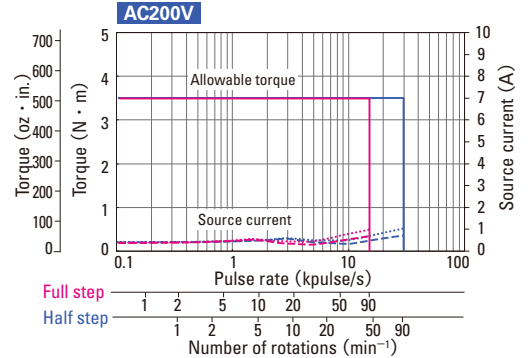
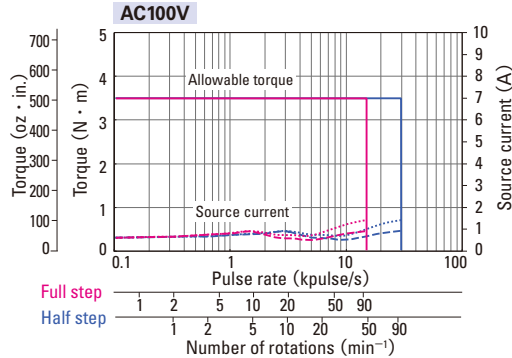

FSF781S-CX30
FSF781D-CX30

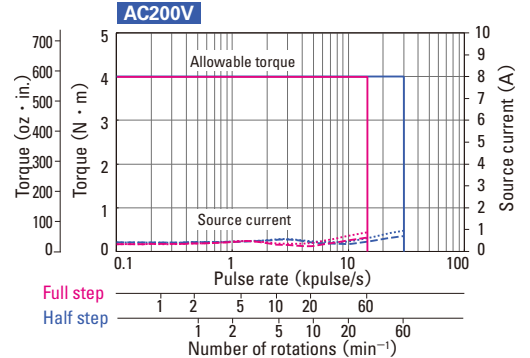
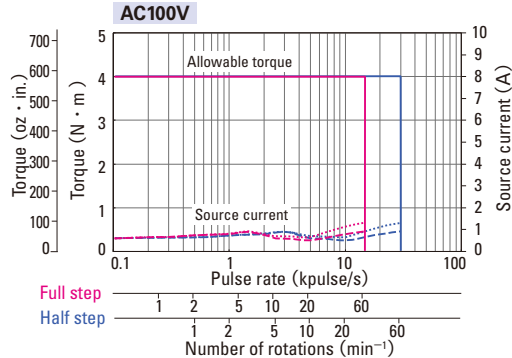

FSF781S-CX36
FSF781D-CX36

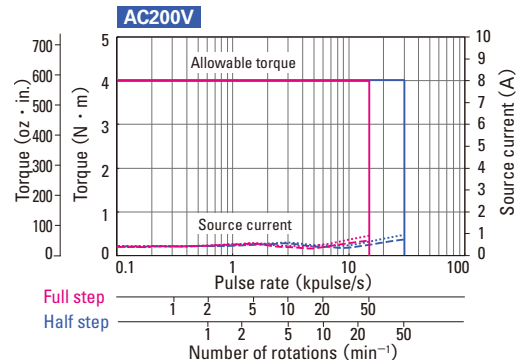
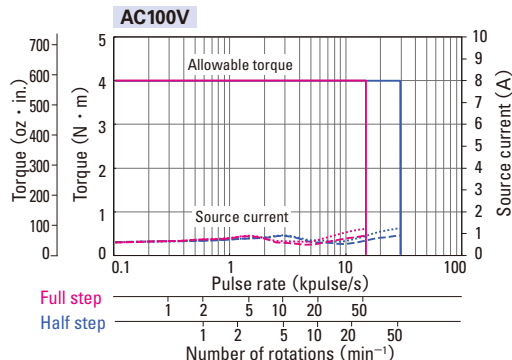

Motor size		φ86mm (φ3.39inch)			
Motor + gear length		127.3mm (5.01inch)	127.3mm (5.01inch)	127.3mm (5.01inch)	127.3mm (5.01inch)
Single shaft	Set ordering model no.	FSF851S-CX3.6	FSF851S-CX7.2	FSF851S-CX10	FSF851S-CX20
	Corresponding motor model number	103F8581-70CXA4	103F8581-70CXB4	103F8581-70CXE4	103F8581-70CXG4
Double shaft	Set ordering model no.	FSF851D-CX3.6	FSF851D-CX7.2	FSF851D-CX10	FSF851D-CX20
	Corresponding motor model number	103F8581-70CXA1	103F8581-70CXB1	103F8581-70CXE1	103F8581-70CXG1
Allowable torque	N · m (OZ · in.)	4.5 (637.2)	9 (1274.5)	9 (1274.5)	12 (1699.3)
Rotor inertia	× 10 ⁻⁴ kg · m ² (OZ · in. ²)	1.45 (7.93)	1.45 (7.93)	1.45 (7.93)	1.45 (7.93)
Basic step angle	DEG	0.2	0.1	0.072	0.036
Gear ratio	-	1 : 3.6	1 : 7.2	1 : 10	1 : 20
Backlash	DEG	0.35	0.22	0.22	0.15
Allowable speed	min ⁻¹	500	250	180	90
Motor mass ^(Note1)	kg (lbs)	2.7 (5.94)	2.7 (5.94)	2.7 (5.94)	2.7 (5.94)
Allowable thrust load	N (lbs)	60 (13.5)	60 (13.5)	60 (13.5)	60 (13.5)
Allowable radial load ^(Note2)	N (lbs)	300 (67.5)	300 (67.5)	300 (67.5)	300 (67.5)

The directions of motor rotation and gear output axle rotation are the same for models with reduction ratio 1:3.6 and 1:7.2 reduction ratios, and opposite for 1:10, 1:20, 1:30 and 1:36 reduction ratios.

(Note1) Driver mass ▶ P.29

(Note2) When load is applied at 1/3 length from output shaft edge.

Characteristics

Operating current : 0.75A/phase
Use the rubber coupling

Allowable torque Full step — Half step —
Source current (no load) Full step - - - Half step - - -

Source current (load applied) Full step ····· Half step ·····

FSF851S-CX3.6
FSF851D-CX3.6

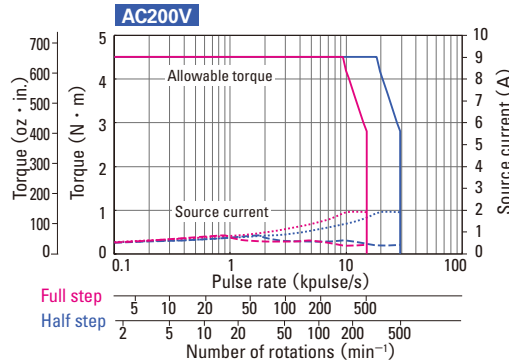
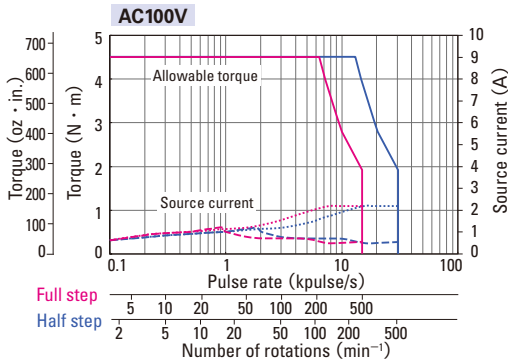

FSF851S-CX7.2
FSF851D-CX7.2

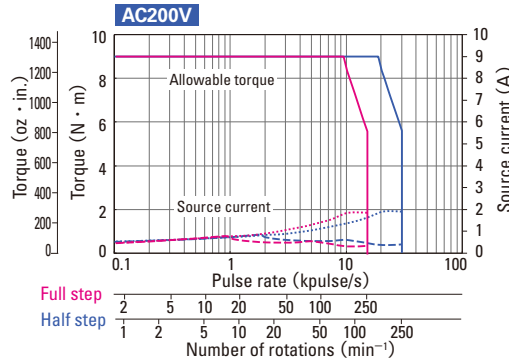
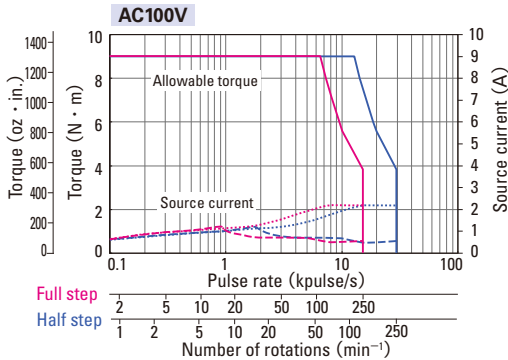

FSF851S-CX10
FSF851D-CX10

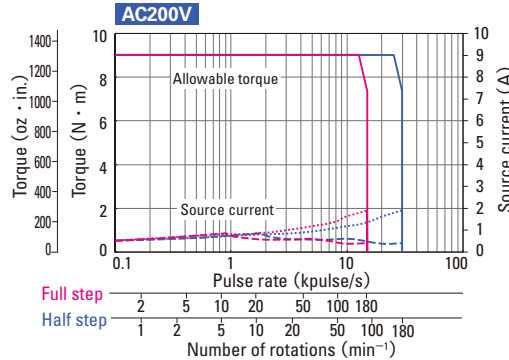
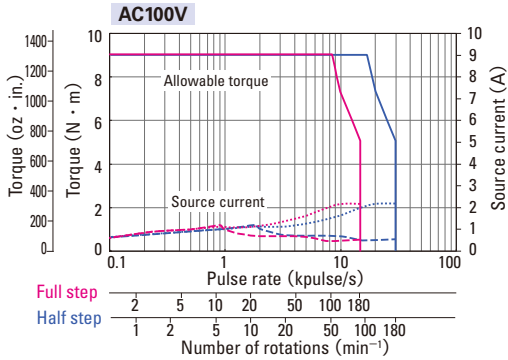

FSF851S-CX20
FSF851D-CX20

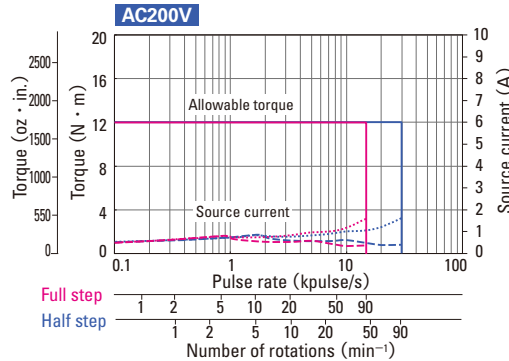
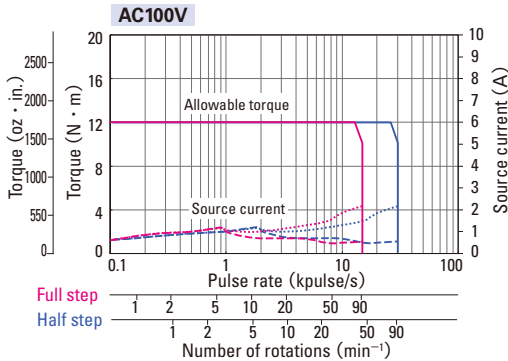

In motor+gear models, the gears may be damaged if allowable torque is exceeded. When selecting a motor, ensure that its allowable torque will not be exceeded. System configuration ▶ P.8 Set Model Configuration ▶ P.10 Motor dimensions ▶ P.101 Driver dimensions ▶ P.105 The data are measured under the drive condition of our company. The drive torque may very depending on the accuracy of customer-side equipment.

Low-backlash gear model

AC input Driver (Model number : FS1W075P00) + Motor with low-backlash gear

Rated current : 0.75A/phase

Motor size		φ86mm (φ3.39inch)	
Motor + gear length		127.3mm (5.01inch)	127.3mm (5.01inch)
Single shaft	Set ordering model no.	FSF851S-CX30	FSF851S-CX36
	Corresponding motor model number	103F8581-70CXJ4	103F8581-70CXK4
Double shaft	Set ordering model no.	FSF851D-CX30	FSF851D-CX36
	Corresponding motor model number	103F8581-70CXJ1	103F8581-70CXK1
Allowable torque	N · m (OZ · in)	12 (1699.3)	12 (1699.3)
Rotor inertia	$\times 10^{-4}$ kg · m ² (OZ · in ²)	1.45 (7.93)	1.45 (7.93)
Basic step angle	DEG	0.024	0.02
Gear ratio	-	1 : 30	1 : 36
Backlash	DEG	0.15	0.15
Allowable speed	min ⁻¹	60	50
Motor mass ^(Note1)	kg (lbs)	2.7 (5.94)	2.7 (5.94)
Allowable thrust load	N (lbs)	60 (13.5)	60 (13.5)
Allowable radial load ^(Note2)	N (lbs)	300 (67.5)	300 (67.5)

The directions of motor rotation and gear output axle rotation are the same for models with reduction ratio 1:3.6 and 1:7.2 reduction ratios, and opposite for 1:10, 1:20, 1:30 and 1:36 reduction ratios.

(Note1) Driver mass ▶ P.29

(Note2) When load is applied at 1/3 length from output shaft edge.

Characteristics

Operating current : 0.75A/phase
Use the rubber coupling

Allowable torque Full step — Half step —
Source current (no load) Full step - - - Half step - - -

Source current (load applied) Full step ····· Half step ·····

FSF851S-CX30
FSF851D-CX30

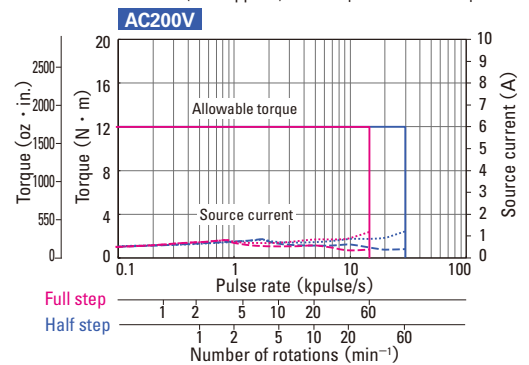
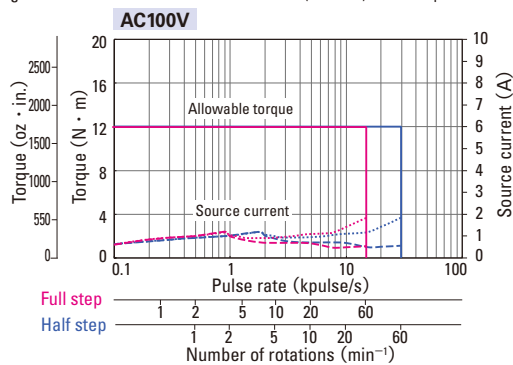

FSF851S-CX36
FSF851D-CX36

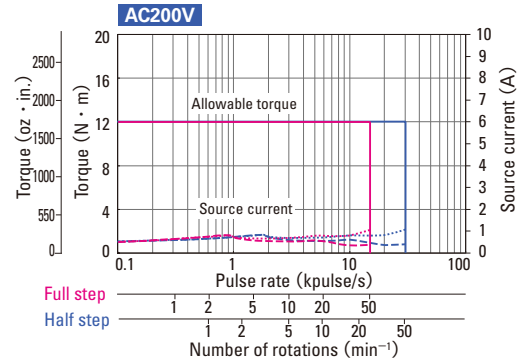
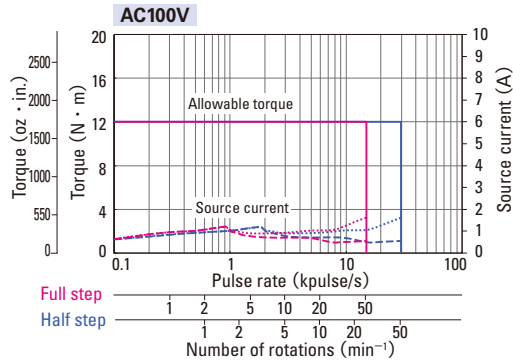

Harmonic gear model

AC input Driver (Model number : FS1W075P00) + Harmonic gear motor

Rated current : 0.75A/phase

Motor size		42mm sq. (1.65inch sq.)			60mm sq. (2.36inch sq.)
Motor + gear length		73.5 mm (2.89inch)	73.5 mm (2.89inch)	73.5 mm (2.89inch)	113.5mm (4.47inch)
Single shaft	Set ordering model no.	FSF551S-HX30	FSF551S-HX50	FSF551S-HX100	FSF781S-HX50
	Corresponding motor model number	103F5505-70HXJ5	103F5505-70HXL5	103F5505-70HXM5	103F7851-70HXL4
Double shaft	Set ordering model no.	FSF551D-HX30	FSF551D-HX50	FSF551D-HX100	FSF781D-HX50
	Corresponding motor model number	103F5505-70HXJ2	103F5505-70HXL2	103F5505-70HXM2	103F7851-70HXL1
Allowable torque	N · m (OZ · in)	2.2 (311.5)	3.5 (495.6)	5 (708.1)	5.5 (778.8)
Momentary allowable torque	N · m (OZ · in)	4.5 (637.3)	8.3 (1175.4)	11 (1557.7)	14 (1982.6)
Rotor inertia	$\times 10^{-4}$ kg · m ² (OZ · in ²)	0.042 (0.23)	0.042 (0.23)	0.042 (0.23)	0.31 (1.695)
Basic step angle	DEG	0.024	0.0144	0.0072	0.0144
Gear ratio	-	1:30	1:50	1:100	1:50
Hysteresis loss	Minute	3.6	2.4	2.4	-
Lost motion	Minute	-	-	-	0.4 to 3 ± 0.28N · m (3.965oz · in)
Allowable speed	min ⁻¹	116	70	35	70
Motor mass ^(Note1)	kg (lbs)	0.43 (0.94)	0.43 (0.94)	0.43 (0.94)	1.2 (2.64)
Allowable thrust load	N (lbs)	1150 (258.75)	1150 (258.75)	1150 (258.75)	400 (90)
Allowable radial load ^(Note2)	N (lbs)	275 (61.88)	275 (61.88)	275 (61.88)	360 (81)

Note: The gear output shaft rotates in the opposite direction.

(Note1) Driver mass ▶ P.29

(Note2) When load is applied at 1/3 length from output shaft edge.

Characteristics

Operating current : 0.75A/phase
Use the rubber coupling

Momentary allowable torque
Source current (load applied)

Full step --- Half step ---
Full step --- Half step ---

Allowable torque
Source current (no load)

Full step --- Half step ---
Full step --- Half step ---

FSF551S-HX30
FSF551D-HX30

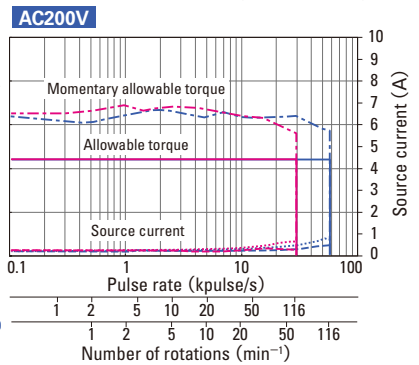
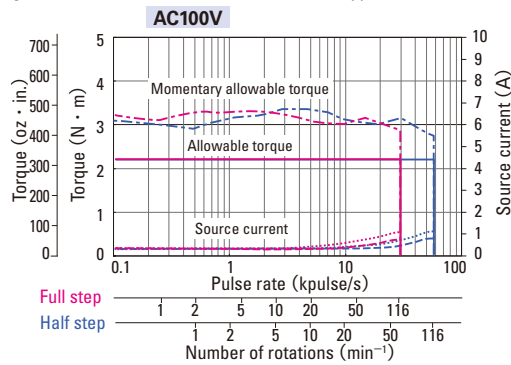

FSF551S-HX50
FSF551D-HX50

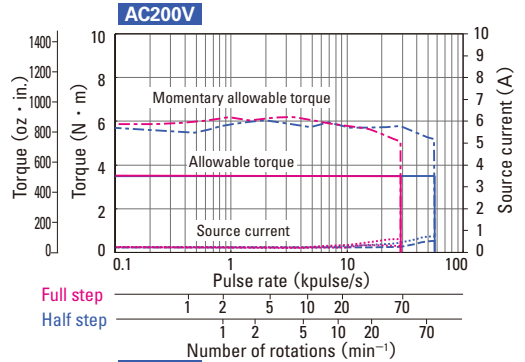
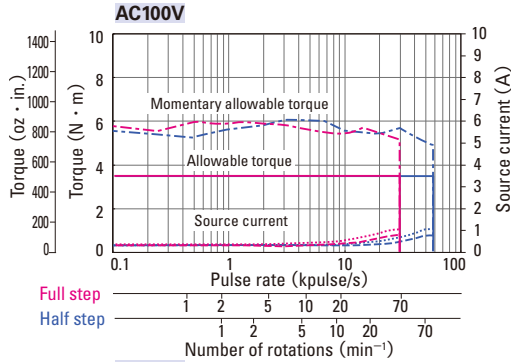

FSF551S-HX100
FSF551D-HX100

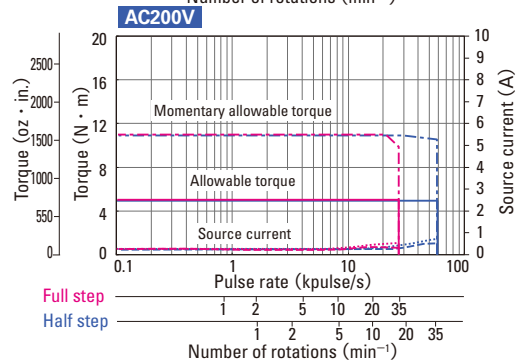
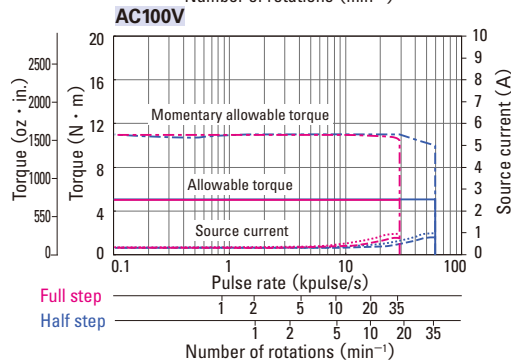

FSF781S-HX50
FSF781D-HX50

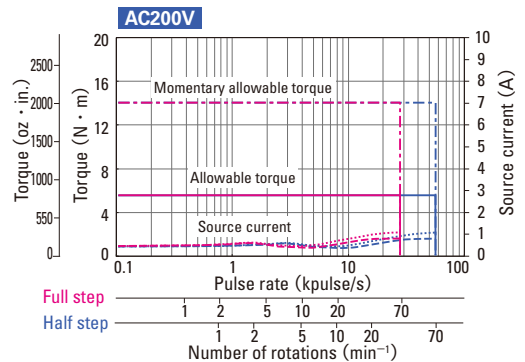
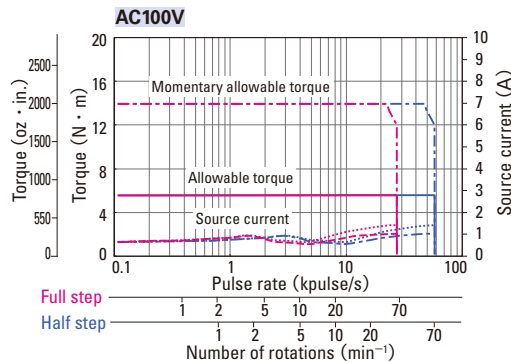

In motor+gear models, the gears may be damaged if allowable torque is exceeded. When selecting a motor, ensure that its momentary allowable torque will not be exceeded. System configuration ▶ P.8 Set Model Configuration ▶ P.10 Motor dimensions ▶ P.102 to 103 Driver dimensions ▶ P.105 The data are measured under the drive condition of our company. The drive torque may vary depending on the accuracy of customer-side equipment.

Harmonic gear model AC input Driver (Model number : FS1W075P00) + Harmonic gear motor

Rated current : 0.75A/phase

Motor size		60mm sq. (2.36inch sq.)	φ86mm (φ3.39inch)	
Motor + gear length		113.5mm (4.47inch)	144.15mm (5.68inch)	144.15mm (5.68inch)
Single shaft	Set ordering model no.	FSF781S-HX100	FSF851S-HX50	FSF851S-HX100
	Corresponding motor model number	103F7851-70HXM4	103F8581-70HXL4	103F8581-70HXM4
Double shaft	Set ordering model no.	FSF781D-HX100	FSF851D-HX50	FSF851D-HX100
	Corresponding motor model number	103F7851-70HXM1	103F8581-70HXL1	103F8581-70HXM1
Allowable torque	N · m (OZ · in)	8 (1132.9)	25 (3540.2)	40 (5664.3)
Momentary allowable torque	N · m (OZ · in)	20 (2832.2)	34 (4814.8)	59 (8355.1)
Rotor inertia	× 10 ⁻⁴ kg · m ² (OZ · in ²)	0.31 (1.695)	1.65 (9.021)	1.65 (9.021)
Basic step angle	DEG	0.0072	0.0144	0.0072
Gear ratio	-	1 : 100	1 : 50	1 : 100
Hysteresis loss	Minute	-	-	-
Lost motion	Minute	0.4 to 1.5 ± 0.4N · m (56.645oz · in)	0.4 to 3 ± 1N · m (141.612oz · in)	0.4 to 3 ± 1.2N · m (169.934oz · in)
Allowable speed	min ⁻¹	35	70	35
Motor mass ^(Note1)	kg (lbs)	1.2 (2.64)	3.3 (7.26)	3.3 (7.26)
Allowable thrust load	N (lbs)	400 (90)	1400 (315)	1400 (315)
Allowable radial load ^(Note2)	N (lbs)	360 (81)	1380 (310.5)	1380 (310.5)

Note: The gear output shaft rotates in the opposite direction.

(Note1) Driver mass ▶ P.29

(Note2) When load is applied at 1/3 length from output shaft edge.

Characteristics

Operating current : 0.75A/phase
Use the rubber coupling

Momentary allowable torque
Source current (load applied)

Full step --- Half step ---
Full step --- Half step ---

Allowable torque
Source current (no load)

Full step --- Half step ---
Full step --- Half step ---

FSF781S-HX100
FSF781D-HX100

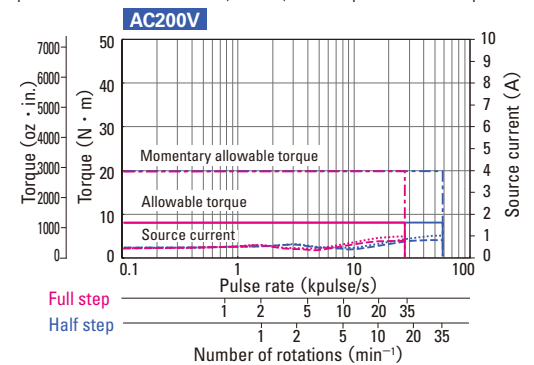
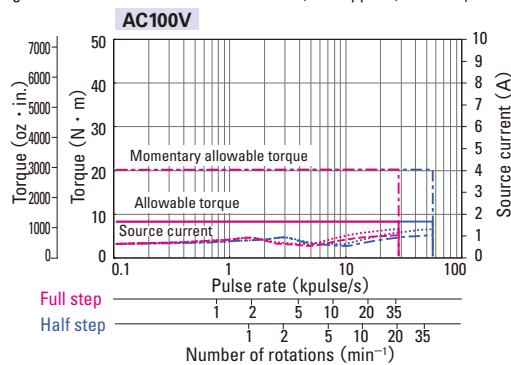

FSF851S-HX50
FSF851D-HX50

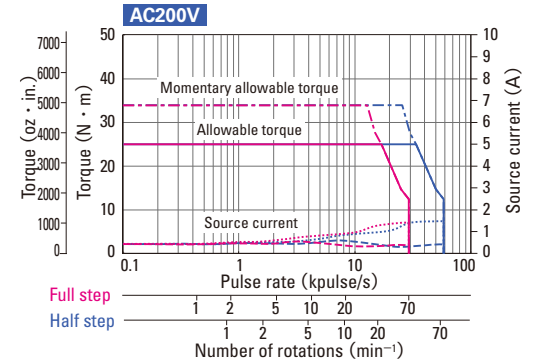
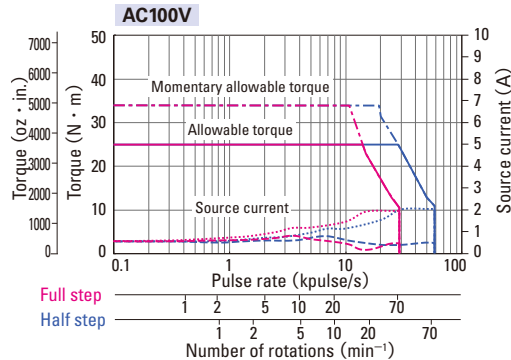

FSF851S-HX100
FSF851D-HX100

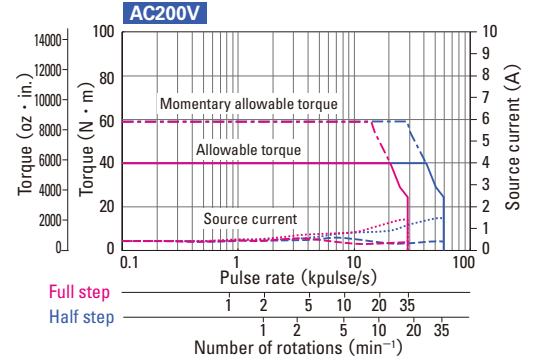
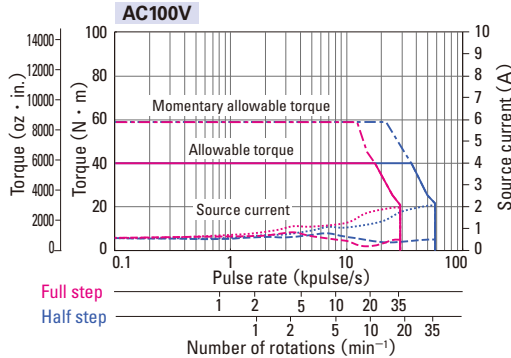

Electromagnetic brake model

AC input Driver (Model number : FS1W075P00) + Electromagnetic brake motor

Basic step angle : 0.72° Rated current : 0.75A/phase

Motor size		42mm sq. (1.65 inch sq.)			60mm sq. (2.36inch sq.)
Motor + brake length		64.5mm (2.54inch)	70.5mm (2.78inch)	79.5mm (3.13inch)	85.8mm (3.38inch)
Set ordering model no.		FSF551S-XB	FSF552S-XB	FSF554S-XB	FSF781S-XB
Corresponding motor model number		103F5505-70XB41	103F5508-70XB41	103F5510-70XB41	103F7851-70XB41
Holding torque	N · m (OZ · in)	0.13 (8.4)	0.18 (25.49)	0.26 (36.82)	0.6 (85.0)
Rotor inertia	$\times 10^{-4}$ kg · m ² (OZ · in ²)	0.045 (0.246)	0.068 (0.372)	0.08 (0.437)	0.43 (2.351)
Motor mass ^(Note1)	kg (lbs)	0.38 (0.84)	0.43 (0.95)	0.52 (1.14)	0.94 (2.07)
Allowable thrust load	N (lbs)	10 (2.25)	10 (2.25)	10 (2.25)	20 (4.5)
Allowable radial load ^(Note2)	N (lbs)	35 (8.75)	35 (8.75)	35 (8.75)	80 (18)
Brake type		No excitation actuating type	No excitation actuating type	No excitation actuating type	No excitation actuating type
Electromagnetic brake	Power supply input	DC24V ± 5%			DC24V ± 5%
	Excitation current	0.08			0.25
	Power consumption	2			6
	Static friction torque	0.3 (42.48)			0.8 (113.29)
	Brake operating time	20			20
	Brake release time	30			30

(Note1) Driver mass ▶ P.29

(Note2) When load is applied at 1/3 length from output shaft edge.

Characteristics

Operating current : 0.75A/phase
Use the rubber coupling

Pull-out torque Source current (no load) Full step Half step fs : Maximum self-start frequency when not loaded Full step Half step Source current (load applied) Full step Half step

FSF551S-XB

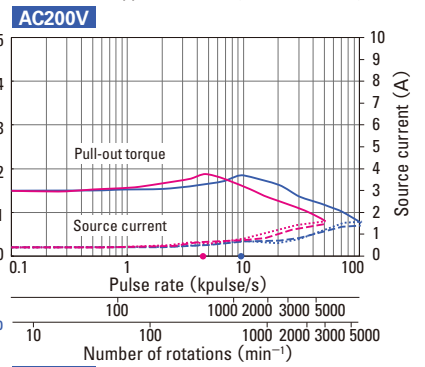
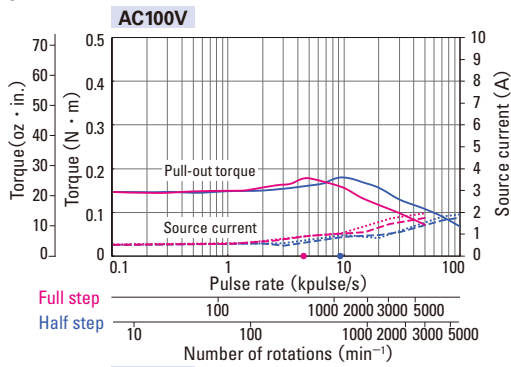

FSF552S-XB

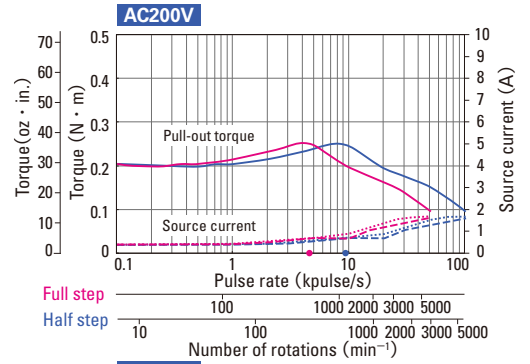
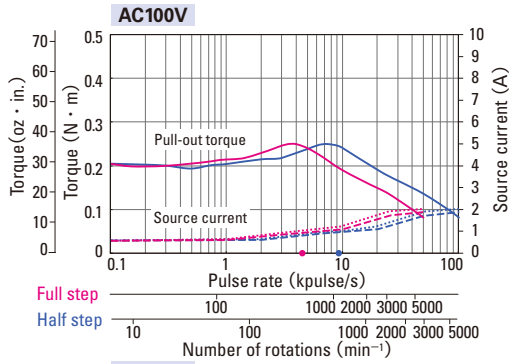

FSF554S-XB

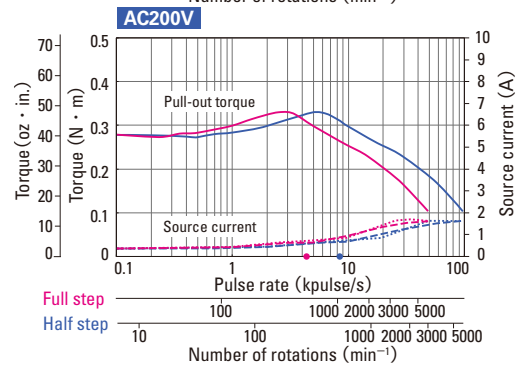
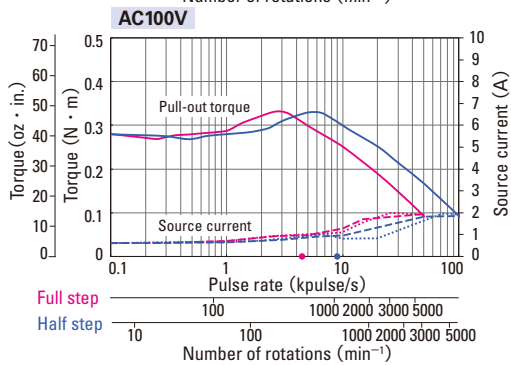

FSF781S-XB

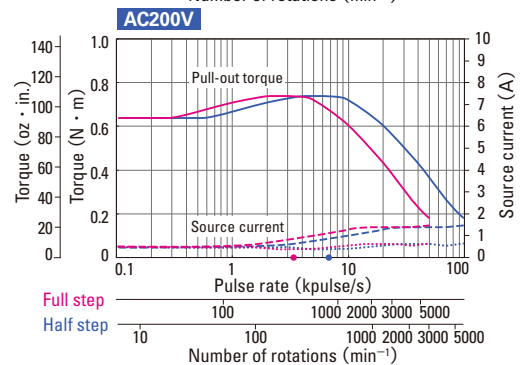
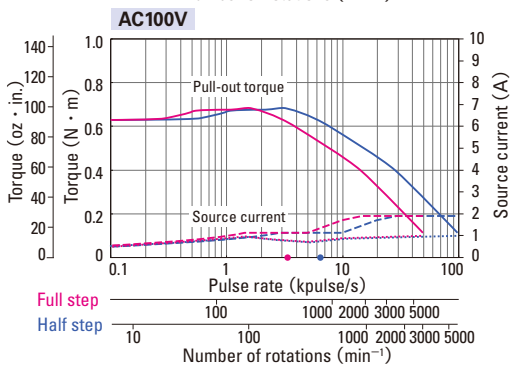

The electromagnetic brake only works when the motor is stopped, and cannot be used for braking. System configuration ▶ P.8 Set Model Configuration ▶ P.10 Motor dimensions ▶ P.104

Driver dimensions ▶ P.105 The data are measured under the drive condition of our company. The drive torque may very depending on the accuracy of customer-side equipment.

Electromagnetic brake model

AC input Driver (Model number : FS1W075P00) + Electromagnetic brake motor

Basic step angle : 0.72° Rated current : 0.75A/phase

Motor size		60mm sq. (2.36inch sq.)		φ86mm (φ3.39inch)	
		94.5mm (3.72inch)	126.7mm (4.99inch)	116.7mm (4.59inch)	146.8mm (5.78inch)
Motor + brake length					
Set ordering model no.		FSF782S-XB		FSF783S-XB	
Corresponding motor model number		103F7852-70XB41		103F7853-70XB41	
Holding torque	N · m (OZ · in)	0.93 (131.7)		1.79 (253.5)	
Rotor inertia	$\times 10^{-4}$ kg · m ² (OZ · in ²)	0.56 (3.062)		1 (5.468)	
Motor mass ^(Note1)	kg (lbs)	1.12 (2.46)		1.7 (3.74)	
Allowable thrust load	N (lbs)	20 (4.5)		20 (4.5)	
Allowable radial load ^(Note2)	N (lbs)	80 (18)		80 (18)	
Brake type		No excitation actuating type		No excitation actuating type	
Electromagnetic brake	Power supply input	DC24V ± 5%		DC24V ± 5%	
	Excitation current	0.25		0.25	
	Power consumption	6		6	
	Static friction torque	0.8 (113.29)		0.8 (113.29)	
	Brake operating time	20		20	
	Brake release time	30		30	
		No excitation actuating type		No excitation actuating type	
		DC24V ± 5%		DC24V ± 5%	
		0.42		0.42	
		10		10	
		5 (708)		5 (708)	
		20		20	
		30		50	

(Note1) Driver mass ▶ P.29

(Note2) When load is applied at 1/3 length from output shaft edge.

Characteristics

Operating current : 0.75A/phase
Use the rubber coupling

Pull-out torque Full step — Half step — fs : Maximum self-start frequency when not loaded Full step ● Half step ●
Source current (no load) Full step - - - Half step - - - Source current (load applied) Full step Half step

FSF782S-XB

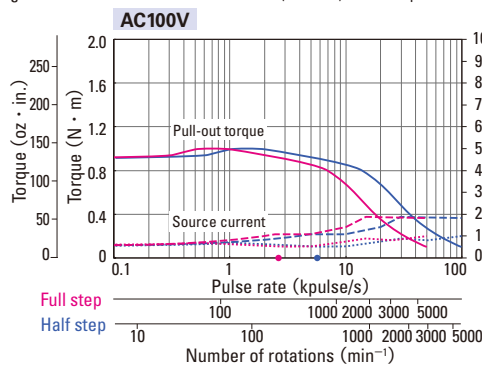

AC200V

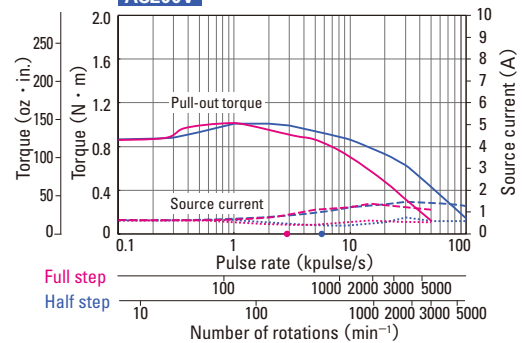

FSF783S-XB

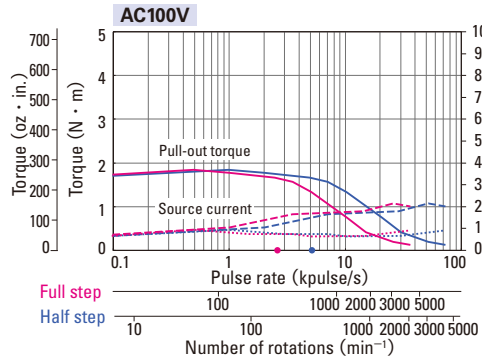

AC200V

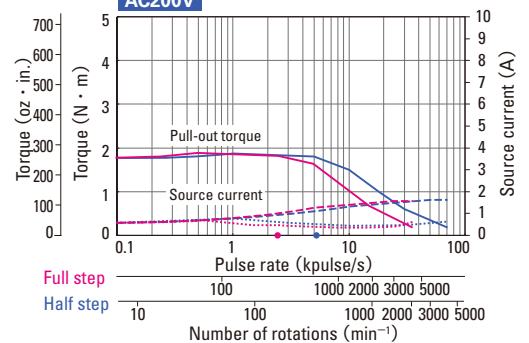

FSF851S-XB

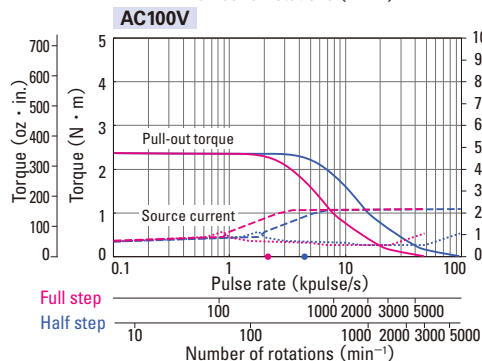

AC200V

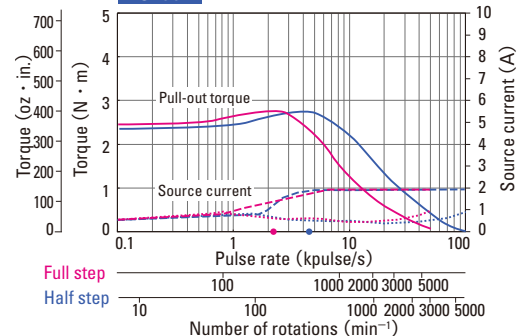

FSF852S-XB

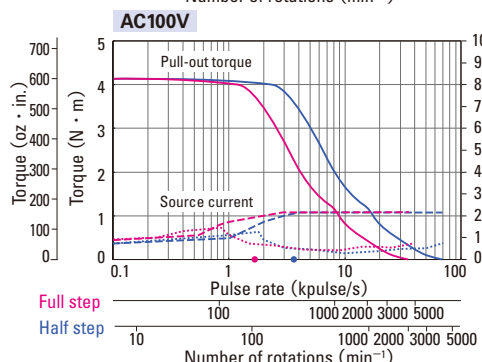

AC200V

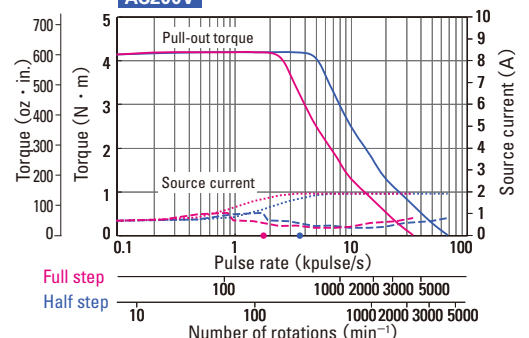

Motor size	φ 86mm (φ 3.39inch)	
Motor + brake length	180.4mm (7.10inch)	
Set ordering model no.	FSF853S-XB	
Corresponding motor model number	103F8583-70XB41	
Holding torque	N · m (OZ · in)	6.17 (873.7)
Rotor inertia	$\times 10^{-4}$ kg · m ² (OZ · in ²)	5.19 (28.376)
Motor mass ^(Note1)	kg (lbs)	5.5 (12.1)
Allowable thrust load	N (lbs)	60 (13.5)
Allowable radial load ^(Note2)	N (lbs)	220 (49.5)
Brake type	No excitation actuating type	
Electromagnetic brake	Power supply input	V
	Excitation current	A
	Power consumption	W
	Static friction torque	N · m (OZ · in)
	Brake operating time	ms
	Brake release time	ms

(Note1) Driver mass ▶ P.29

(Note2) When load is applied at 1/3 length from output shaft edge.

Characteristics

Operating current : 0.75A/phase
Use the rubber coupling

Pull-out torque Full step
Source current (no load) Full step

Half step
Half step

fs : Maximum self-start frequency when not loaded Full step

Half step
Source current (load applied) Full step
Half step

FSF853S-XB

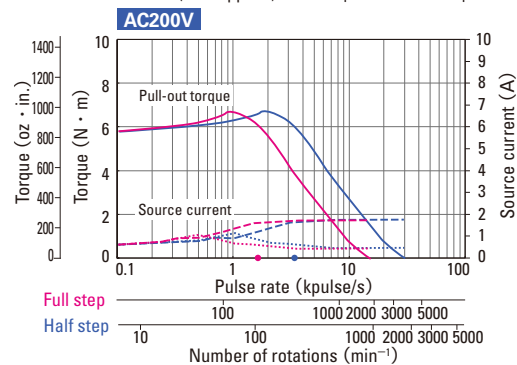
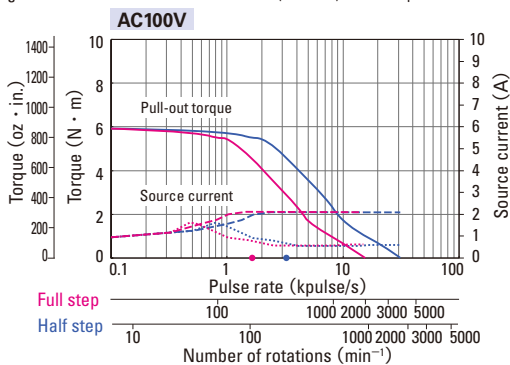

Motor specifications

General specifications

Model number	103F55 □□	103F785 □/□ 103F858 □	103F8958 □	103M55 ○○/○ 103M858 ○	103M785 ○/○	103M8958 ○
Specification type	—			S1 (continuous operation)		
Ambient operation temperature	- 10 to + 50°C (0 to + 40°C for harmonic gear model)			- 10 to + 40°C		
Storage temperature	- 20 to + 65°C			- 20 to + 60°C		
Ambient operation humidity	20 to 90% RH (no condensation)			95% RH Max.: Under 40°C, 57% RH Max.: Under 50°C, 35% RH Max.: Under 60°C (no condensation)		
Storage humidity	5 to 95% RH (no condensation)					
Operation altitude	1000 m (3280 feet) MAX. above sea level			1000 m (3280 feet) MAX. above sea level		
Vibration resistance	Vibration frequency 10 to 500 Hz, total amplitude 1.52 mm (10 to 70 Hz), vibration acceleration 147 m/s ² (70 to 500 Hz), sweep time 15 min/cycle, 12 sweeps in each X, Y and Z direction.					
Impact resistance	490m/s ² of acceleration for 11 ms with half-sine wave applying three times for X, Y, and Z axes each, 18 times in total.					
Insulation class	Class B (+ 130°C)			Class B (+ 130°C) [UL class A (+ 105°C)]		
Withstand voltage	At normal ambient temperature and humidity, no failure with 1500 V AC @50/60 Hz applied for one minute between motor winding and frame.					
Insulation resistance	At normal ambient temperature and humidity, 100 Mohm or more on megger with 500 V DC between motor winding and frame.					
Protection grade	IP40					
Wiring temperature increase	80K MAX. (Based on Sanyo Denki standard)			80K MAX. (Based on Sanyo Denki standard)		
Axial play ^(Note1)	0.075mm (0.002952inch) MAX., Load 4.4N (1lbs)	0.075mm (0.002952inch) MAX., Load 9N (2lbs)	0.075mm (0.002952inch) MAX., Load 9N (2lbs)	0.075mm (0.002952inch) MAX., Load 9N (2lbs)		0.075mm (0.002952inch) MAX., Load 9N (2lbs)
Radial play ^(Note2)	0.025mm (0.00098inch) MAX., Load 4.4N (1lbs)			0.025mm (0.00098inch)MAX., Load 4.4N (1lbs)		0.025mm (0.00098inch) MAX., Load 4.4N (1lbs)
Shaft runout	0.025mm	0.025mm	0.05mm	0.025mm		0.05mm
Inserted part concentricity against shaft	φ 0.05mm	φ 0.075mm	φ 0.075mm	φ 0.075mm		φ 0.075mm
Fitted surface angularity against shaft	0.1mm	0.1mm	0.1mm	0.1mm		0.1mm

(Note1) Axial play: Shaft displacement under axial load.

(Note2) Radial play: Shaft displacement under radial load applied 1/3rd of the length from the end of the shaft.

Safety standards

Type code : 103M55 ○○ / 103M785 ○ / 103M858 ○ / 103M8958 ○ (CE / UL model)

CE	Directives	Standard part	
	Low-voltage directives	EN-60034-1, IEC34-5, (EN-60034-5)	
UL	Acquired standards	Standard part	File No.
	UL	UL1004, UL2111	E208878
	UL for Canada (c-UL)		

Internal wire connection

Connection Method: Pentagon

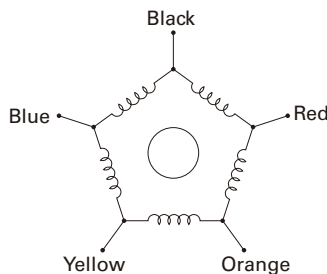

Direction of motor rotate

The direction of motor rotate is counterclockwise when viewed from the output shaft side at the direct current energization in the following order.

This is an instance of the standard model, the electromagnetic brake model and the CE / UL model.

As for some of the models with the gear, the direction of motor rotation is different, please make inquiries.

		Exciting order									
		1	2	3	4	5	6	7	8	9	10
Color of leads	Black	-	-	-	-	-	+	+	+	+	-
	Red	-	+	+	+	+	-	-	-	-	-
	Orange	+	-	-	-	-	-	+	+	+	-
	Yellow	-	-	+	+	+	+	+	-	-	-
	Blue	+	+	+	-	-	-	-	-	-	+

Driver specifications

General specifications

Basic specifications	Model number	FS1W075P00	
	Power supply	Single phase AC100V to 230V + 10, - 15%, 50/60Hz	
	Source current	4A Max.	
	Environment	Protection class	Class I
		Operation environment	Installation category (over-voltage category) : II (CE), Pollution level : 2
		Ambient operation temperature	0 to + 50°C
		Storage temperature	- 20 to + 70°C
		Ambient operation humidity	35 to 85%RH (no condensation)
		Storage humidity	10 to 90%RH (no condensation)
		Operation altitude	1000 m (3280 feet) MAX. above sea level
		Vibration resistance	Tested under the following conditions ; 5m/s ² , frequency range 10 to 55Hz, direction along X, Y and Z axes, for 2 hours each
Impact resistance		Not influenced at NDS-C-0110 standard section 3.2.2 division "C".	
Withstand voltage		Not influenced when 1500V AC is applied between power input terminal and cabinet for one minute.	
Insulation resistance	10M ohm MIN. when measured with 500V DC megohmmeter between input terminal and cabinet.		
Mass	0.8kg		
Functions	Protection functions	Driver overheating, main circuit power supply error, and over-current	
	LED indication	Electric power monitor, phase origin monitor, pulse monitor, alarm indications (overcurrent, overheating protection, supply under- and overvoltage, hardware fault, motor disconnection or non-standard motor connection)	
Signal	Input signal	Photo-coupler input system ; input resistance: 220 Ω ; input-signal "H" level : 4.0 to 5.5V ; input-signal "L" level : 0 to 0.5V	
	Output signal	From the photo coupler by the open collector output Output specification : Vceo = 30V MAX., Ic = 5mA	

Safety standards

	Directives	Category	Standard part	Name
CE (TÜV)	Low-voltage directives	-	EN50178	-
	EMC directives	Emission	EN55011-A	Terminal disturbance voltage
			EN55011-A	Electromagnetic radiation disturbance
		Immunity	EN61000-4-2	ESD (Electrostatic discharge)
			EN61000-4-3	RS (Radio-frequency amplitude modulated electromagnetic field)
			EN61000-4-4	Fast transients
			EN61000-4-6	Surges
			EN61000-4-5	CS (Radio-frequency common mode)
			EN61000-4-11	Voltage dips, Voltage interruptions
UL	Acquired standards		Standard part	File No.
	UL		UL508C	E179775
	UL for Canada (c-UL)			

- EMC characteristics may vary depending on the configuration of the users' control panel, which contains the driver or stepping motor, or the arrangement and wiring of other electrical devices.
- Validation test of driver has been performed for low-voltage EMC directives at TÜV (TÜV SUD Japan) for self-declaration of CE marking.

AC input Set model
Micro step

DC input Set model
Micro step

DC input Set model
Full / half step

Stepping Motor

Linear Actuator
Stepping Motor

Stepping motor for
vacuum environment

Dimensions

Driver Controls and Connectors

2-digit LED indication

	Indication	Description
Status	88	Internal power is established.
	88	Excitation phase is origin status at power on.
	88	Command pulse is under status at input.
Alarm	01	Over-current
	02	Overheat
	03	Low voltage power
	04	Over-voltage power
	05-08	Hardware fault
	06	Motor is not connected or motor that is not in compliance with standards is connected.



Motor interface connector

Power connector

Earth

Display switch Alarm history of 10 previous alarms can be displayed on 2-digit LED.

- 1 Step angle selection switch
- 2 Current selection switch
- 3 0-speed current adjustment switch
- 4 Function selection DIP switch

5 Input/output signal interface connector

1 Step angle selection switch (S.S)

Basic step angle divisor (up to 250 divisions).

Indication	0	1	2	3	4	5	6	7
Number of divisions	1	2	2.5	4	5	8	10	20
Indication	8	9	A	B	C	D	E	F
Number of divisions	25	40	50	80	100	125	200	250

Initial configuration of factory shipment is set to 1 (Half steps).

2 Operation current selection switch (RUN)

Motor current during operation can be selected from 100 to 25%.

Indication	0	1	2	3	4	5	6	7
Motor current (%)	100	95	90	85	80	75	70	65
	(Rated value)							
Indication	8	9	A	B	C	D	E	F
Motor current (%)	60	55	50	45	40	35	30	25

Initial configuration of factory shipment is set to 0 (rated value).

3 Current adjustment at operation halt switch (STP)

Motor current at 0-speed can be selected from 100 to 25%.

Indication	0	1	2	3	4	5	6	7
Motor current (%)	100	95	90	85	80	75	70	65
	(Rated value)							
Indication	8	9	A	B	C	D	E	F
Motor current (%)	60	55	50	45	40	35	30	25

Initial configuration of factory shipment is set to A (50% of rated value).
Driver and motor should be operated at around 50% of rated value to reduce heat.

5 Input/output signal interface connector

This connector is for host system connection.
The driver-side connector is 10214-52A2JL (Sumitomo 3M).

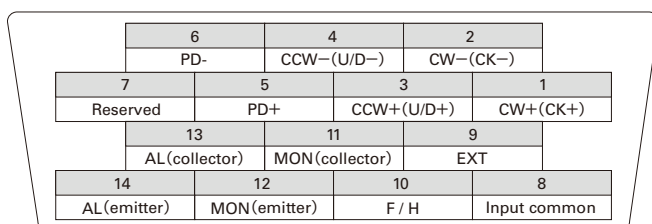

Terminal arrangement of CN3 connector

4 Function selection DIP switch

Selects an appropriate function for specification.

Factory default settings

	OFF	ON	
F/R	<input type="checkbox"/>	<input type="checkbox"/>	OFF Input method select
LV	<input type="checkbox"/>	<input type="checkbox"/>	OFF Low-vibration mode select
PD	<input type="checkbox"/>	<input type="checkbox"/>	OFF Power down select
EORG	<input type="checkbox"/>	<input type="checkbox"/>	OFF Excitation select

Input method select (F/R)

Selects input pulse type.

F/R	Input pulse type
ON	1 input (CK,U/D)
OFF	2 input (CW,CCW)

Low-vibration mode select (LV)

Low-vibration and smooth drive even with coarse resolution of one or two divisions (full-/half-step) settings.

LV	Operation
ON	Auto-micro function
OFF	Micro-step

Power down select (PD)

Selects current for power down signal input.

PD	Motor current
ON	Current by rotary switch STP (power low)
OFF	0A (power off)

Excitation select (EORG)

The excitation phase when the power supply is turned on is selected.

EORG	Original excitation phase
ON	Excitation phase at power shut off
OFF	Phase origin

By turning on the EORG, excitation phase when power OFF will be saved.
Therefore, there will be no shaft displacement when turning the power ON.

Connections and Signals

External wiring diagram

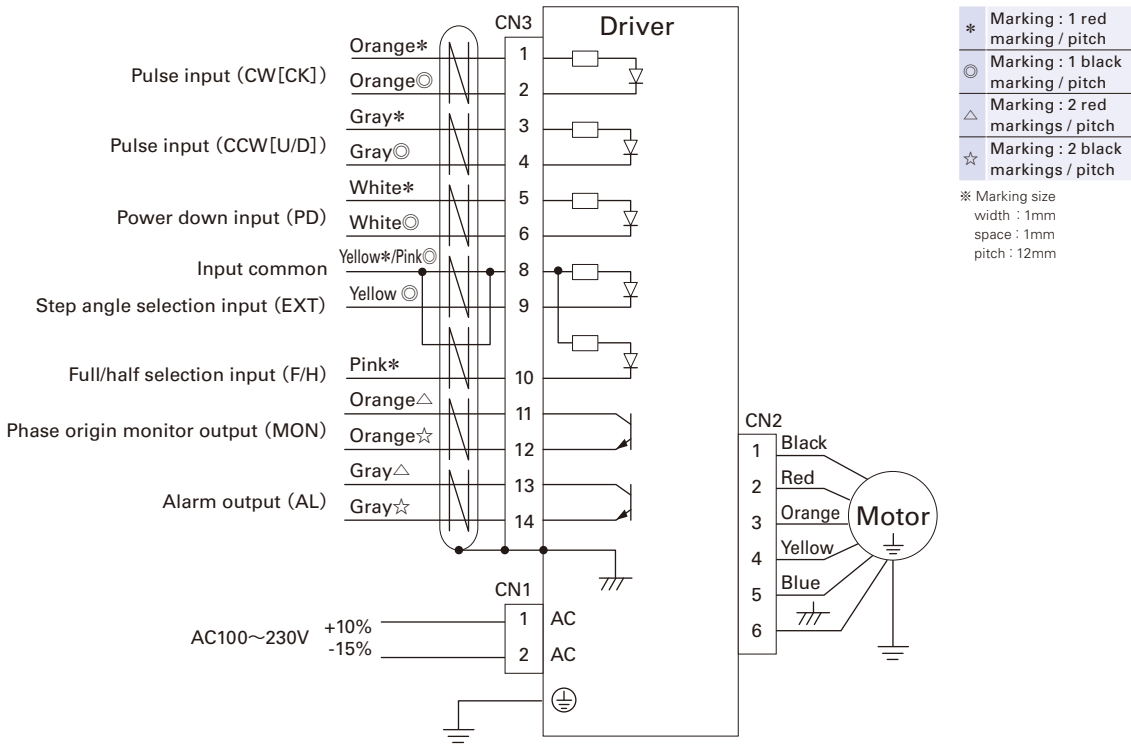

Applicable wire sizes

Motor size	42mm sq. (1.65inch sq.)	60mm sq. (2.36inch sq.)	φ86mm (φ3.39inch)	φ106mm (φ4.17inch)
Power supply	AWG18 (0.75mm ²) Min.			
Input/output signal	AWG24 (0.2mm ²) to 30 (0.05mm ²) (twisted pairs in bundle shield)			
Motor	AWG26 (0.15mm ²) Min.	AWG22 (0.3mm ²) Min.	AWG22 (0.3mm ²) Min.	AWG18 (0.75mm ²) Min.
Earth	AWG18 (0.75mm ²) Min.			

Specification summary of CN3 I/O signal

Signal name	CN3 Pin number	Function
CW pulse input (standard)	1	When using "2-input mode"
	2	Drive pulse for the CW direction rotation is input.
Pulse column input	1	When using "Pulse and direction mode"
	2	Drive pulse train for the stepping motor rotation is input.
CCW pulse input (standard)	3	When using "2-input mode"
	4	Drive pulse for the CCW direction rotation is input.
Rotation direction input	3	The rotation direction signal of stepping motor is input for the "Pulse and direction mode". Internal photocoupler ON ... CW direction
	4	Internal photocoupler OFF ... CCW direction
Power down input	5	Inputting the PD signal cuts OFF the current flowing through the stepping motor (turns OFF the power). (The power down input can be changed to the power low function by selecting dipswitches.)
	6	PD input signal ON (internal photocoupler ON) ... PD function enabled PD input signal OFF (internal photocoupler OFF) ... PD function disabled
Step-angle selection input	8	Apply EXT signal to enable full-/half-step selection (input).
	9	EXT input signal ON (internal photocoupler ON) ... full/half external input signal enabled. EXT input signal OFF (internal photocoupler OFF) ... rotary switch SS enabled.
FULL/HALF selection input	8	When the EXT input signal is ON (internal photocoupler ON).
	10	F/H input signal ON (internal photocoupler ON) ... HALF step F/H input signal OFF (internal photocoupler OFF) ... FULL step
Phase origin monitor output	11	It is turned ON when the excitation phase is at the origin (in the state when the power is turned ON)
	12	It is turned ON once per 10 pulses when setting to HALF step. It is turned ON once per 20 pulses when setting to FULL step.
	13	When an alarm circuit in the driver is tripped, an external signal is output (photocoupler ON).
Alarm output	14	At this time, the stepping motor is de-energized.

(Note) The CW rotation direction of stepping motor means the clockwise direction rotation as viewed from the output shaft side (ange side).
The CCW rotation direction means the counterclockwise direction rotation as viewed from the output shaft side (ange side).

Input circuit configuration of CW (CK), CCW (U/D)

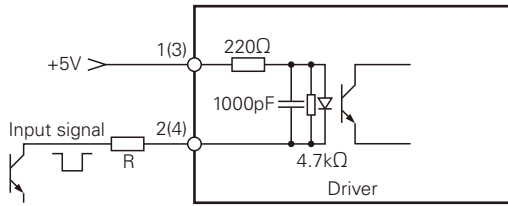

- Pulse duty 50% MAX.
- Maximum input frequency: 250kpulse/s
- When the crest value of the input signal exceeds 5V,
- use the external limit resistance R to limit the input current to approximately 15mA.

Input signal specification

<Photo coupler>

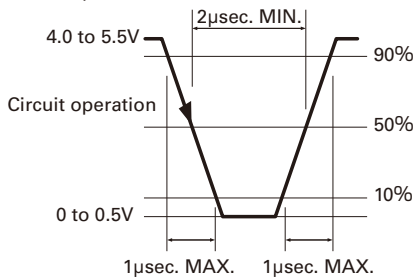

Timing of command pulse

2 input type (CW,CCW)

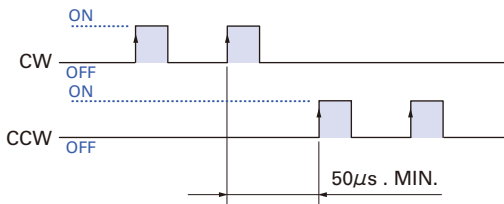

- The shaded regions in the diagram indicate when the internal photocoupler is ON. The internal circuit (motor) is active at the rising edge of the photocoupler pulses.
- To apply pulse to CW, set CCW side internal photo coupler to "OFF".
- To apply pulse to CCW, set CW side internal photo coupler to "OFF".

1 input type (CK, U/D)

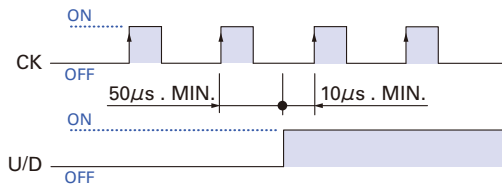

- The shaded regions in the diagram indicate when the internal photocoupler is ON. The internal circuit (motor) is active at the rising edge of the CK-side photocoupler pulses.
- Switching of U/D input signal must be done while CK side internal photo coupler is "OFF".

Input circuit configuration of PD, EXT, F/H

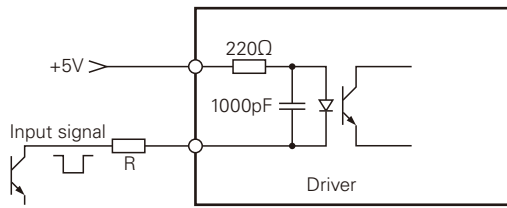

- If the peak value exceeds 5V, set the input current to approx. 15mA using the external limit resistance R.

Output signal configuration of MON, AL

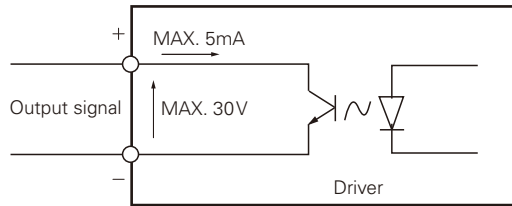

MON output

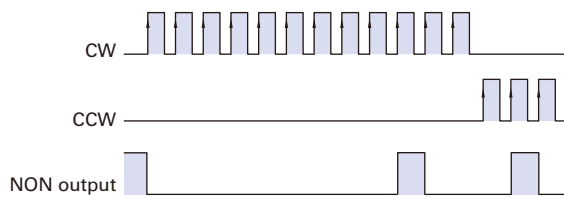

Ex.) Setting when number of division is 1 (full step)

- Photo coupler at phase origin of motor excitation (status at power on) is set to "ON".
- Output from MON is set to on at every 7.2 degrees of motor output shaft from phase origin.

DC input Set model

Micro step

Set Model Configuration ▶ P.36
 Specifications · Characteristics ▶ P.38 to 52
 Motor specifications ▶ P.53 Driver specifications ▶ P.54
 Motor dimensions ▶ P.97 to 104 Driver dimensions ▶ P.105

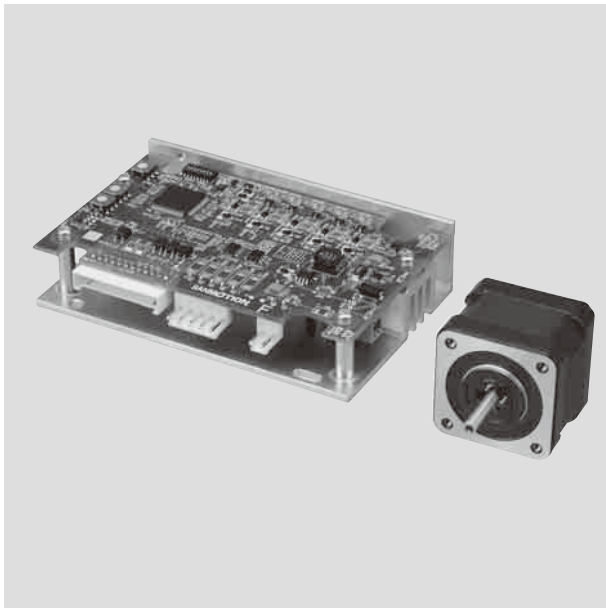

Features

- The auto-micro function provides low vibration and smooth drive even with coarse resolution setting of one or two divisions (full-/half-step), and supports micro steps of 250 divisions.
- High precision current detection reduces speed fluctuations by 50% compared with former model.※

※ Model No.: F5PAE140P100. Our conventional product Model No.: PMDPC1S3P01

Set model configuration items

Driver CE cULus

Model number : F5PAE140P100 Power supply : DC24V/48V

Motor

Motor size : 28mm sq. (1.10inch sq.), 42mm sq. (1.65inch sq.), 60mm sq. (2.36inch sq.), φ86mm. (φ3.39inch)

Cables with connectors

- Power supply, Input/output signal, Motor (1m each)
- Instruction manuals can be downloaded from our website.

System configuration

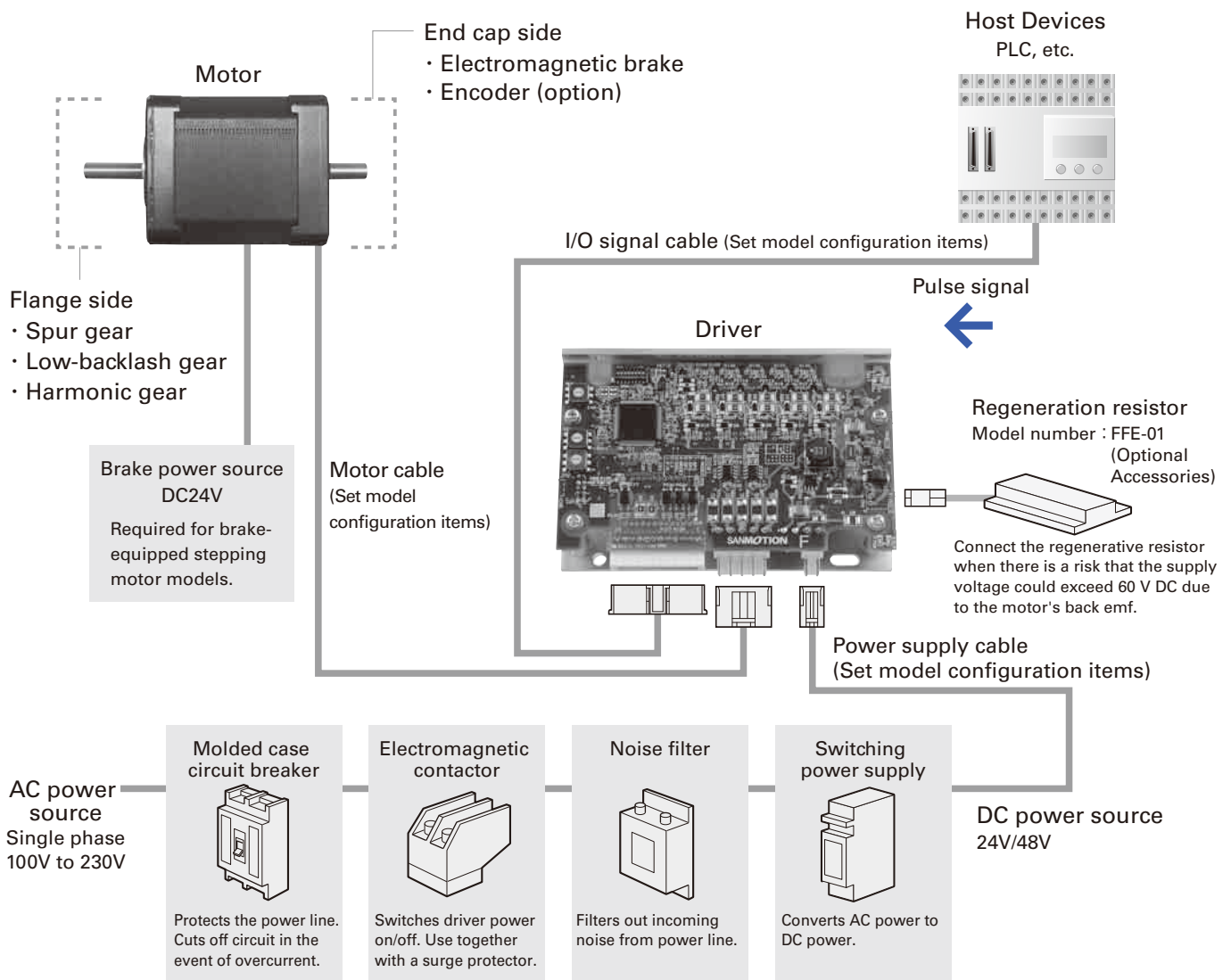

Model number convention

Example: The model number of the set with a DC input micro-step driver and motor model 103F7851-82CXA4 is composed as follows. This motor is specified as 60mm sq. (2.36inch sq.) and 92mm (3,62inch) long (motor + gear), single shaft, with low backlash gears.

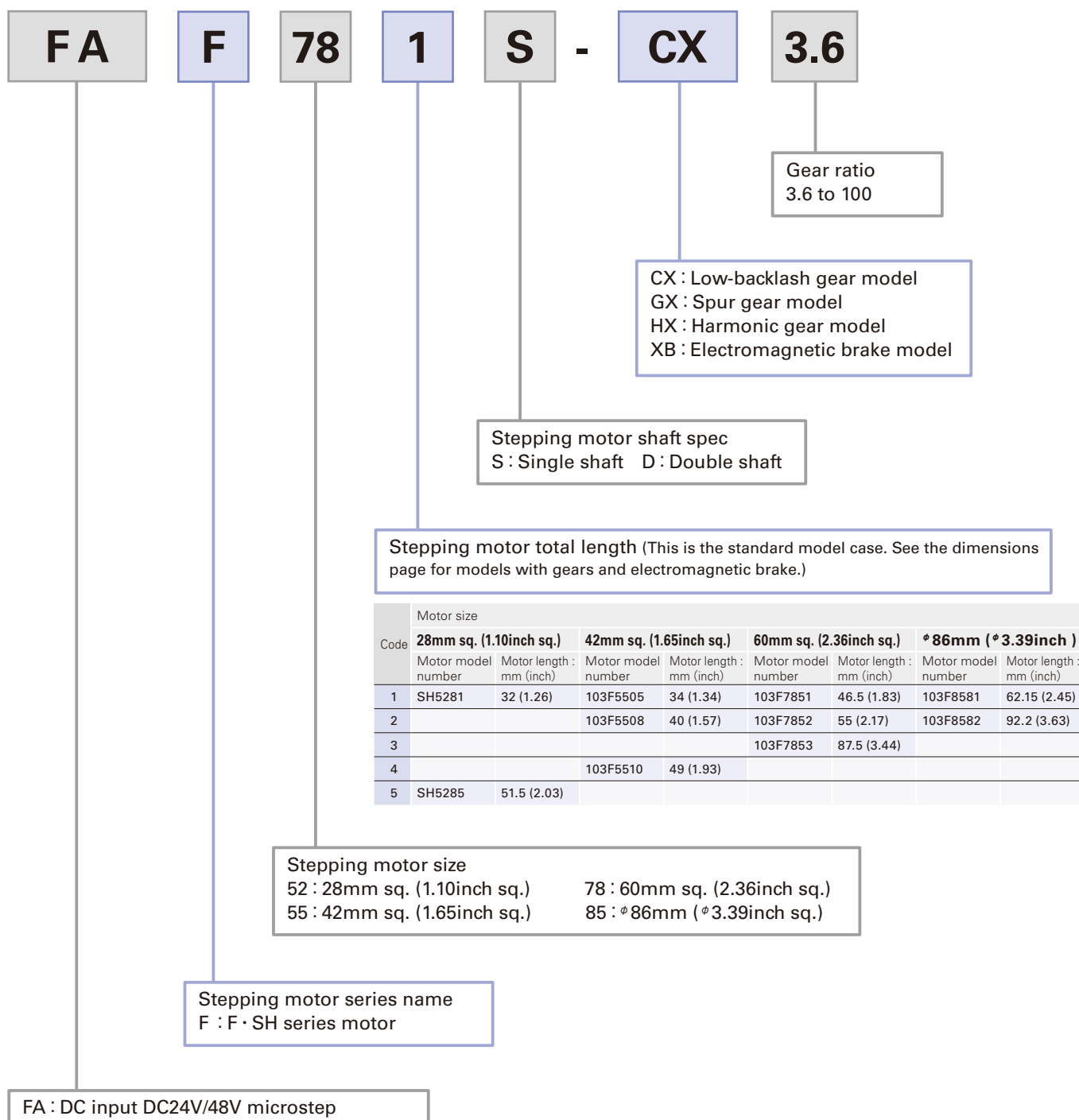

AC input Set model
Micro step

DC input Set model
Micro step

DC input Set model
Full / half step

Stepping Motor

Linear Actuator
Stepping Motor

Stepping motor for
vacuum environment

Dimensions

Set Model Configuration Each set consists of a driver, motor, and cables with connectors

DC input driver Model No. : F5PAE140P100

Basic step angle/0.72°

Model	Motor size	Single shaft		Double shaft		Rated current (A/phase)	Page		
		Set model number	Set model configuration items	Set model number	Set model configuration items		Specifications	Dimensions	
			Motor model number		Motor model number				
Standard model	28mm sq. (1.10inch sq.)	FAF521S	SH5281-7241	FAF521D	SH5281-7211	0.75	P.38	P.97	
		FAF525S	SH5285-7241	FAF525D	SH5285-7211	0.75	P.38	P.97	
	42mm sq. (1.65inch sq.)	FAF551S	103F5505-8241	FAF551D	103F5505-8211	1.4	P.38	P.97	
		FAF552S	103F5508-8241	FAF552D	103F5508-8211	1.4	P.38	P.97	
		FAF554S	103F5510-8241	FAF554D	103F5510-8211	1.4	P.39	P.97	
	60mm sq. (2.36inch sq.)	FAF781S	103F7851-8241	FAF781D	103F7851-8211	1.4	P.39	P.98	
		FAF782S	103F7852-8241	FAF782D	103F7852-8211	1.4	P.39	P.98	
		FAF783S	103F7853-8241	FAF783D	103F7853-8211	1.4	P.39	P.98	
	φ 86mm (*3.39inch)	FAF851S	103F8581-8241	FAF851D	103F8581-8211	1.4	P.40	P.99	
		FAF852S	103F8582-8241	FAF852D	103F8582-8211	1.4	P.40	P.99	
Low-backlash gear model	42mm sq. (1.65inch sq.)	FAF551S-CX3.6	103F5505-82CXA4	FAF551D-CX3.6	103F5505-82CXA1	1.4	P.41	P.101	
		FAF551S-CX7.2	103F5505-82CXB4	FAF551D-CX7.2	103F5505-82CXB1	1.4	P.41	P.101	
		FAF551S-CX10	103F5505-82CXE4	FAF551D-CX10	103F5505-82CXE1	1.4	P.41	P.101	
		FAF551S-CX20	103F5505-82CXG4	FAF551D-CX20	103F5505-82CXG1	1.4	P.41	P.101	
		FAF551S-CX30	103F5505-82CXJ4	FAF551D-CX30	103F5505-82CXJ1	1.4	P.42	P.101	
		FAF551S-CX36	103F5505-82CXC4	FAF551D-CX36	103F5505-82CXC1	1.4	P.42	P.101	
	60mm sq. (2.36inch sq.)	FAF781S-CX3.6	103F7851-82CXA4	FAF781D-CX3.6	103F7851-82CXA1	1.4	P.42	P.101	
		FAF781S-CX7.2	103F7851-82CXB4	FAF781D-CX7.2	103F7851-82CXB1	1.4	P.42	P.101	
		FAF781S-CX10	103F7851-82CXE4	FAF781D-CX10	103F7851-82CXE1	1.4	P.43	P.101	
		FAF781S-CX20	103F7851-82CXG4	FAF781D-CX20	103F7851-82CXG1	1.4	P.43	P.101	
		FAF781S-CX30	103F7851-82CXJ4	FAF781D-CX30	103F7851-82CXJ1	1.4	P.43	P.101	
		FAF781S-CX36	103F7851-82CXC4	FAF781D-CX36	103F7851-82CXC1	1.4	P.43	P.101	
	φ 86mm (*3.39inch)	FAF851S-CX3.6	103F8581-82CXA4	FAF851D-CX3.6	103F8581-82CXA1	1.4	P.44	P.101	
		FAF851S-CX7.2	103F8581-82CXB4	FAF851D-CX7.2	103F8581-82CXB1	1.4	P.44	P.101	
		FAF851S-CX10	103F8581-82CXE4	FAF851D-CX10	103F8581-82CXE1	1.4	P.44	P.101	
		FAF851S-CX20	103F8581-82CXG4	FAF851D-CX20	103F8581-82CXG1	1.4	P.44	P.101	
		FAF851S-CX30	103F8581-82CXJ4	FAF851D-CX30	103F8581-82CXJ1	1.4	P.45	P.101	
		FAF851S-CX36	103F8581-82CXC4	FAF851D-CX36	103F8581-82CXC1	1.4	P.45	P.101	
	Spur gear model	28mm sq. (1.10inch sq.)	FAF521S-GX3.6	SH5281-72GXA4	FAF521D-GX3.6	SH5281-72GXA1	0.75	P.46	P.102
			FAF521S-GX7.2	SH5281-72GXB4	FAF521D-GX7.2	SH5281-72GXB1	0.75	P.46	P.102
			FAF521S-GX10	SH5281-72GXE4	FAF521D-GX10	SH5281-72GXE1	0.75	P.46	P.102
			FAF521S-GX20	SH5281-72GXG4	FAF521D-GX20	SH5281-72GXG1	0.75	P.46	P.102
			FAF521S-GX30	SH5281-72GXJ4	FAF521D-GX30	SH5281-72GXJ1	0.75	P.47	P.102
			FAF521S-GX50	SH5281-72GXL4	FAF521D-GX50	SH5281-72GXL1	0.75	P.47	P.102
Harmonic gear model	28mm sq. (1.10inch sq.)	FAF521S-HX50	SH5281-72HXL4	FAF521D-HX50	SH5281-72HXL1	0.75	P.48	P.102	
		FAF521S-HX100	SH5281-72HXM4	FAF521D-HX100	SH5281-72HXM1	0.75	P.48	P.102	
	42mm sq. (1.65inch sq.)	FAF551S-HX30	103F5505-82HXJ5	FAF551D-HX30	103F5505-82HXJ2	1.4	P.48	P.102	
		FAF551S-HX50	103F5505-82HXL5	FAF551D-HX50	103F5505-82HXL2	1.4	P.48	P.102	
		FAF551S-HX100	103F5505-82HXM5	FAF551D-HX100	103F5505-82HXM2	1.4	P.49	P.102	
	60mm sq. (2.36inch sq.)	FAF781S-HX50	103F7851-82HXL4	FAF781D-HX50	103F7851-82HXL1	1.4	P.49	P.103	
		FAF781S-HX100	103F7851-82HXM4	FAF781D-HX100	103F7851-82HXM1	1.4	P.49	P.103	
		φ 86mm (*3.39inch)	FAF851S-HX50	103F8581-82HXL4	FAF851D-HX50	103F8581-82HXL1	1.4	P.49	P.103
		FAF851S-HX100	103F8581-82HXM4	FAF851D-HX100	103F8581-82HXM1	1.4	P.50	P.103	
Electromagnetic brake model	42mm sq. (1.65inch sq.)	FAF551S-XB	103F5505-82XB41	—	—	1.4	P.51	P.104	
		FAF552S-XB	103F5508-82XB41	—	—	1.4	P.51	P.104	
		FAF554S-XB	103F5510-82XB41	—	—	1.4	P.51	P.104	
	60mm sq. (2.36inch sq.)	FAF781S-XB	103F7851-82XB41	—	—	1.4	P.51	P.104	
		FAF782S-XB	103F7852-82XB41	—	—	1.4	P.52	P.104	
		FAF783S-XB	103F7853-82XB41	—	—	1.4	P.52	P.104	
	φ 86mm (*3.39inch)	FAF851S-XB	103F8581-82XB41	—	—	1.4	P.52	P.104	
		FAF852S-XB	103F8582-82XB41	—	—	1.4	P.52	P.104	

● **Cables with connectors** Included in all DC input sets (micro-step)

Power supply cable (Model number : FC3P0010A)

Pin number	Color
1	White
2	Black

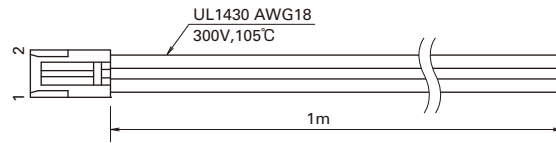

Stepping Motor Extension Cable (Model number : FC3M0010A)

Pin number	Color
1	Blue
2	Red
3	Orange
4	Green
5	Black

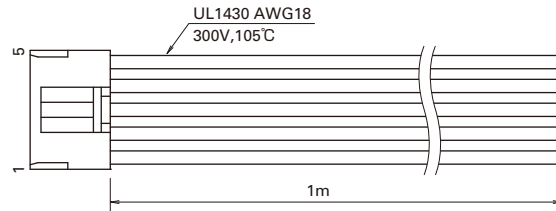

I/O signal cable (Model number : FC3S0010A)

Pin number	Color
1	Blue
2	
3	
4	
5	
6	
7	
8	
9	
10	
11	
12	

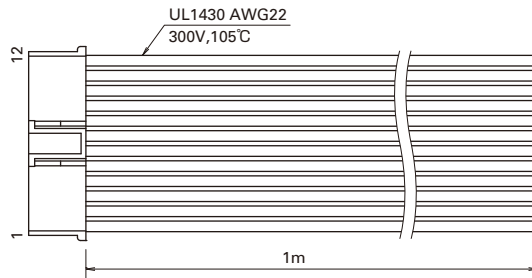

Optional Accessories

● **Regeneration resistor**

Use when main supply voltage could exceed 60 V DC.

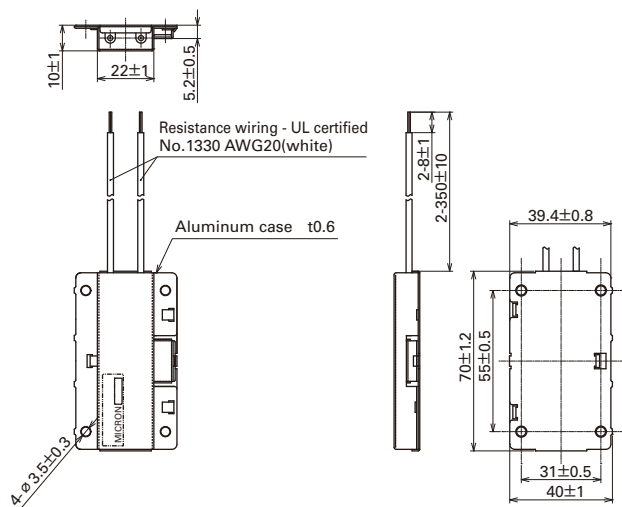

Model number	FFE-01
Rated current	60W (with installed in aluminum heatsink 210 x 120 x t2)
Nominal resistance (Nominal standard resistance value)	20 Ω
Resistance value allowable tolerance	± 5%
Insulation resistance	100M Ω or over at DC500V megohm (between conductive part of cord and aluminum case)
Withstand voltage	AC2000V, for 1 minute (between conductive part of cord and aluminum case)
Instantaneous load tolerance	580J [The amount of energy that resistor can consume for 1 minute (only once).]
Accessory	Terminal box Model No. FK-MC0,5/2-ST2,5 (PHONENIX CONTACT GmbH & Co. KG)

Standard model DC input Driver (Model number : F5PAE140P100) + Standard motor

Basic step angle : 0.72° Rated current : 28mm sq. (1.10inch sq.) Motor 0.75A/phase, 42mm sq. (1.65inch sq.) to 86mm (3.39inch) Motor 1.4A/phase

Motor size		28mm sq. (1.10inch sq.)		42mm sq. (1.65inch sq.)	
		32mm (1.26inch)	51.5mm (2.03inch)	34mm (1.34inch)	40mm (1.57inch)
Single shaft	Set ordering model no.	FAF521S	FAF525S	FAF551S	FAF552S
	Corresponding motor model number	SH5281-7241	SH5285-7241	103F5505-8241	103F5508-8241
Double shaft	Set ordering model no.	FAF521D	FAF525D	FAF551D	FAF552D
	Corresponding motor model number	SH5281-7211	SH5285-7211	103F5505-8211	103F5508-8211
Holding torque	N · m (OZ · in)	0.041 (5.81)	0.078 (11.05)	0.13 (18.41)	0.18 (25.49)
Rotor inertia	$\times 10^{-4} \text{kg} \cdot \text{m}^2$ (OZ · in ²)	0.01 (0.05)	0.022 (0.09)	0.03 (0.16)	0.053 (0.29)
Motor mass ^(Note1)	kg (lbs)	0.11 (0.22)	0.2 (0.44)	0.23 (0.50)	0.28 (0.62)
Allowable thrust load	N (lbs)	3 (0.68)	3 (0.68)	10 (2.25)	10 (2.25)
Allowable radial load ^(Note2)	N (lbs)	47 (10.57)	53 (11.91)	35 (8.75)	35 (8.75)

(Note1) Driver mass ▶ P.54

(Note2) When load is applied at 1/3 length from output shaft edge.

Characteristics

Use the rubber coupling

Allowable torque Full step — Pull-out torque Half step — fs : Maximum self-start frequency when not loaded Full step ● Half step ●
 Source current (no load) Full step - - - - - Half step - - - - - Source current (load applied) Full step ····· Half step ·····

**FAF521S
FAF521D**

Operating current : 0.75A/phase

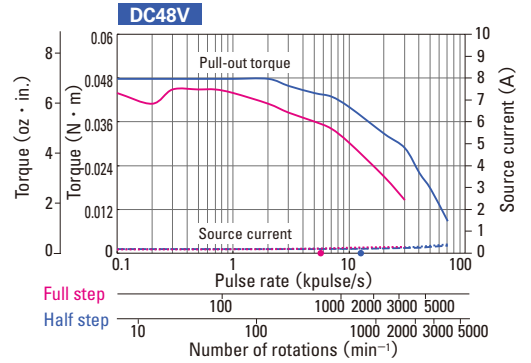
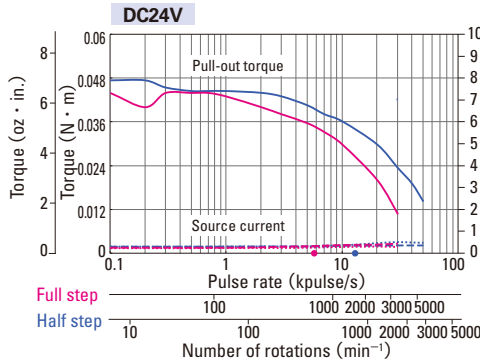

**FAF525S
FAF525D**

Operating current : 0.75A/phase

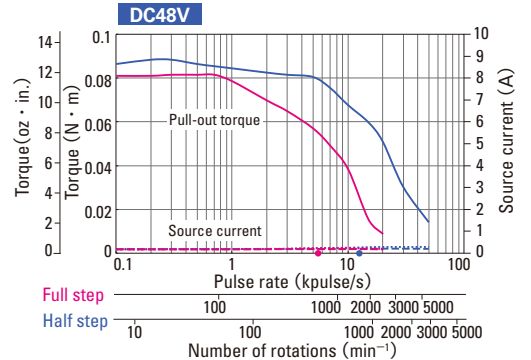
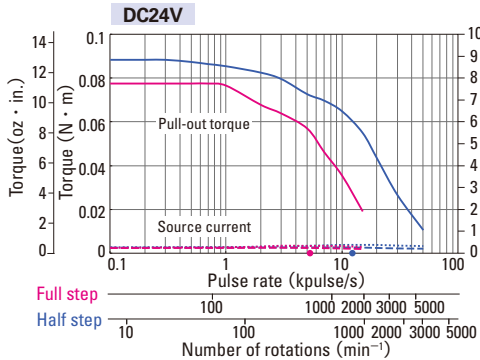

**FAF551S
FAF551D**

Operating current : 1.4A/phase

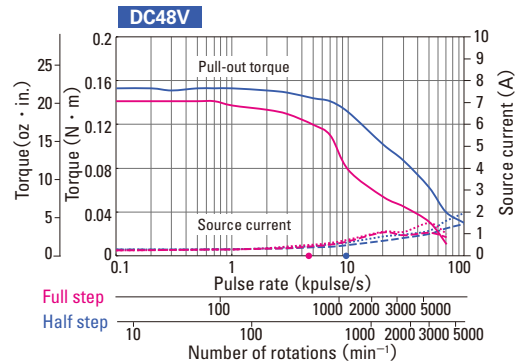
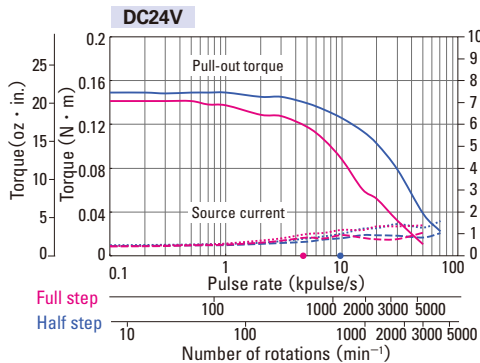

**FAF552S
FAF552D**

Operating current : 1.4A/phase

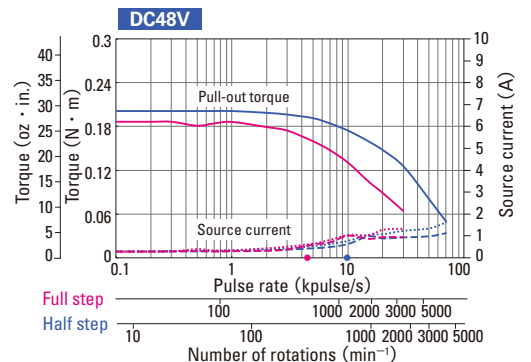
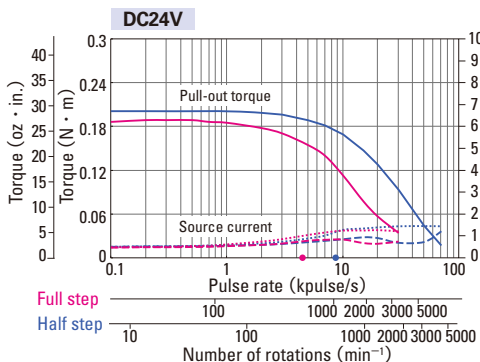

System configuration ▶ P.34 Set Model Configuration ▶ P.36 Motor dimensions ▶ P.97 to P.100 Driver dimensions ▶ P.105 The data are measured under the drive condition of our company. The drive torque may very depending on the accuracy of customer -side equipment.

Motor size		42mm sq. (1.65inch sq.)	60mm sq. (2.36inch sq.)		
Motor length		49mm (1.93inch)	46.5mm (1.83inch)	55mm (2.17inch)	87.5mm (3.45inch)
Single shaft	Set ordering model no.	FAF554S	FAF781S	FAF782S	FAF783S
	Corresponding motor model number	103F5510-8241	103F7851-8241	103F7852-8241	103F7853-8241
Double shaft	Set ordering model no.	FAF554D	FAF781D	FAF782D	FAF783D
	Corresponding motor model number	103F5510-8211	103F7851-8211	103F7852-8211	103F7853-8211
Holding torque	N · m (OZ · in)	0.25 (35.4)	0.55 (77.9)	0.87 (123.2)	1.67 (236.5)
Rotor inertia	$\times 10^{-4} \text{kg} \cdot \text{m}^2$ (OZ · in ²)	0.065 (0.36)	0.275 (1.50)	0.4 (2.19)	0.84 (4.59)
Motor mass ^(Note1)	kg (lbs)	0.37 (0.81)	0.6 (1.32)	0.78 (1.72)	1.36 (3.0)
Allowable thrust load	N (lbs)	10 (2.25)	20 (4.5)	20 (4.5)	20 (4.5)
Allowable radial load ^(Note2)	N (lbs)	35 (8.75)	80 (18)	80 (18)	80 (18)

(Note1) Driver mass ▶ P.54

(Note2) When load is applied at 1/3 length from output shaft edge.

Characteristics

Operating current : 1.4A/phase
Use the rubber coupling

Pull-out torque Full step ——— Half step ——— fs : Maximum self-start frequency when not loaded Full step ● Half step ●
Source current (no load) Full step - - - - - Half step - - - - - Source current (load applied) Full step Half step

FAF554S FAF554D

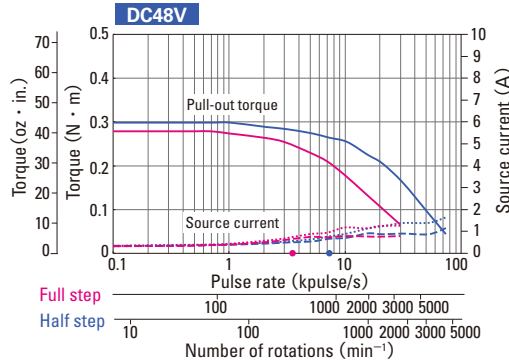
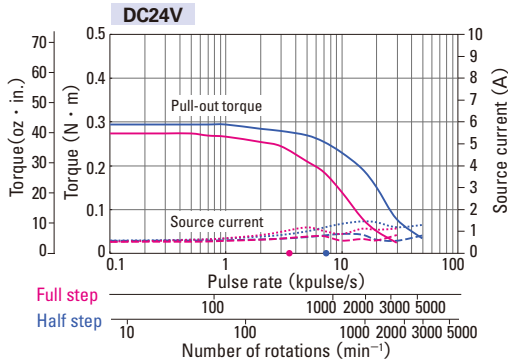

FAF781S FAF781D

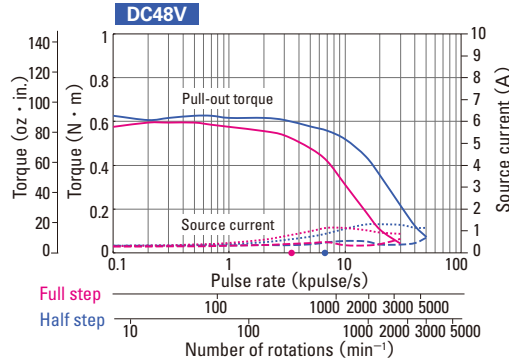
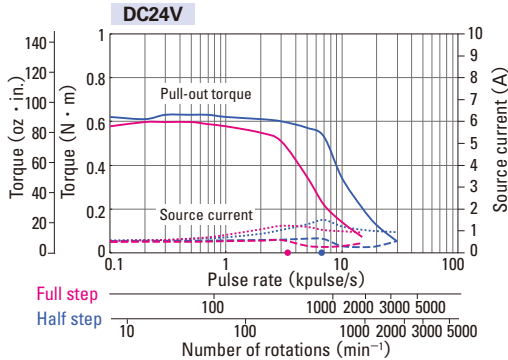

FAF782S FAF782D

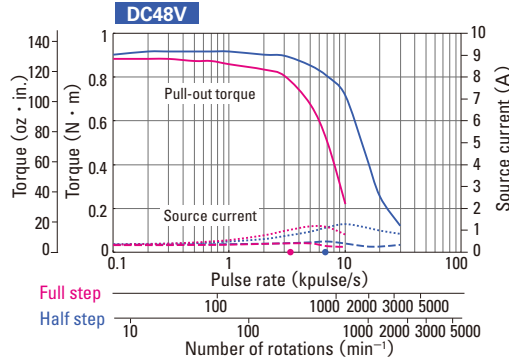
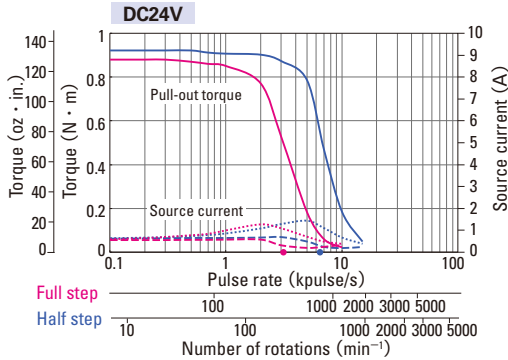

FAF783S FAF783D

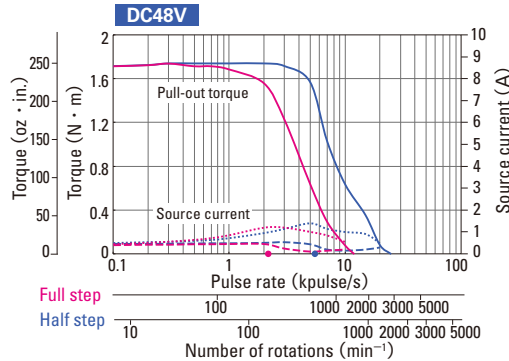
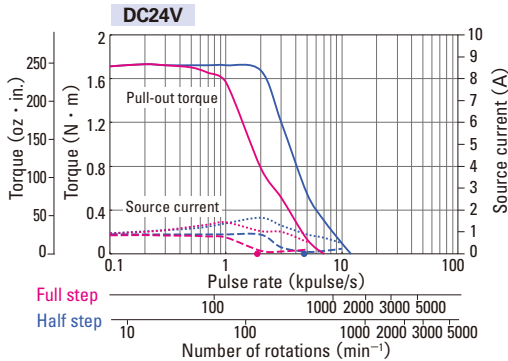

System configuration ▶ P.34 Set Model Configuration ▶ P.36 Motor dimensions ▶ P.97 to P.100 Driver dimensions ▶ P.105 The data are measured under the drive condition of our company. The drive torque may very depending on the accuracy of customer -side equipment.

Standard model DC input Driver (Model number : F5PAE140P100) + Standard motor

Basic step angle : 0.72° Rated current : 28mm sq. (1.10inch sq.) Motor 0.75A/phase, 42mm sq.(1.65inch sq.) to φ86mm(φ3.39inch) Motor 1.4A/phase

Motor size		φ86mm (φ3.39inch)	
Motor length		62.15mm (2.47inch)	92.2mm (3.63inch)
Single shaft	Set ordering model no.	FAF851S	FAF852S
	Corresponding motor model number	103F8581-8241	103F8582-8241
Double shaft	Set ordering model no.	FAF851D	FAF852D
	Corresponding motor model number	103F8581-8211	103F8582-8211
Holding torque	N · m (OZ · in)	2 (283.2)	4.02 (569.3)
Rotor inertia	× 10 ⁻⁴ kg · m ² (OZ · in ²)	1.45 (7.93)	2.9 (15.86)
Motor mass ^(Note1)	kg (lbs)	1.5 (3.3)	2.5 (5.5)
Allowable thrust load	N (lbs)	60 (13.5)	60 (13.5)
Allowable radial load ^(Note2)	N (lbs)	220 (49.5)	220 (49.5)

(Note1) Driver mass ▶ P.54

(Note2) When load is applied at 1/3 length from output shaft edge.

Characteristics

Operating current : 1.4A/phase
Use the rubber coupling

Pull-out torque Full step — Half step — fs : Maximum self-start frequency when not loaded
Source current (no load) Full step - - - Half step - - - Source current (load applied) Full step ● Half step ●

FAF851S
FAF851D

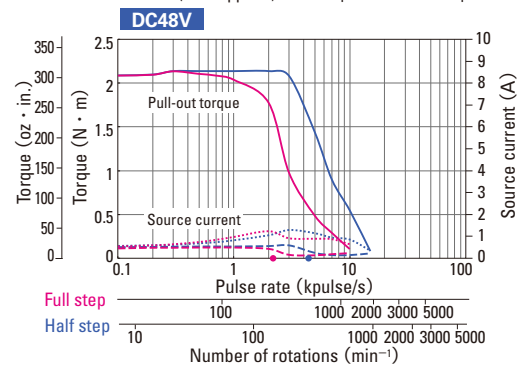
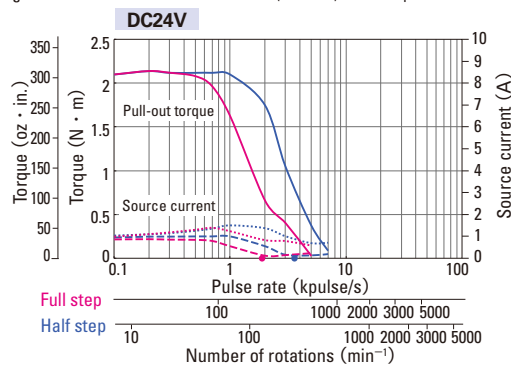

FAF852S
FAF852D

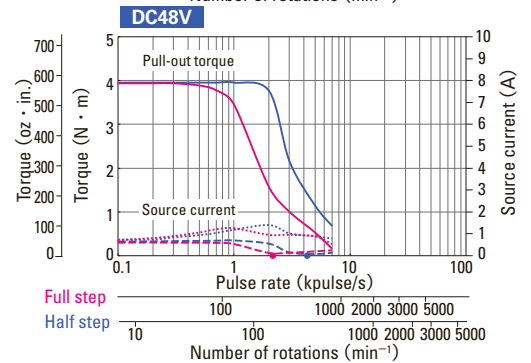
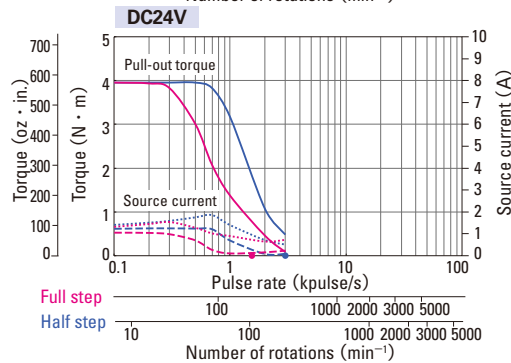

Low-backlash gear model

DC input Driver (Model number : F5PAE140P100) + Motor with low-backlash gear

Rated current : 1.4A/phase

Motor size		42mm sq. (1.65inch sq.)			
Motor + gear length		64.5mm (2.54inch)	64.5mm (2.54inch)	64.5mm (2.54inch)	64.5mm (2.54inch)
Single shaft	Set ordering model no.	FAF551S-CX3.6	FAF551S-CX7.2	FAF551S-CX10	FAF551S-CX20
	Corresponding motor model number	103F5505-82CXA4	103F5505-82CXB4	103F5505-82CXE4	103F5505-82CXG4
Double shaft	Set ordering model no.	FAF551D-CX3.6	FAF551D-CX7.2	FAF551D-CX10	FAF551D-CX20
	Corresponding motor model number	103F5505-82CXA1	103F5505-82CXB1	103F5505-82CXE1	103F5505-82CXG1
Allowable torque	N · m (OZ · in)	0.343 (48.6)	0.686 (97.1)	0.98 (138.8)	1.47 (208.2)
Rotor inertia	$\times 10^{-4}$ kg · m ² (OZ · in ²)	0.03 (0.16)	0.03 (0.16)	0.03 (0.16)	0.03 (0.16)
Basic step angle	DEG	0.2	0.1	0.072	0.036
Gear ratio	-	1 : 3.6	1 : 7.2	1 : 10	1 : 20
Backlash	DEG	0.6	0.4	0.35	0.25
Allowable speed	min ⁻¹	500	250	180	90
Motor mass ^(Note1)	kg (lbs)	0.36 (0.79)	0.36 (0.79)	0.36 (0.79)	0.36 (0.79)
Allowable thrust load	N (lbs)	15 (3.38)	15 (3.38)	15 (3.38)	15 (3.38)
Allowable radial load ^(Note2)	N (lbs)	20 (4.5)	20 (4.5)	20 (4.5)	20 (4.5)

Directions of motor rotation and gear output shaft are the same for models with reduction ratio 1 : 3.6, 1 : 7.2 and 1 : 10 opposite for reduction ratio 1 : 20, 1 : 30, and 1 : 36.

(Note1) Driver mass ▶ P.54

(Note2) When load is applied at 1/3 length from output shaft edge.

Characteristics

Operating current : 1.4A/phase
Use the rubber coupling

Allowable torque Full step — Half step —
Source current (no load) Full step - - - Half step - - -
Source current (load applied) Full step ····· Half step ·····

FAF551S-CX3.6
FAF551D-CX3.6

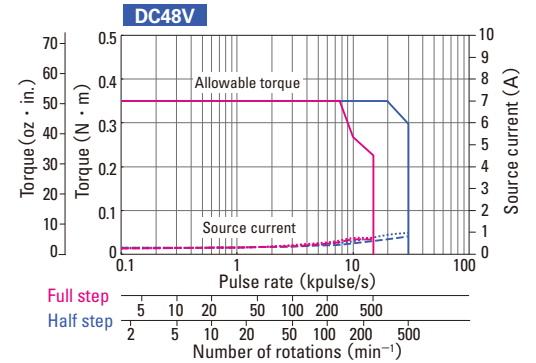
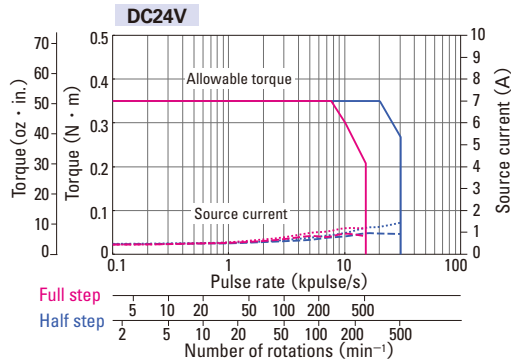

FAF551S-CX7.2
FAF551D-CX7.2

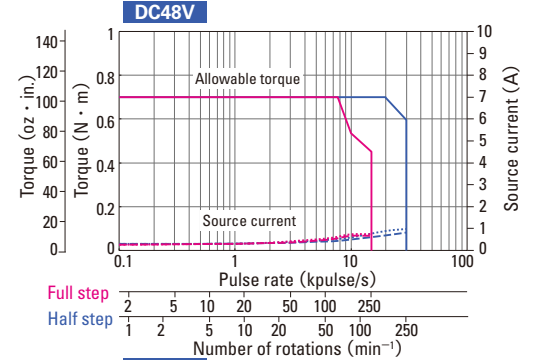
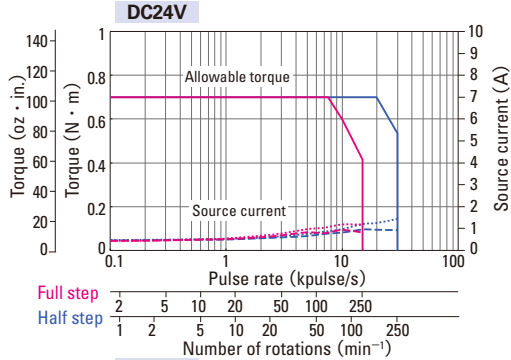

FAF551S-CX10
FAF551D-CX10

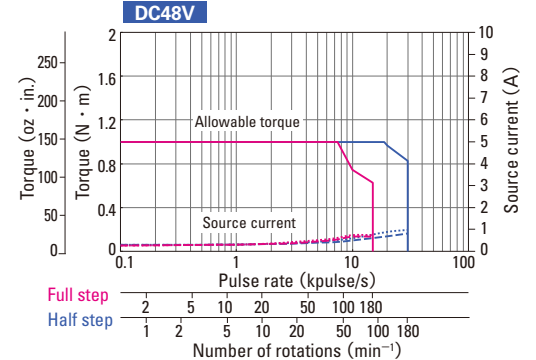
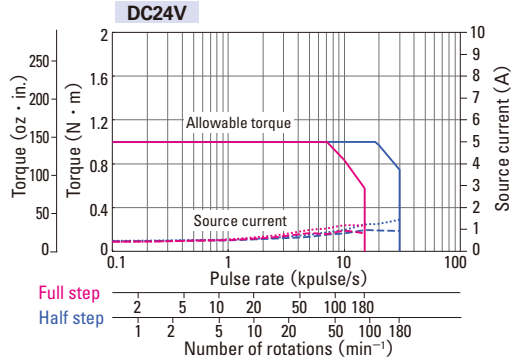

FAF551S-CX20
FAF551D-CX20

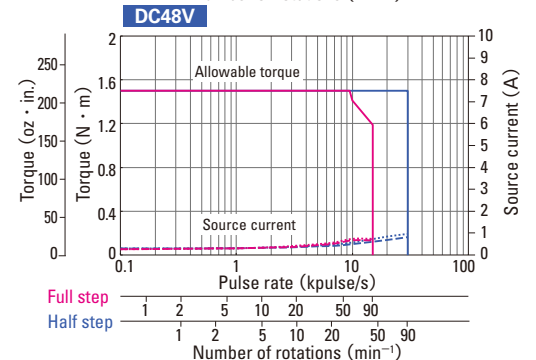
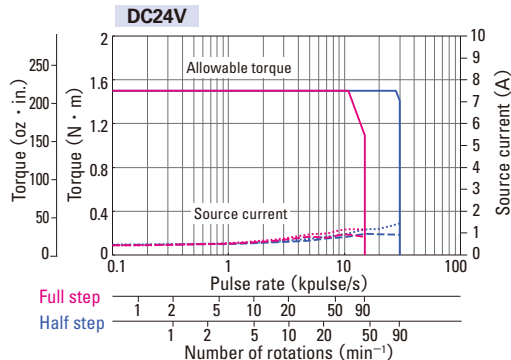

In motor+gear models, the gears may be damaged if allowable torque is exceeded. When selecting a motor, ensure that its allowable torque will not be exceeded. System configuration ▶ P.34 Set Model Configuration ▶ P.36 Motor dimensions ▶ P.101 Driver dimensions ▶ P.105 The data are measured under the drive condition of our company. The drive torque may very depending on the accuracy of customer-side equipment.

AC input Set model
Micro step

DC input Set model
Micro step

DC input Set model
Full / half step

Stepping Motor

Linear Actuator
Stepping Motor

Stepping motor for
vacuum environment

Dimensions

Low-backlash gear model

DC input Driver (Model number : F5PAE140P100) + Motor with low-backlash gear

Rated current : 1.4A/phase

Motor size		42mm sq. (1.65inch sq.)		60mm sq. (2.36inch sq.)	
Motor + gear length		64.5mm (2.54inch)	64.5mm (2.54inch)	92mm (3.62inch)	92mm (3.62inch)
Single shaft	Set ordering model no.	FAF551S-CX30	FAF551S-CX36	FAF781S-CX3.6	FAF781S-CX7.2
	Corresponding motor model number	103F5505-82CXJ4	103F5505-82CXK4	103F7851-82CXA4	103F7851-82CXB4
Double shaft	Set ordering model no.	FAF551D-CX30	FAF551D-CX36	FAF781D-CX3.6	FAF781D-CX7.2
	Corresponding motor model number	103F5505-82CXJ1	103F5505-82CXK1	103F7851-82CXA1	103F7851-82CXB1
Allowable torque	N · m (OZ · in)	1.47 (208.2)	1.47 (208.2)	1.25 (177.0)	2.5 (354.0)
Rotor inertia	$\times 10^{-4}$ kg · m ² (OZ · in ²)	0.03 (0.16)	0.03 (0.16)	0.275 (1.5)	0.275 (1.5)
Basic step angle	DEG	0.024	0.02	0.2	0.1
Gear ratio	-	1 : 30	1 : 36	1 : 3.6	1 : 7.2
Backlash	DEG	0.25	0.25	0.55	0.25
Allowable speed	min ⁻¹	60	50	500	250
Motor mass ^(Note1)	kg (lbs)	0.36 (0.79)	0.36 (0.79)	0.97 (2.13)	0.97 (2.13)
Allowable thrust load	N (lbs)	15 (3.38)	15 (3.38)	30 (6.75)	30 (6.75)
Allowable radial load ^(Note2)	N (lbs)	20 (4.5)	20 (4.5)	100 (22.5)	100 (22.5)

The directions of motor rotation and gear output axle rotation for 42 mm models are the same for 1:3.6, 1:7.2 and 1:10 reduction ratios, and opposite for 1:20, 1:30 and 1:36 reduction ratios. For 60 mm models, rotation directions are the same for 1:3.6 and 1:7.2 reduction ratios, and opposite for 1:10, 1:20, 1:30 and 1:36 reduction ratios.

(Note1) Driver mass ▶ P.54

(Note2) When load is applied at 1/3 length from output shaft edge.

Characteristics

Operating current : 1.4A/phase
Use the rubber coupling

Allowable torque Full step — Half step —
Source current (no load) Full step - - - Half step - - -
Source current (load applied) Full step ····· Half step ·····

FAF551S-CX30
FAF551D-CX30

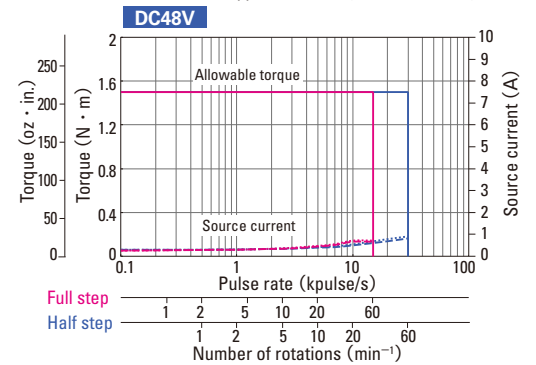
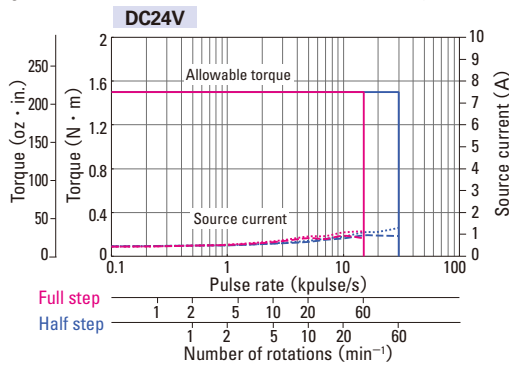

FAF551S-CX36
FAF551D-CX36

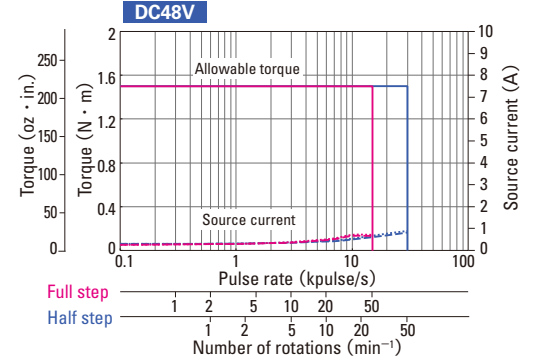
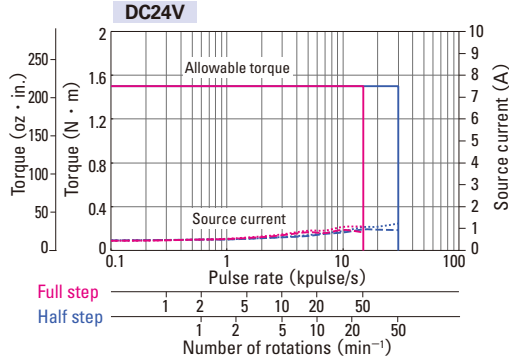

FAF781S-CX3.6
FAF781D-CX3.6

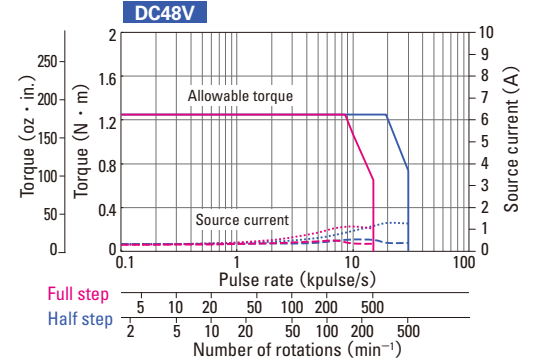
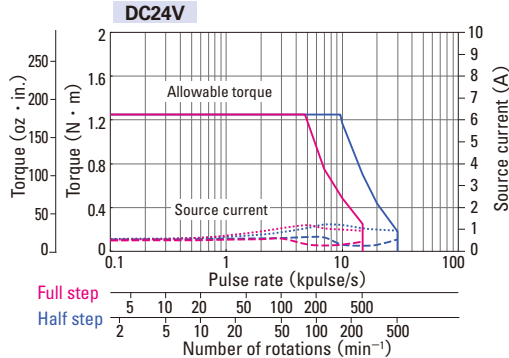

FAF781S-CX7.2
FAF781D-CX7.2

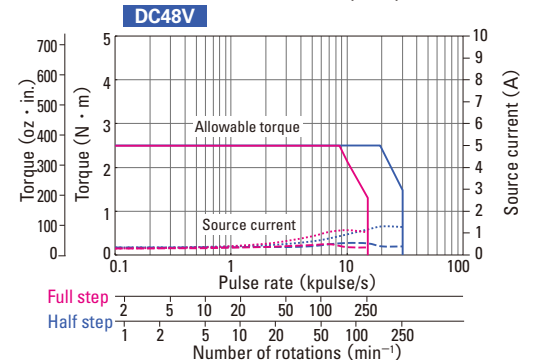
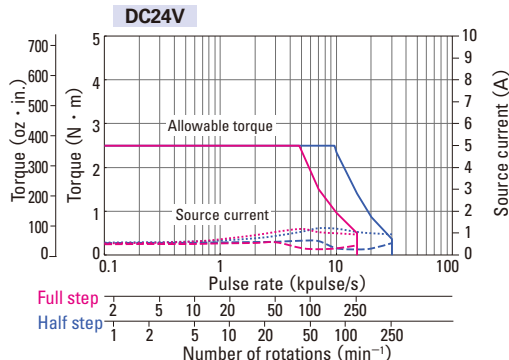

Motor size		60mm sq. (2.36inch sq.)			
Motor + gear length		92mm (3.62inch)	92mm (3.62inch)	92mm (3.62inch)	92mm (3.62inch)
Single shaft	Set ordering model no.	FAF781S-CX10	FAF781S-CX20	FAF781S-CX30	FAF781S-CX36
	Corresponding motor model number	103F7851-82CXE4	103F7851-82CXG4	103F7851-82CXJ4	103F7851-82CXK4
Double shaft	Set ordering model no.	FAF781D-CX10	FAF781D-CX20	FAF781D-CX30	FAF781D-CX36
	Corresponding motor model number	103F7851-82CXE1	103F7851-82CXG1	103F7851-82CXJ1	103F7851-82CXK1
Allowable torque	N · m (OZ · in)	3 (424.8)	3.5 (495.6)	4 (566.4)	4 (566.4)
Rotor inertia	$\times 10^{-4} \text{kg} \cdot \text{m}^2$ (OZ · in ²)	0.275 (1.5)	0.275 (1.5)	0.275 (1.5)	0.275 (1.5)
Basic step angle	DEG	0.072	0.036	0.024	0.02
Gear ratio	-	1 : 10	1 : 20	1 : 30	1 : 36
Backlash	DEG	0.25	0.17	0.17	0.17
Allowable speed	min ⁻¹	180	90	60	50
Motor mass ^(Note1)	kg (lbs)	0.97 (2.13)	0.97 (2.13)	0.97 (2.13)	0.97 (2.13)
Allowable thrust load	N (lbs)	30 (6.75)	30 (6.75)	30 (6.75)	30 (6.75)
Allowable radial load ^(Note2)	N (lbs)	100 (22.5)	100 (22.5)	100 (22.5)	100 (22.5)

The directions of motor rotation and gear output axle rotation are the same for models with reduction ratio 1:3.6 and 1:7.2 reduction ratios, and opposite for 1:10, 1:20, 1:30 and 1:36 reduction ratios.

(Note1) Driver mass ▶ P.54

(Note2) When load is applied at 1/3 length from output shaft edge.

Characteristics

Operating current : 1.4A/phase
Use the rubber coupling

Allowable torque Full step — Half step —
Source current (no load) Full step - - - Half step - - -

Source current (load applied) Full step ····· Half step ·····

FAF781S-CX10
FAF781D-CX10

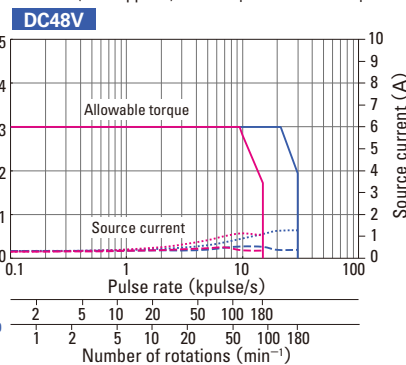
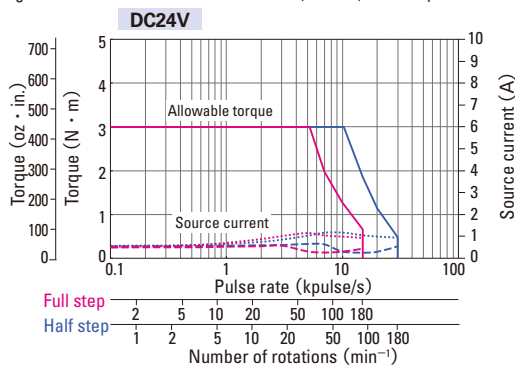

FAF781S-CX20
FAF781D-CX20

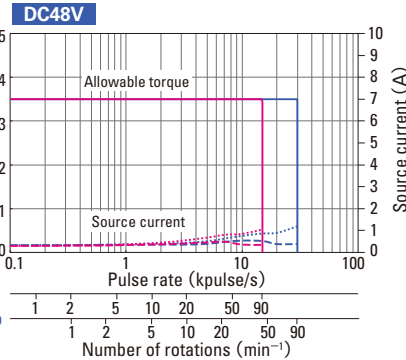
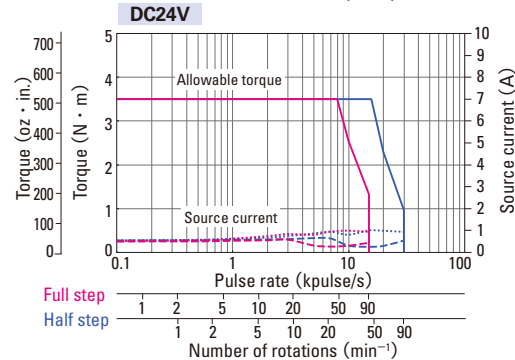

FAF781S-CX30
FAF781D-CX30

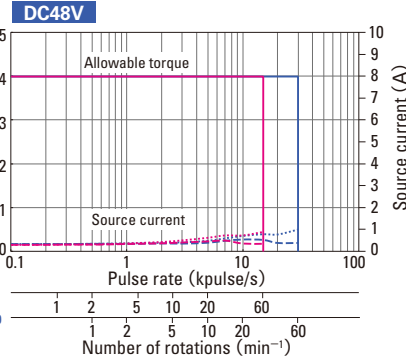
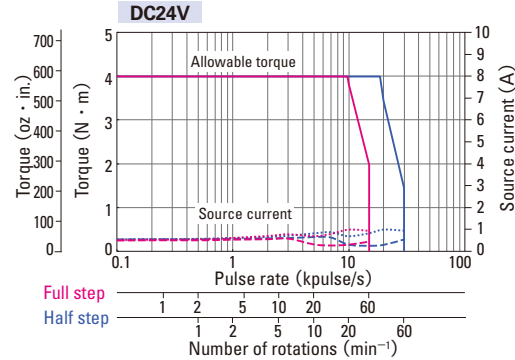

FAF781S-CX36
FAF781D-CX36

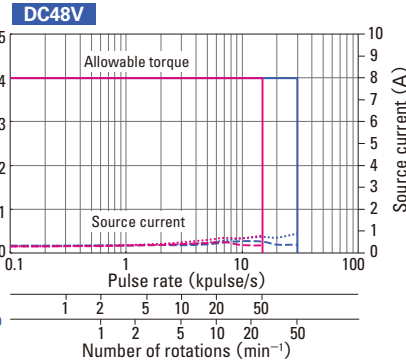
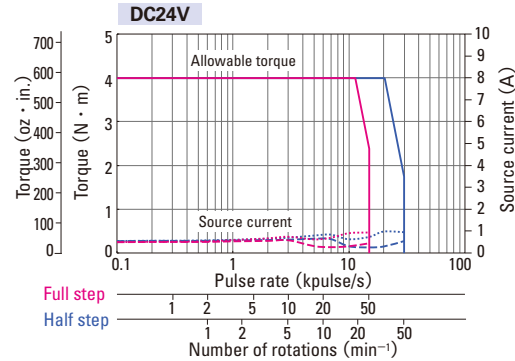

In motor+gear models, the gears may be damaged if allowable torque is exceeded. When selecting a motor, ensure that its allowable torque will not be exceeded. System configuration ▶ P.34 Set Model Configuration ▶ P.36 Motor dimensions ▶ P.101 Driver dimensions ▶ P.105 The data are measured under the drive condition of our company. The drive torque may very depending on the accuracy of customer-side equipment.

Low-backlash gear model

DC input Driver (Model number : F5PAE140P100) + Motor with low-backlash gear

Rated current : 1.4A/phase

Motor size		φ86mm (φ3.39inch)			
Motor + gear length		127.3mm (5.01inch)	127.3mm (5.01inch)	127.3mm (5.01inch)	127.3mm (5.01inch)
Single shaft	Set ordering model no.	FAF851S-CX3.6	FAF851S-CX7.2	FAF851S-CX10	FAF851S-CX20
	Corresponding motor model number	103F8581-82CX4A	103F8581-82CXB4	103F8581-82CXE4	103F8581-82CXG4
Double shaft	Set ordering model no.	FAF851D-CX3.6	FAF851D-CX7.2	FAF851D-CX10	FAF851D-CX20
	Corresponding motor model number	103F8581-82CXA1	103F8581-82CXB1	103F8581-82CXE1	103F8581-82CXG1
Allowable torque	N · m (OZ · in)	4.5 (637.2)	9 (1274.5)	9 (1274.5)	12 (1699.3)
Rotor inertia	$\times 10^{-4}$ kg · m ² (OZ · in ²)	1.45 (7.93)	1.45 (7.93)	1.45 (7.93)	1.45 (7.93)
Basic step angle	DEG	0.2	0.1	0.072	0.036
Gear ratio	-	1 : 3.6	1 : 7.2	1 : 10	1 : 20
Backlash	DEG	0.35	0.22	0.22	0.15
Allowable speed	min ⁻¹	500	250	180	90
Motor mass ^(Note1)	kg (lbs)	2.7 (5.94)	2.7 (5.94)	2.7 (5.94)	2.7 (5.94)
Allowable thrust load	N (lbs)	60 (13.5)	60 (13.5)	60 (13.5)	60 (13.5)
Allowable radial load ^(Note2)	N (lbs)	300 (67.5)	300 (67.5)	300 (67.5)	300 (67.5)

The directions of motor rotation and gear output axle rotation are the same for models with reduction ratio 1:3.6 and 1:7.2 reduction ratios, and opposite for 1:10, 1:20, 1:30 and 1:36 reduction ratios.

(Note1) Driver mass ▶ P.54

(Note2) When load is applied at 1/3 length from output shaft edge.

Characteristics

Operating current : 1.4A/phase
Use the rubber coupling

Allowable torque Full step — Half step —
Source current (no load) Full step - - - Half step - - -
Source current (load applied) Full step ····· Half step ·····

FAF851S-CX3.6
FAF851D-CX3.6

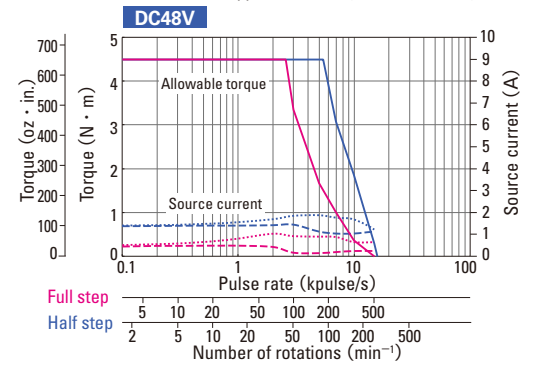
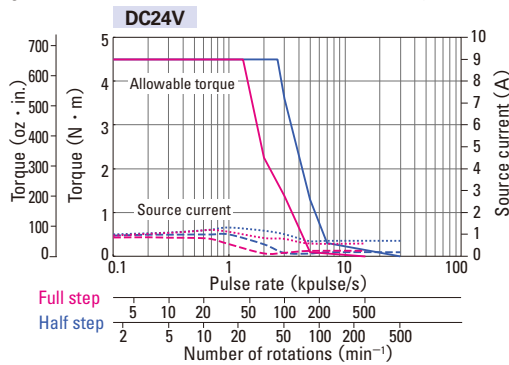

FAF851S-CX7.2
FAF851D-CX7.2

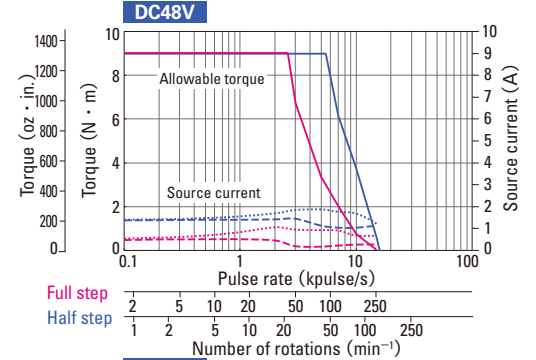
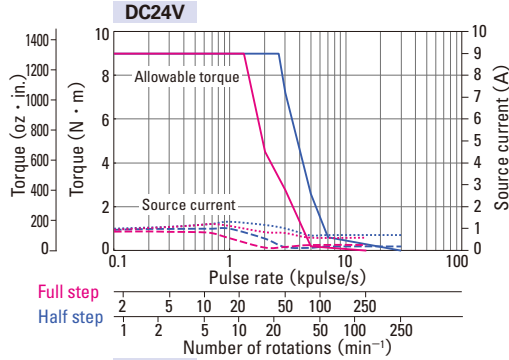

FAF851S-CX10
FAF851D-CX10

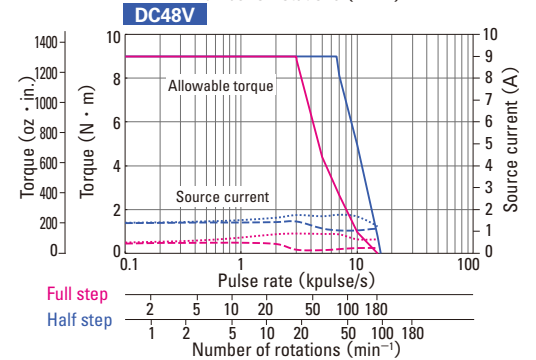
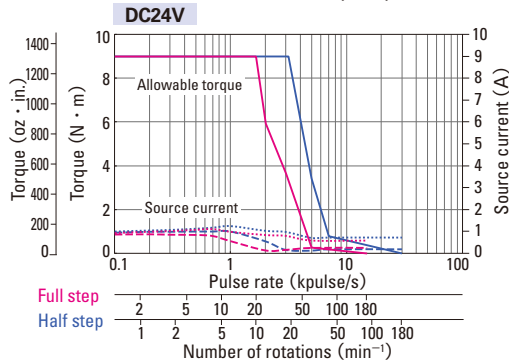

FAF851S-CX20
FAF851D-CX20

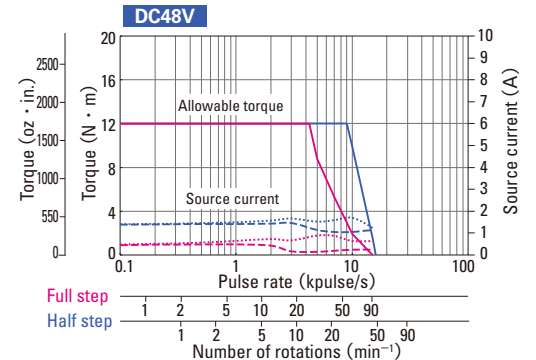
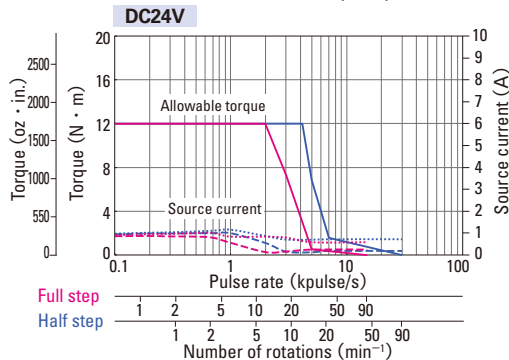

Motor size		φ86mm (φ3.39inch)	
Motor + gear length		127.3mm (5.01inch)	127.3mm (5.01inch)
Single shaft	Set ordering model no.	FAF851S-CX30	FAF851S-CX36
	Corresponding motor model number	103F8581-82CXJ4	103F8581-82CXK4
Double shaft	Set ordering model no.	FAF851D-CX30	FAF851D-CX36
	Corresponding motor model number	103F8581-82CXJ1	103F8581-82CXK1
Allowable torque	N · m (OZ · in)	12 (1699.3)	12 (1699.3)
Rotor inertia	$\times 10^{-4}$ kg · m ² (OZ · in ²)	1.45 (7.93)	1.45 (7.93)
Basic step angle	DEG	0.024	0.02
Gear ratio	-	1 : 30	1 : 36
Backlash	DEG	0.15	0.15
Allowable speed	min ⁻¹	60	50
Motor mass ^(Note1)	kg (lbs)	2.7 (5.94)	2.7 (5.94)
Allowable thrust load	N (lbs)	60 (13.5)	60 (13.5)
Allowable radial load ^(Note2)	N (lbs)	300 (67.5)	300 (67.5)

The directions of motor rotation and gear output axle rotation are the same for models with reduction ratio 1:3.6 and 1:7.2 reduction ratios, and opposite for 1:10, 1:20, 1:30 and 1:36 reduction ratios.
 (Note1) Driver mass ▶ P.54
 (Note2) When load is applied at 1/3 length from output shaft edge.

Characteristics

Operating current : 1.4A/phase
 Use the rubber coupling

FAF851S-CX30
FAF851D-CX30

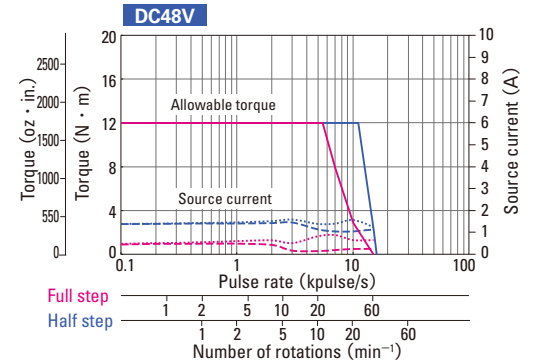
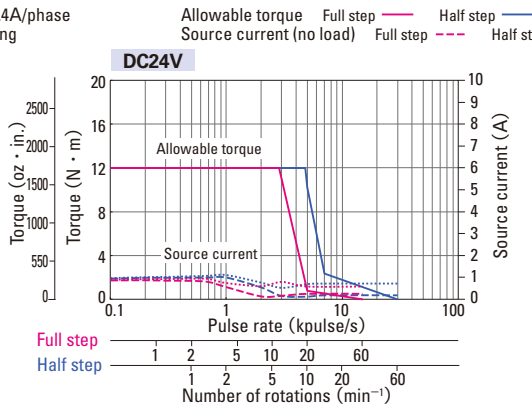

FAF851S-CX36
FAF851D-CX36

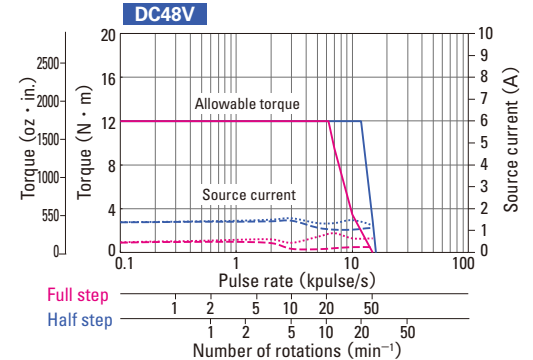
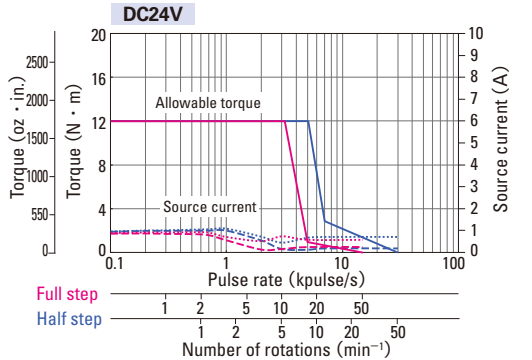

Spur gear model DC input Driver (Model number : F5PAE140P100) + Motor with spur gear

Rated current : 0.75A/phase

Motor size		28mm sq. (1.10inch sq.)			
Motor + gear length		61.5mm (2.42inch)	61.5mm (2.42inch)	61.5mm (2.42inch)	61.5mm (2.42inch)
Single shaft	Set ordering model no.	FAF521S-GX3.6	FAF521S-GX7.2	FAF521S-GX10	FAF521S-GX20
	Corresponding motor model number	SH5281-72GXA4	SH5281-72GXB4	SH5281-72GXE4	SH5281-72GXG4
Double shaft	Set ordering model no.	FAF521D-GX3.6	FAF521D-GX7.2	FAF521D-GX10	FAF521D-GX20
	Corresponding motor model number	SH5281-72GXA1	SH5281-72GXB1	SH5281-72GXE1	SH5281-72GXG1
Allowable torque	N · m (OZ · in)	0.1 (14.16)	0.15 (21.24)	0.2 (28.32)	0.35 (49.6)
Rotor inertia	$\times 10^{-4}$ kg · m ² (OZ · in ²)	0.01 (0.05)	0.01 (0.05)	0.01 (0.05)	0.01 (0.05)
Basic step angle	DEG	0.2	0.1	0.072	0.036
Gear ratio	-	1 : 3.6	1 : 7.2	1 : 10	1 : 20
Backlash	DEG	2	2	2	1.5
Allowable speed	min ⁻¹	800	400	300	150
Motor mass ^(Note1)	kg (lbs)	0.17 (0.37)	0.17 (0.37)	0.17 (0.37)	0.17 (0.37)
Allowable thrust load	N (lbs)	10 (2.25)	10 (2.25)	10 (2.25)	10 (2.25)
Allowable radial load ^(Note2)	N (lbs)	15 (3.38)	15 (3.38)	15 (3.38)	15 (3.38)

The directions of motor rotation and gear output axle rotation are the same for models with reduction ratio 1:3.6, 1:7.2, 1:20, 1:30 and 1:50 reduction ratios, and opposite for 1:10 reduction ratios.

(Note1) Driver mass ▶ P.54

(Note2) When load is applied at 1/3 length from output shaft edge.

Characteristics

Operating current : 0.75A/phase
Use the rubber coupling

Allowable torque Full step — Half step —
Source current (no load) Full step - - - Half step - - -
Source current (load applied) Full step ····· Half step ·····

FAF521S-GX3.6
FAF521D-GX3.6

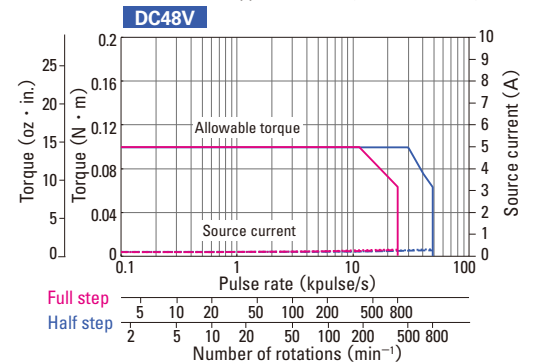
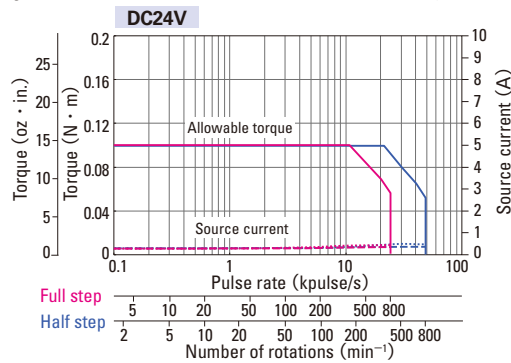

FAF521S-GX7.2
FAF521D-GX7.2

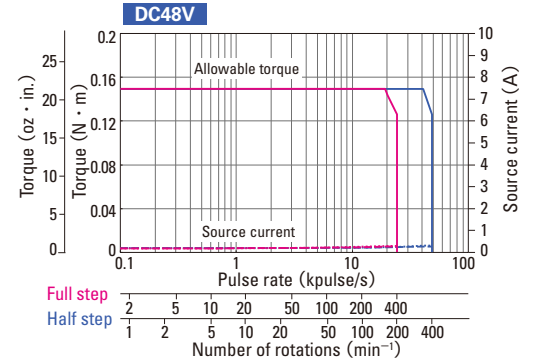
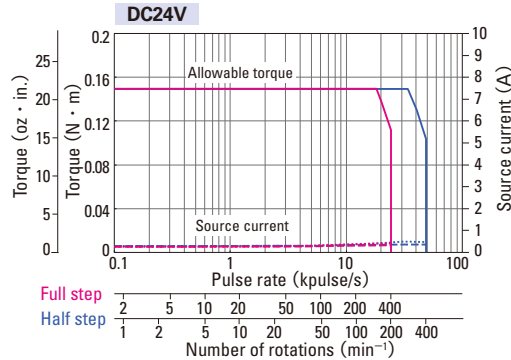

FAF521S-GX10
FAF521D-GX10

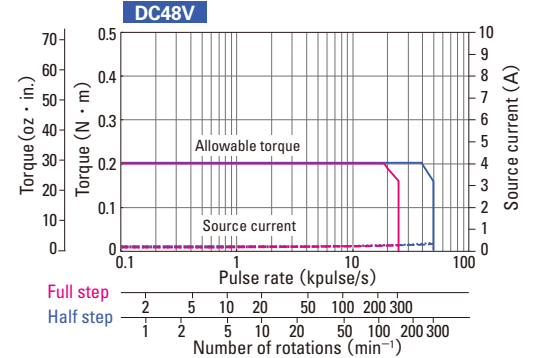
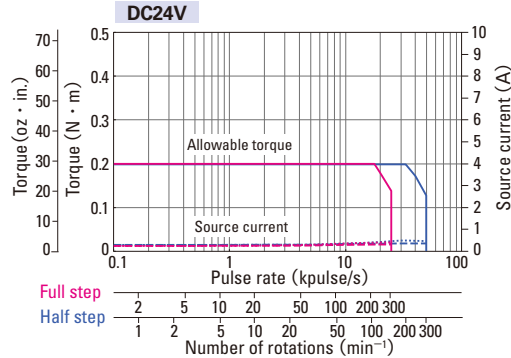

FAF521S-GX20
FAF521D-GX20

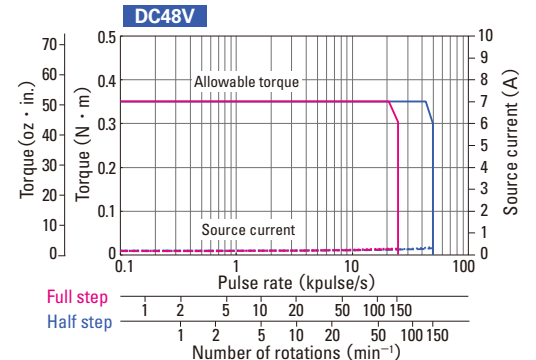
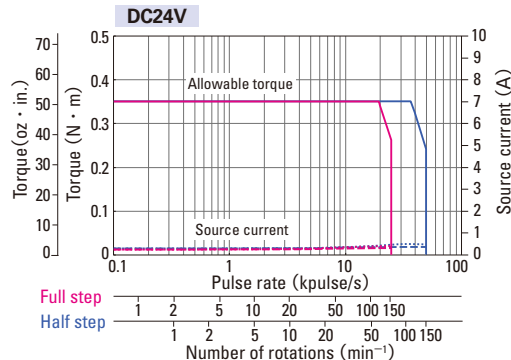

In motor+gear models, the gears may be damaged if allowable torque is exceeded. When selecting a motor, ensure that its allowable torque will not be exceeded. System configuration ▶ P.34 Set Model Configuration ▶ P.36 Motor dimensions ▶ P.102 Driver dimensions ▶ P.105 The data are measured under the drive condition of our company. The drive torque may very depending on the accuracy of customer-side equipment.

Motor size		28mm sq. (1.10inch sq.)	
Motor + gear length		61.5mm (2.42inch)	61.5mm (2.42inch)
Single shaft	Set ordering model no.	FAF521S-GX30	FAF521S-GX50
	Corresponding motor model number	SH5281-72GXJ4	SH5281-72GXL4
Double shaft	Set ordering model no.	FAF521D-GX30	FAF521D-GX50
	Corresponding motor model number	SH5281-72GXJ1	SH5281-72GXL1
Allowable torque	N · m (OZ · in)	0.5 (70.80)	0.5 (70.80)
Rotor inertia	$\times 10^{-4}$ kg · m ² (OZ · in ²)	0.01 (0.05)	0.01 (0.05)
Basic step angle	DEG	0.024	0.0144
Gear ratio	-	1 : 30	1 : 50
Backlash	DEG	1.5	1.5
Allowable speed	min ⁻¹	100	60
Motor mass ^(Note1)	kg (lbs)	0.17 (0.37)	0.17 (0.37)
Allowable thrust load	N (lbs)	10 (2.25)	10 (2.25)
Allowable radial load ^(Note2)	N (lbs)	15 (3.38)	15 (3.38)

The directions of motor rotation and gear output axle rotation are the same for models with reduction ratio 1:3.6, 1:7.2, 1:20, 1:30 and 1:50 reduction ratios, and opposite for 1:10 reduction ratios.
 (Note1) Driver mass ▶ P.54
 (Note2) When load is applied at 1/3 length from output shaft edge.

Characteristics

Operating current : 0.75A/phase
 Use the rubber coupling

Allowable torque Full step — Half step —
 Source current (no load) Full step - - - Half step - - -

Source current (load applied) Full step ····· Half step ·····

FAF521S-GX30
FAF521D-GX30

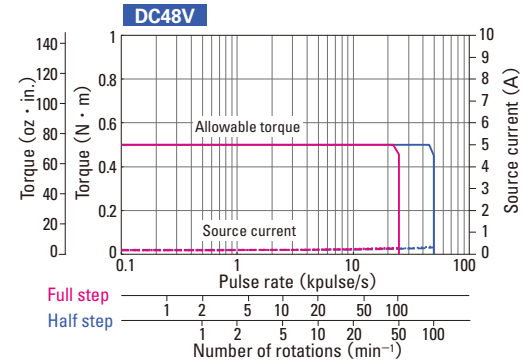
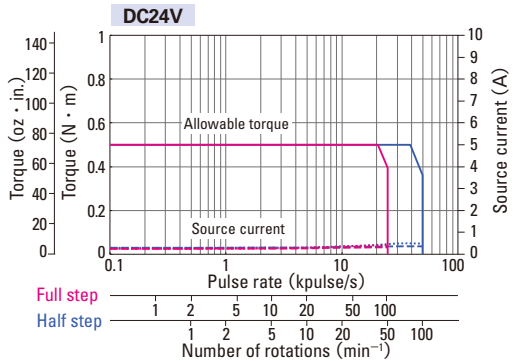

FAF521S-GX50
FAF521D-GX50

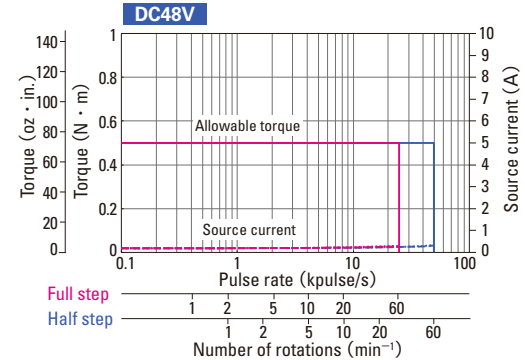
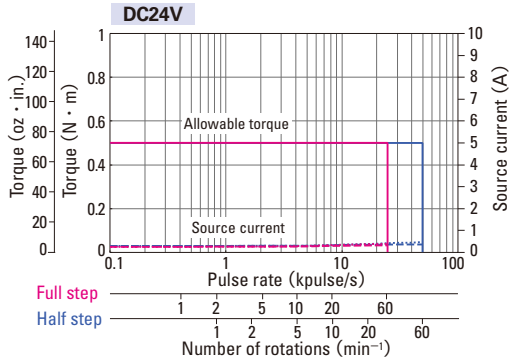

Harmonic gear model DC input Driver (Model number : F5PAE140P100) + Harmonic gear motor

Rated current : 28mm sq. (1.10inch sq.) Motor 0.75A/phase, 42mm sq. (1.65inch sq.) to ^o86mm(^o3.39inch) Motor 1.4A/phase

Motor size		28mm sq. (1.10inch sq.)		42mm sq. (1.65inch sq.)	
Motor + gear length		70.7mm (2.78inch)	70.7mm (2.78inch)	73.5 mm (2.89inch)	73.5 mm (2.89inch)
Single shaft	Set ordering model no.	FAF521S-HX50	FAF521S-HX100	FAF551S-HX30	FAF551S-HX50
	Corresponding motor model number	SH5281-72HXL4	SH5281-72HXM4	103F5505-82HXJ5	103F5505-82HXL5
Double shaft	Set ordering model no.	FAF521D-HX50	FAF521D-HX100	FAF551D-HX30	FAF551D-HX50
	Corresponding motor model number	SH5281-72HXL1	SH5281-72HXM1	103F5505-82HXJ2	103F5505-82HXL2
Allowable torque	N · m (OZ · in)	1.5 (212.4)	2 (283.2)	2.2 (311.547)	3.5 (495.643)
Momentary allowable torque	N · m (OZ · in)	2.6 (368.2)	3.6 (509.8)	4.5 (637.3)	8.3 (1175.4)
Rotor inertia	$\times 10^{-4}$ kg · m ² (OZ · in ²)	0.013 (0.066)	0.013 (0.066)	0.042 (0.23)	0.042 (0.23)
Basic step angle	DEG	0.0144	0.0072	0.024	0.0144
Gear ratio	-	1 : 50	1 : 100	1 : 30	1 : 50
Hysteresis loss	Minute	-	-	3.6	2.4
Lost motion	Minute	0.4 to 3 (± 0.06 N · m) (0.85oz · in)	0.4 to 3 (± 0.08 N · m) (1.133oz · in)	-	-
Allowable speed	min ⁻¹	70	35	116	70
Motor mass ^(Note1)	kg (lbs)	0.22 (0.48)	0.22 (0.48)	0.43 (0.94)	0.43 (0.94)
Allowable thrust load	N (lbs)	100 (22.5)	100 (22.5)	1150 (258.75)	1150 (258.75)
Allowable radial load ^(Note2)	N (lbs)	160 (36)	160 (36)	275 (61.88)	275 (61.88)

Direction of gear output shaft are the opposite.

(Note1) Driver mass ▶ P.54

(Note2) When load is applied at 1/3 length from shaft edge.

Characteristics

Use the rubber coupling

FAF521S-HX50 FAF521D-HX50

Operating current : 0.75A/phase

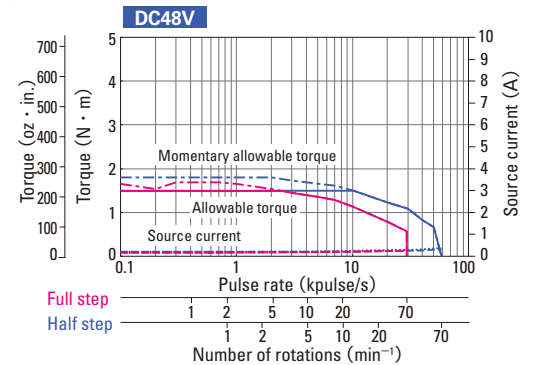
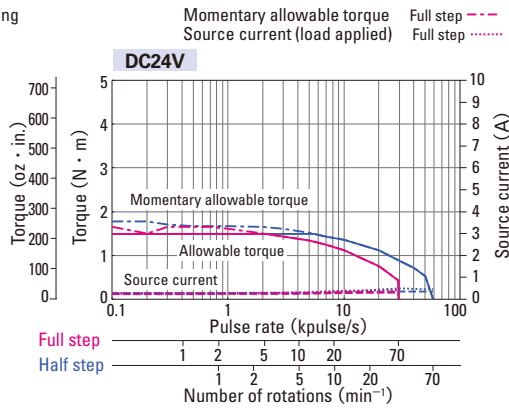

FAF521S-HX100 FAF521D-HX100

Operating current : 0.75A/phase

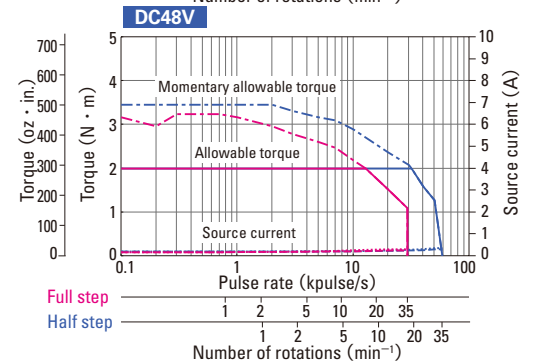
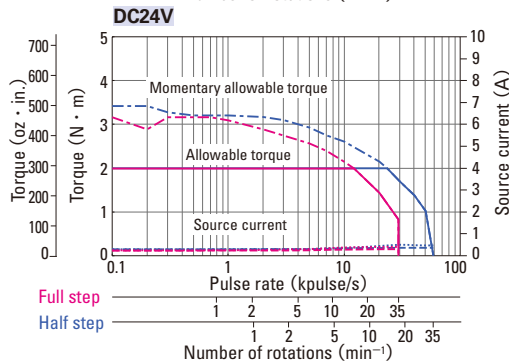

FAF551S-HX30 FAF551D-HX30

Operating current : 1.4A/phase

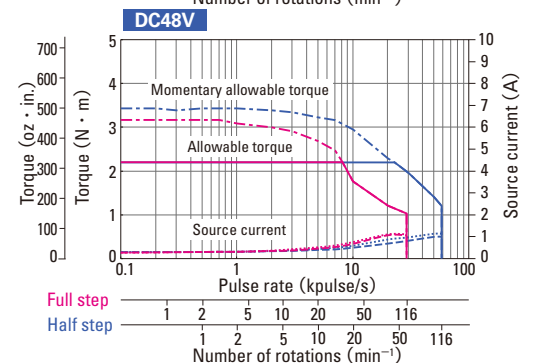
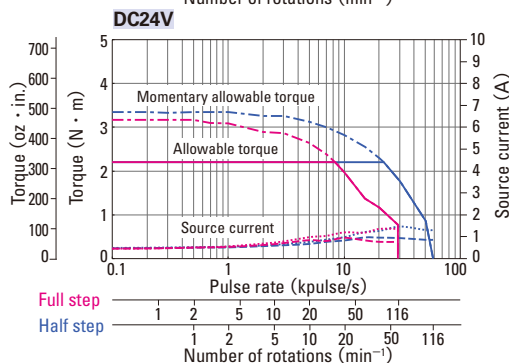

FAF551S-HX50 FAF551D-HX50

Operating current : 1.4A/phase

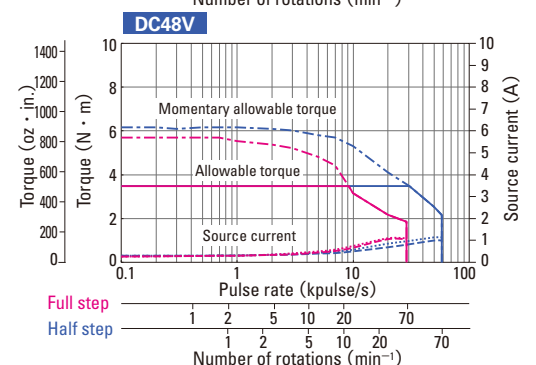
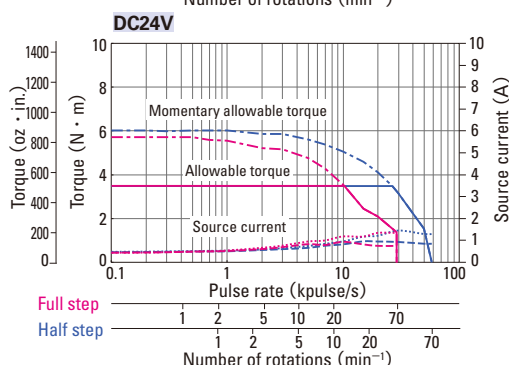

In motor+gear models, the gears may be damaged if allowable torque is exceeded. When selecting a motor, ensure that its momentary allowable torque will not be exceeded. System configuration ▶ P.34 Set Model Configuration ▶ P.36 Motor dimensions ▶ P.102 to 103 Driver dimensions ▶ P.105 The data are measured under the drive condition of our company. The drive torque may vary depending on the accuracy of customer-side equipment.

Motor size		42mm sq. (1.65inch sq.)	60mm sq. (2.36inch sq.)		φ86mm (φ3.39inch)
Motor + gear length		73.5 mm (2.89inch)	113.5mm (4.47inch)	113.5mm (4.47inch)	144.15mm (5.68inch)
Single shaft	Set ordering model no.	FAF551S-HX100	FAF781S-HX50	FAF781S-HX100	FAF851S-HX50
	Corresponding motor model number	103F5505-82HXM5	103F7851-82HXL4	103F7851-82HXM4	103F8581-82HXL4
Double shaft	Set ordering model no.	FAF551D-HX100	FAF781D-HX50	FAF781D-HX100	FAF851D-HX50
	Corresponding motor model number	103F5505-82HXM2	103F7851-82HXL1	103F7851-82HXM1	103F8581-82HXL1
Allowable torque	N · m (OZ · in)	5 (708.061)	5.5 (778.8)	8 (1132.9)	25 (3540.2)
Momentary allowable torque	N · m (OZ · in)	11 (1557.7)	14 (1982.6)	20 (2832.2)	34 (4814.8)
Rotor inertia	× 10 ⁻⁴ kg · m ² (OZ · in ²)	0.0042 (0.02)	0.31 (1.695)	0.31 (1.695)	1.65 (9.02)
Basic step angle	DEG	0.0072	0.0144	0.0072	0.0144
Gear ratio	-	1 : 100	1 : 50	1 : 100	1 : 50
Hysteresis loss	Minute	2.4	-	-	-
Lost motion	Minute	-	0.4 to 3 (± 0.28N · m) (3.965oz · in)	0.4 to 3 (± 0.4N · m) (56.645oz · in)	0.4 to 3 (± 1N · m) (141.612oz · in)
Allowable speed	min ⁻¹	35	70	35	70
Motor mass ^(Note1)	kg (lbs)	0.43 (0.92)	1.2 (2.64)	1.2 (2.64)	3.3 (7.26)
Allowable thrust load	N (lbs)	1150 (258.75)	400 (90)	400 (90)	1400 (315)
Allowable radial load ^(Note2)	N (lbs)	275 (61.88)	360 (81)	360 (81)	1380 (310.5)

Direction of gear output shaft are the opposite. (Note1) Driver mass ▶ P.54 (Note2) When load is applied at 1/3 length from shaft edge.

Characteristics

Operating current : 1.4A/phase
Use the rubber coupling

FAF551S-HX100
FAF551D-HX100

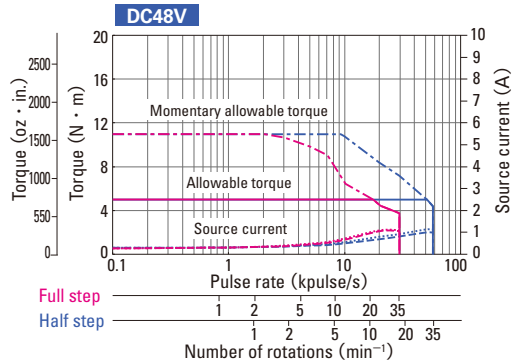
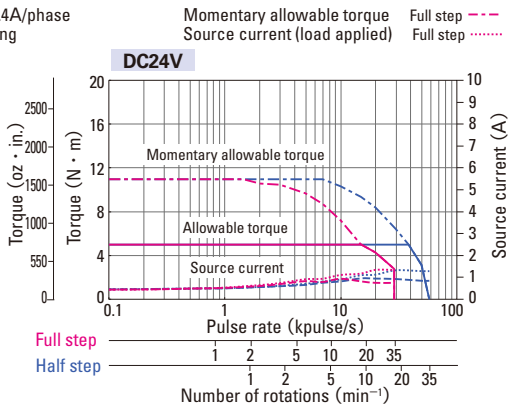

FAF781S-HX50
FAF781D-HX50

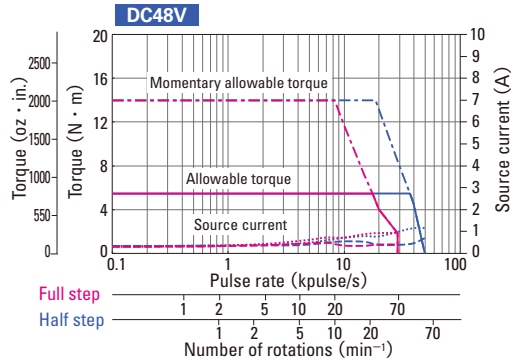
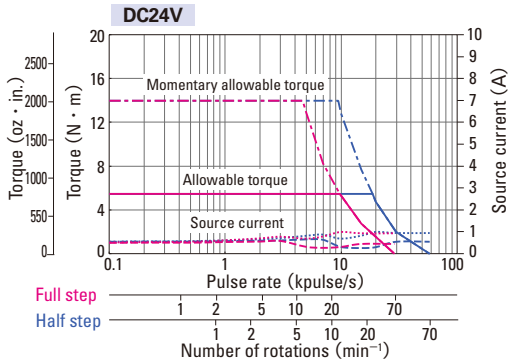

FAF781S-HX100
FAF781D-HX100

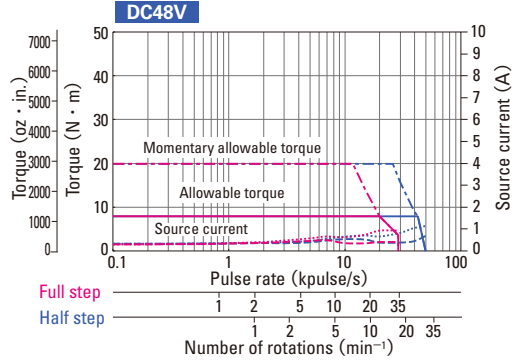
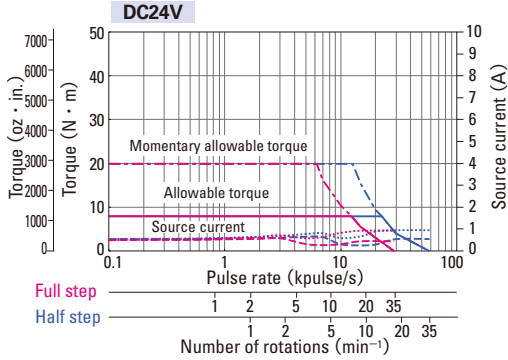

FAF851S-HX50
FAF851D-HX50

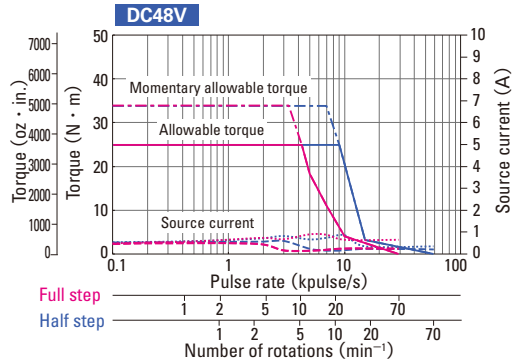
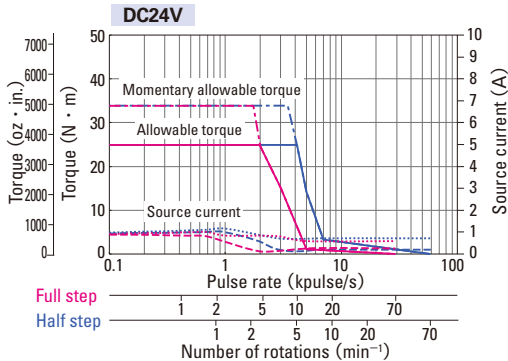

In motor+gear models, the gears may be damaged if allowable torque is exceeded. When selecting a motor, ensure that its momentary allowable torque will not be exceeded. System configuration ▶ P.34 Set Model Configuration ▶ P.36 Motor dimensions ▶ P.102 to 103 Driver dimensions ▶ P.105 The data are measured under the drive condition of our company. The drive torque may very depending on the accuracy of customer-side equipment.

Harmonic gear model DC input Driver (Model number : F5PAE140P100) + Harmonic gear motor

Rated current : 28mm sq. (1.10inch sq.) Motor 0.75A/phase, 42mm sq. (1.65inch sq.) to ϕ 86mm(ϕ 3.39inch) Motor 1.4A/phase

Motor size	ϕ86mm (ϕ3.39inch)	
Motor + gear length	144.15mm (5.68inch)	
Single shaft	Set ordering model no.	FAF851S-HX100
	Corresponding motor model number	103F8581-82HXM4
Double shaft	Set ordering model no.	FAF851D-HX100
	Corresponding motor model number	103F8581-82HXM1
Allowable torque	N · m (OZ · in)	41 (5805.9)
Momentary allowable torque	N · m (OZ · in)	59 (8355.1)
Rotor inertia	$\times 10^{-4}$ kg · m ² (OZ · in ²)	1.65 (9.02)
Basic step angle	DEG	0.0072
Gear ratio	-	1 : 100
Hysteresis loss	Minute	-
Lost motion	Minute	0.4 to 3 (± 1.2N · m) (169.934oz · in)
Allowable speed	min ⁻¹	35
Motor mass ^(Note1)	kg (lbs)	3.3 (7.26)
Allowable thrust load	N (lbs)	1400 (315)
Allowable radial load ^(Note2)	N (lbs)	1380 (310.5)

Direction of gear output shaft are the opposite.

(Note1) Driver mass ▶ P.54

(Note2) When load is applied at 1/3 length from shaft edge.

Characteristics

Operating current : 1.4A/phase
Use the rubber coupling

FAF851S-HX100
FAF851D-HX100

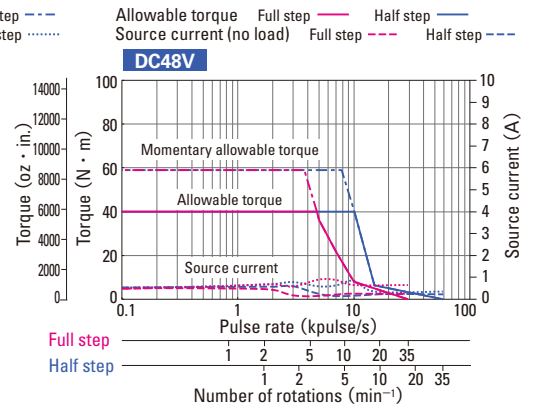
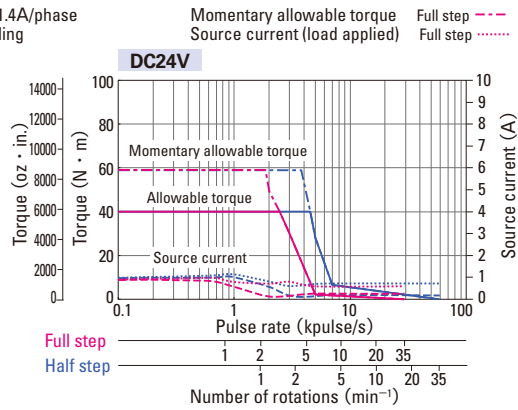

Electromagnetic brake model

DC input Driver (Model number : F5PAE140P100) + Electromagnetic brake motor

Basic step angle : 0.72° Rated current : 1.4A/phase

Motor size		42mm sq. (1.65inch sq.)			60mm sq. (2.36inch sq.)
Motor length		64.5mm (2.54inch)	70.5mm (2.78inch)	79.5mm (3.13inch)	85.8mm (3.38inch)
Set ordering model no.		FAF551S-XB	FAF552S-XB	FAF554S-XB	FAF781S-XB
Corresponding motor model number		103F5505-82XB41	103F5508-82XB41	103F5510-82XB41	103F7851-82XB41
Holding torque	N · m (OZ · in)	0.13 (8.4)	0.18 (25.49)	0.25 (35.4)	0.55 (77.9)
Rotor inertia	$\times 10^{-4}$ kg · m ² (OZ · in ²)	0.045 (0.25)	0.068 (0.37)	0.08 (0.44)	0.43 (2.35)
Motor mass ^(Note1)	kg (lbs)	0.38 (0.84)	0.43 (0.95)	0.52 (1.14)	0.94 (2.07)
Allowable thrust load	N (lbs)	10 (2.25)	10 (2.25)	10 (2.25)	20 (4.5)
Allowable radial load ^(Note2)	N (lbs)	35 (8.75)	35 (8.75)	35 (8.75)	80 (18)
Brake type		No excitation actuating type		No excitation actuating type	
Electromagnetic brake	Power supply input	DC24V \pm 5%		DC24V \pm 5%	
	Excitation current	0.08		0.08	
	Power consumption	2		2	
	Static friction torque	0.3 (42.48)		0.3 (42.48)	
	Brake operating time	20		20	
	Brake release time	30		30	

(Note1) Driver mass ▶ P.54

(Note2) When load is applied at 1/3 length from output shaft edge.

Characteristics

Operating current : 1.4A/phase
Use the rubber coupling

Pull-out torque Full step — Half step — fs : Maximum self-start frequency when not loaded
Source current (no load) Full step - - - Half step - - - Source current (load applied) Full step ● Half step ●

FAF551S-XB

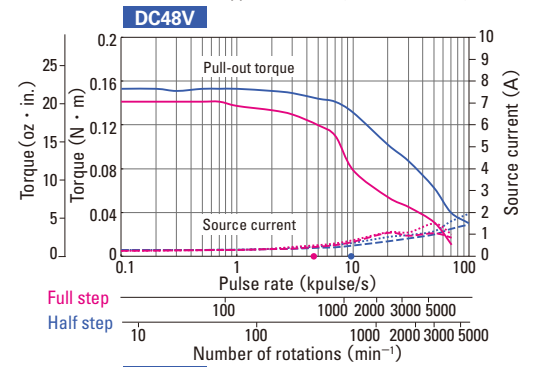
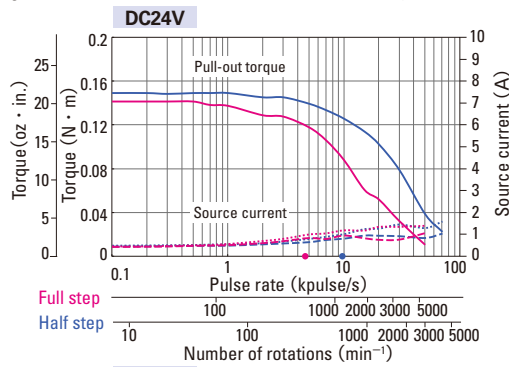

FAF552S-XB

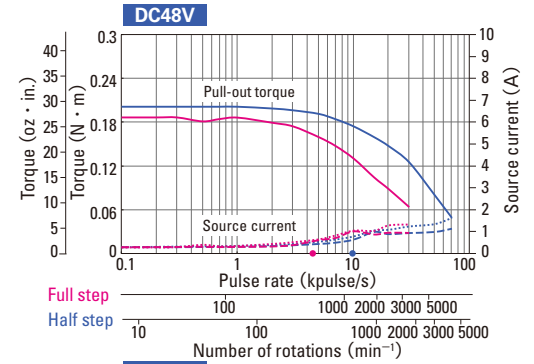
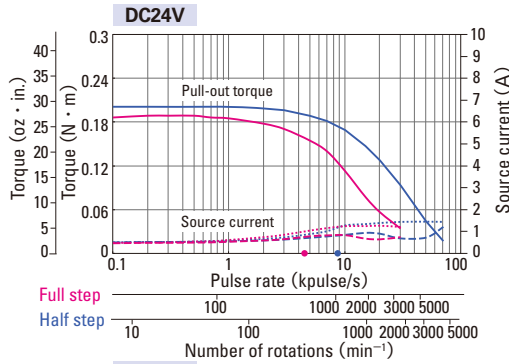

FAF554S-XB

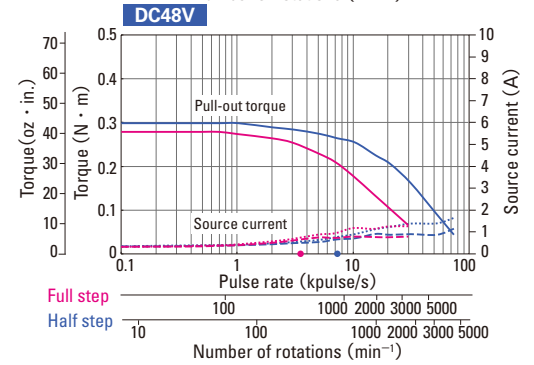
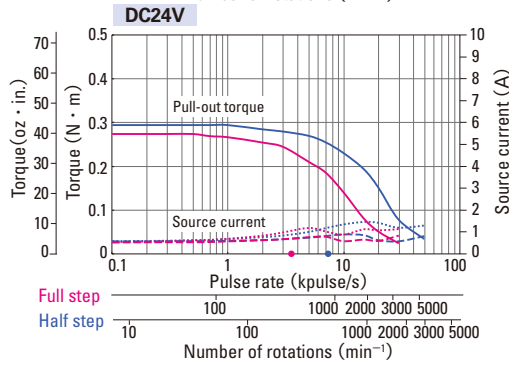

FAF781S-XB

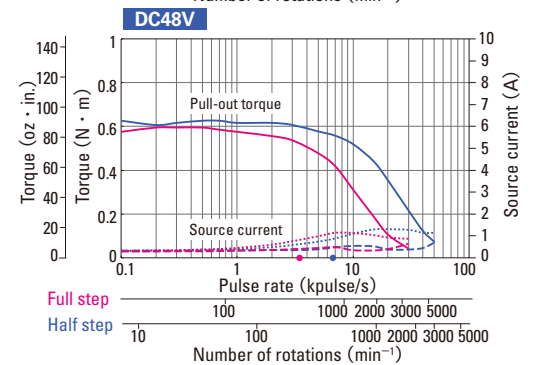
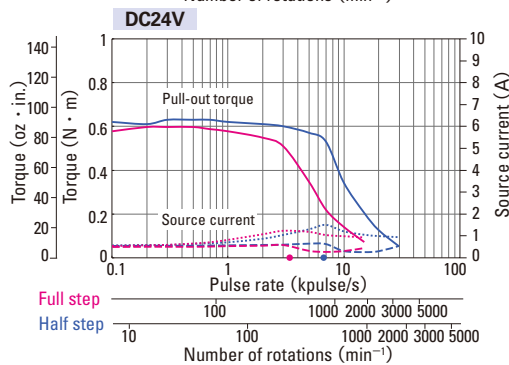

The electromagnetic brake only works when the motor is stopped, and cannot be used for braking. System configuration ▶ P.34 Set Model Configuration ▶ P.36 Motor dimensions ▶ P.104 Driver dimensions ▶ P.105 The data are measured under the drive condition of our company. The drive torque may very depending on the accuracy of customer-side equipment.

AC input Set model
Micro step

DC input Set model
Micro step

DC input Set model
Full / half step

Stepping Motor

Linear Actuator
Stepping Motor

Stepping motor for
vacuum environment

Dimensions

Electromagnetic brake model

DC input Driver (Model number : F5PAE140P100) + Electromagnetic brake motor

Basic step angle : 0.72° Rated current : 1.4A/phase

Motor size		60mm sq. (2.36inch sq.)		φ86mm (φ3.39inch)	
		94.5mm (3.72inch)	126.7mm (4.99inch)	116.7mm (4.59inch)	146.8mm (5.78inch)
Set ordering model no.		FAF782S-XB	FAF783S-XB	FAF851S-XB	FAF852S-XB
Corresponding motor model number		103F7852-82XB41	103F7853-82XB41	103F8581-82XB41	103F8582-82XB41
Holding torque	N · m (OZ · in)	0.87 (123.2)	1.67 (236.5)	2 (283.2)	4.02 (569.3)
Rotor inertia	$\times 10^{-4} \text{kg} \cdot \text{m}^2 (\text{OZ} \cdot \text{in}^2)$	0.56 (3.06)	1 (5.47)	2.24 (12.25)	3.69 (20.18)
Motor mass ^(Note1)	kg (lbs)	1.12 (2.46)	1.7 (3.74)	3.5 (7.7)	4.5 (9.9)
Allowable thrust load	N (lbs)	20 (4.5)	20 (4.5)	60 (13.5)	60 (13.5)
Allowable radial load ^(Note2)	N (lbs)	80 (18)	80 (18)	220 (49.5)	220 (49.5)
Brake type		No excitation actuating type		No excitation actuating type	
Electromagnetic brake	Power supply input	DC24V \pm 5%		DC24V \pm 5%	
	Excitation current	0.25		0.25	
	Power consumption	6		6	
	Static friction torque	0.8 (113.29)		0.8 (113.29)	
	Brake operating time	20		20	
	Brake release time	30		30	

(Note1) Driver mass ▶ P.54

(Note2) When load is applied at 1/3 length from output shaft edge.

Characteristics

Operating current : 1.4A/phase
Use the rubber coupling

Pull-out torque Full step — Half step — fs : Maximum self-start frequency when not loaded
Source current (no load) Full step - - - Half step - - - Source current (load applied) Full step ● Half step ●

FAF782S-XB

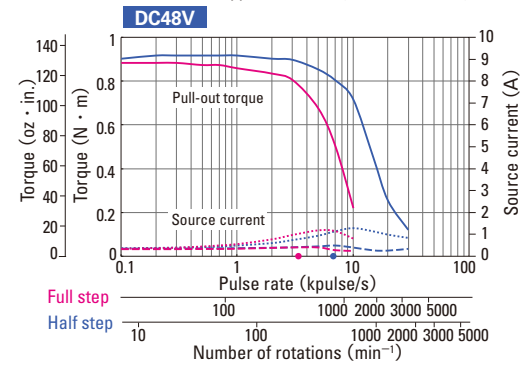
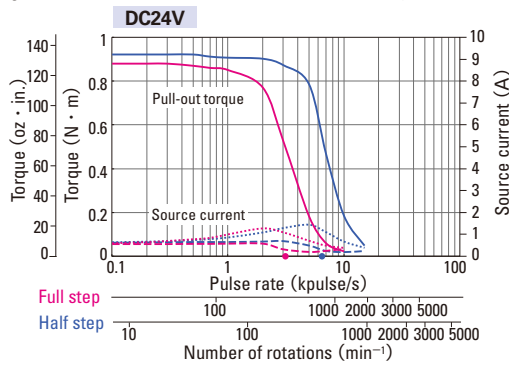

FAF783S-XB

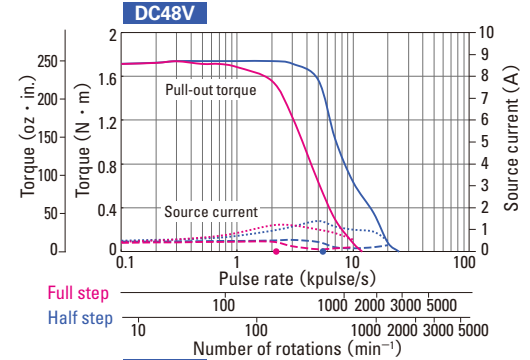
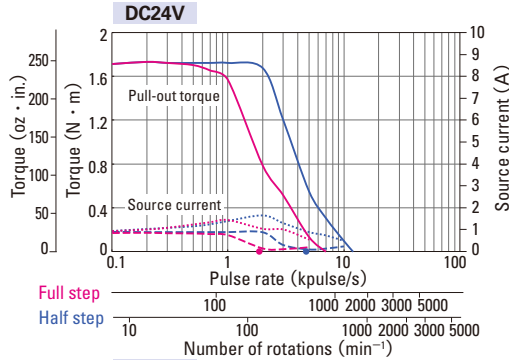

FAF851S-XB

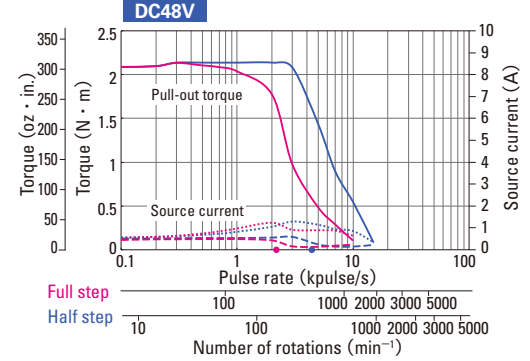
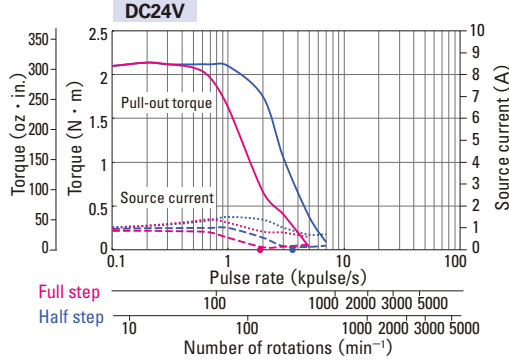

FAF852S-XB

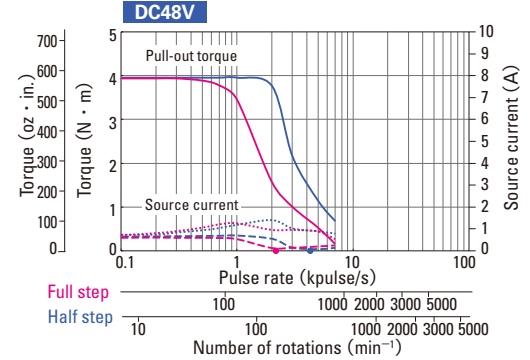
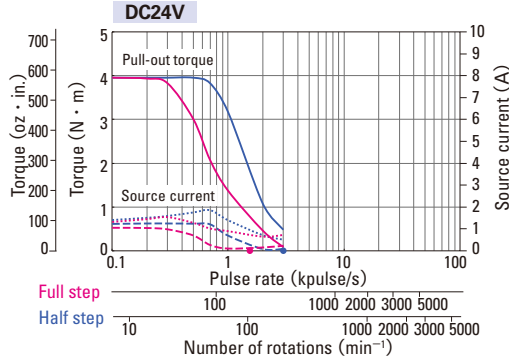

Motor specifications

General specifications

Model number	SH528 □	103F55 □□ / 103F785 □ / 103F858 □
Ambient operation temperature	- 10 to + 50°C (0 to + 40°C for harmonic gear model)	
Storage temperature	- 20 to + 65°C	
Ambient operation humidity	20 to 90% RH (no condensation)	
Storage humidity	5 to 95% RH (no condensation)	
Operation altitude	1000 m (3280 feet) MAX. above sea level	
Vibration resistance	Vibration frequency 10 to 500 Hz, total amplitude 1.52 mm (10 to 70 Hz), vibration acceleration 147 m/s ² (70 to 500 Hz), sweep time 15 min/cycle, 12 sweeps in each X, Y and Z direction.	
Impact resistance	490m/s ² of acceleration for 11 ms with half-sine wave applying three times for X, Y, and Z axes each, 18 times in total.	
Insulation class	Class B (+ 130°C)	
Withstand voltage	At normal temperature and humidity, no failure with 500 V AC @50/60 Hz applied for one minute between motor winding and frame.	At normal ambient temperature and humidity, no failure with 1500 V AC @50/60 Hz applied for one minute between motor winding and frame.
Insulation resistance	At normal ambient temperature and humidity, 100 Mohm or more on megger with 500 V DC between motor winding and frame.	
Protection grade	IP40	
Wiring temperature increase	80K MAX. (Based on Sanyo Denki standard)	
Axial play ^(Note1)	0.075mm (0.002952inch) MAX., Load 4.4N (1lbs)	0.075mm (0.002952inch) MAX., Load 9N (2lbs)
Radial play ^(Note2)	0.025mm (0.00098inch) MAX., Load 4.4N (1lbs)	
Shaft runout	0.025mm	
Inserted part concentricity against shaft	φ 0.05mm	φ 0.075mm
Fitted surface angularity against shaft	0.1mm	0.1mm

(Note1) Axial play: Shaft displacement under axial load.

(Note2) Radial play: Shaft displacement under radial load applied 1/3rd of the length from the end of the shaft.

Internal wire connection

Connection Method: New Pentagon

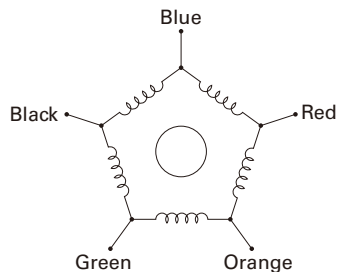

Direction of motor rotate

The direction of motor rotate is clockwise when viewed from the output shaft side at the direct current energization in the following order.

※ This is an instance of the standard model and the electromagnetic brake model.

As for some of the models with the gear, the direction of motor rotation is different, please make inquiries.

		Exciting order									
		1	2	3	4	5	6	7	8	9	10
Color of leads	Blue			+	+	+			-	-	-
	Red	-	-			+	+	+			-
	Orange		-	-	-			+	+	+	
	Green	+			-	-	-			+	+
	Black	+	+	+			-	-	-		

Driver specifications

General specifications

Basic specifications	Model number	F5PAE140P100	
	Main circuit power	DC24V/48V \pm 10% (Note1)	
	Main circuit power supply current	3A	
	Environment	Protection class	Class III
		Operation environment	Installation category (over-voltage category) : I (CE) Pollution level : 2
		Ambient operation temperature	0 to + 50°C
		Storage temperature	- 20 to + 70°C
		Ambient operation humidity	35 to 85%RH (no condensation)
		Storage humidity	10 to 90%RH (no condensation)
		Operation altitude	1000 m (3280 feet) MAX. above sea level
		Vibration resistance	Tested under the following conditions ; 5m/s ² , frequency range 10 to 55Hz, direction along X, Y and Z axes, for 2 hours each
		Impact resistance	20m/s ²
		Withstand voltage	Not influenced when 1500V AC is applied between power input terminal and cabinet for one minute.
	Insulation resistance	10M ohm MIN. when measured with 500V DC megohmmeter between input terminal and cabinet.	
Mass	0.23kg		
Functions	Selection function	Pulse-input method (single signal input/ simultaneous signal input), low-vibration drive/ micro-step drive), resolution (2-phase mode/ 5-phase mode), output signal (phase origin monitor/ alarm), operating current, step-angle	
	Protection functions	Overcurrent protection	
	LED indication	Monitoring power supply, displaying alarm(main power supply under- and overvoltage, regenerative fault, overcurrent fault, hardware fault)	
I/O signals	Auto-Current-Down canceling input signal	Photo-coupler input system ; input resistance: 330 Ω ; input-signal "H" level : 4.5 to 5.5V ; input-signal "L" level : 0 to 0.5V	
	Step-angle selection input	Photo-coupler input system ; input resistance: 330 Ω ; input-signal "H" level : 4.5 to 5.5V ; input-signal "L" level : 0 to 0.5V	
	Command pulse input signal	Photocoupler-input method, input resistance: 330 Ω Input signal voltage Level H: 4.5 to 5.5V Level L: 0 to 0.5V Provided that voltage between Level H to L shall be 4.5V or over. Maximum input frequency: 400kpulse/s	
	Power down input signal	Photo-coupler input system ; input resistance: 330 Ω ; input-signal "H" level : 4.5 to 5.5V ; input-signal "L" level : 0 to 0.5V	
	Input signal/Output signal	Open collector output via photocoupler Output signal standard Vce: 30V or less (Note2) Ic: 5mA or less Vce (sat): 1.0V or less	

(Note1) Use either DC24V \pm 10% or DC48V \pm 10% for main circuit power supply. Make sure never exceed DC60V, even if power supply voltage increases due to counter-electromotive force after misstep occurs. If there are any possibilities of exceeding DC60V, connect optional regenerative resistor. Regenerative resistor use is recommended if you operate with 60mm sq. (2.36inch sq.) or ϕ 86mm (ϕ 3.39inch) motor.

(Note2) Make sure the voltage used for output signal is DC5V or over.

Safety standards

	Directives	Category	Standard part	Name
CE (TÜV)	Low-voltage directives	—	EN61800-5-1	—
	EMC directives	Emission	EN61000-6-4	Conducted emissions test
			EN61000-6-4	Electromagnetic radiation disturbance
			EN61000-4-2	ESD (Electrostatic discharge)
		Immunity	EN61000-4-3	RS (Radio-frequency amplitude modulated electromagnetic field)
			EN61000-4-4	Fast transients
			EN61000-4-5	CS (Radio-frequency common mode)
	EN61000-4-6	Surges		
UL	Acquired standards		Standard part	File No.
	UL		UL508C	E179775
	UL for Canada (c-UL)			

• EMC characteristics may vary depending on the configuration of the users' control panel, which contains the driver or stepping motor, or the arrangement and wiring of other electrical devices.

• Validation test of driver has been performed for low-voltage EMC directives at TÜV (TÜV SUD Japan) for self-declaration of CE marking.

Driver Controls and Connectors

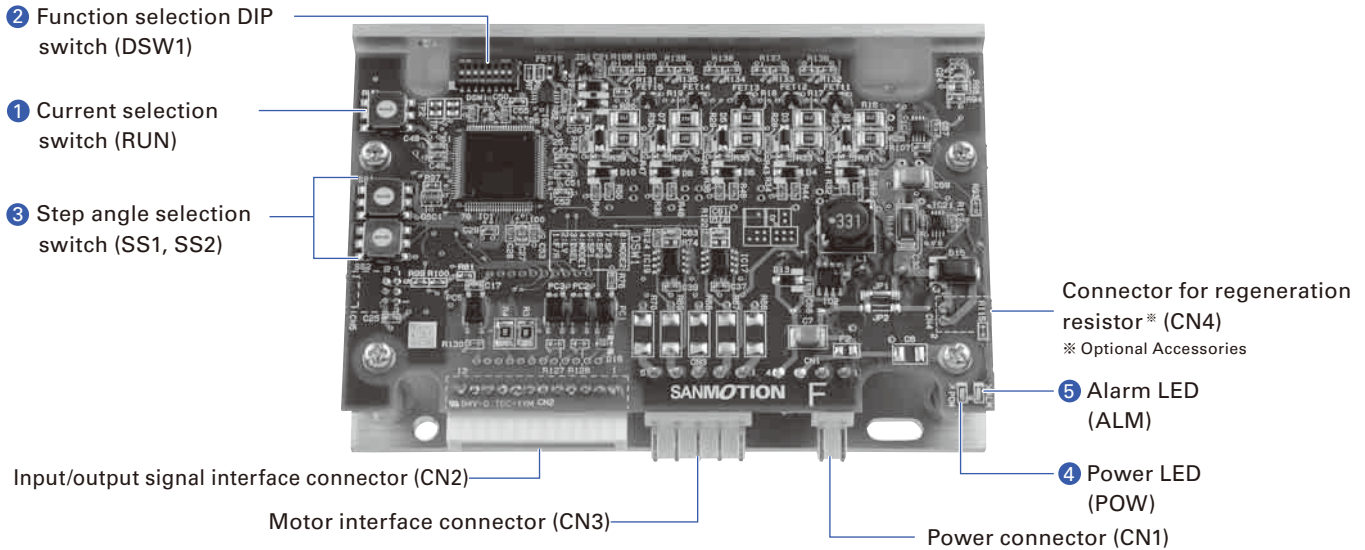

1 Current selection switch (RUN)

Rotary switch selects motor operating current.

Dial	0	1	2	3	4	5	6	7
Stepping motor current (A)	1.4	1.35	1.3	1.25	1.2	1.15	1.1	1.05
Dial	8	9	A	B	C	D	E	F
Stepping motor current (A)	1.0	0.95	0.9	0.85	0.8	0.75	0.7	0.65

- The factory default value is F(0.65A).
- Please check the rated current of the motor to be combined before selecting the operation current.
- If there are sufficient margin of motor torque, decreasing operating current value becomes effective for vibration reduction. Motor output torque is approximately proportional to current.
- Make sure to confirm there are sufficient operation margin before determining motor current value to adjust operating current.

2 Function selection DIP switch (DSW1)

Selects the function according to application method.
Factory default settings

Switch	Position	Function
F/R	ON	2-input mode (CW, CCW pulse-input method)
LV	OFF	Micro-step
DSEL	OFF	5-phase mode
MODE1	OFF	Phase origin monitor output
SP1	ON	Settings vary depending on motors to be connected. Perform setting for motor you use first by confirming the [table of setting for motors to be connected] below.
SP2	ON	
SP3	ON	
MODE2	OFF	Reservation (Don't turn it ON)

- Perform setting for motor to be connected first.
- Make sure to turn off power supply of the driver when changing settings of function selection DIP switch.

[Table of setting for motors to be connected]

SP1	SP2	SP3	Motor to be connected
OFF	OFF	OFF	SH5281-72 □□, SH5285-72 □□, 103F5505-82 □□
OFF	OFF	ON	103F5508-82 □□
OFF	ON	OFF	103F5510-82 □□
OFF	ON	ON	103F7851-82 □□
ON	OFF	OFF	103F7852-82 □□
ON	OFF	ON	103F7853-82 □□, 103F8581-82 □□
ON	ON	OFF	103F8582-82 □□

1. Pulse inputting method selection (F/R)

Pulse inputting method can be selected:

F/R	Pulse input method
ON	1 input (CK, U/D)
OFF	2 input (CW, CCW)

2. Low-vibration mode select (LV)

Provides low-vibration, smooth operation even if resolution is rough (1-division, 2-division, etc)

LV	Operation
ON	Low-vibration drive
OFF	Micro-step

3. Resolution selection (DSEL)

Mode of step-angle selection switch (SS1, SS2) can be selected:

DSEL	Resolution mode
ON	2-phase mode: Operation as normal 2-phase stepping system at 1.8° to 0.00703125° -step angle is available.
OFF	5-phase mode: Operation as normal 5-phase stepping system at 0.72° to 0.00288° -step angle is available.

4. Output signal selection (MODE1)

Output signal can be selected:

MODE1	Output signal
ON	Alarm output
OFF	Phase origin monitor output

5 to 7. Motor selection (SP1, SP2, SP3)

Perform setting for motor you use first by confirming the [table of setting for motors to be connected].

8. (MODE2)

Do not turn ON this switch.

3 Step angle selection switch (SS1, SS2)

Division number of primary step angle for stepping motor can be selected by means of this rotary switch.

After selecting 2- or 5-phase mode by function selection DIP switch 3 (DSEL), set the step angle selection switches for the desired step angle.

5-Phase Mode: DSW1 function selection DIP switch 3 = OFF				2-Phase Mode: DSW1 function selection DIP switch 3 = ON			
SS1,SS2	Number of divisions	Resolution	Basic step angle	SS1,SS2	Number of divisions	Resolution	Basic step angle
0	1	500	0.72°	0	0.4	200	1.8°
1	2	1000	0.36°	1	0.8	400	0.9°
2	2.5	1250	0.288°	2	1.6	800	0.45°
3	4	2000	0.18°	3	2	1000	0.36°
4	5	2500	0.144°	4	3.2	1600	0.225°
5	8	4000	0.09°	5	4	2000	0.18°
6	10	5000	0.072°	6	6.4	3200	0.1125°
7	20	10000	0.036°	7	10	5000	0.072°
8	25	12500	0.0288°	8	12.8	6400	0.05625°
9	40	20000	0.018°	9	20	10000	0.036°
A	50	25000	0.0144°	A	25.6	12800	0.028125°
B	80	40000	0.009°	B	40	20000	0.018°
C	100	50000	0.0072°	C	50	25000	0.0144°
D	125	62500	0.00576°	D	51.2	25600	0.0140625°
E	200	100000	0.0036°	E	100	50000	0.0072°
F	250	125000	0.00288°	F	102.4	51200	0.00703125°

- Factory default setting: SS1 = 1 and SS2 = 0
- Set the step angle selection input (DSEL) to select SS1 or SS2, then set the rotary switch.

4 Power LED (POW)

Lights when control and main circuits are energized.

5 Alarm LED (ALM)

Flashes to indicate alarm events.

Indication	Explanation
"ALM" repeats single-flashing.	Main power supply voltage drop (Detected when excitation is on.)
"ALM" repeats double-flashing.	Overvoltage of main power supply (Detected when motor stops.)
"ALM" repeats triple-flashing.	Regeneration error (Detected when motor is operating.)
"ALM" repeats quadruple-flashing.	Overcurrent error
"ALM" repeats five-times-flashing.	Hardware error

- When alarm activated, stepping motor winding current is interrupted and then the state becomes "not-excited" at the same time that LED "ALM" flashes.
- When "DSW1: MODE1" is set to ON, signal is output outward from alarm output terminal (AL). (Photocoupler is turned on.)
- This state is maintained until the power supply is turned off. Please re-turn on the power supply after eliminating alarm cause.

Connections and Signals

External wiring diagram

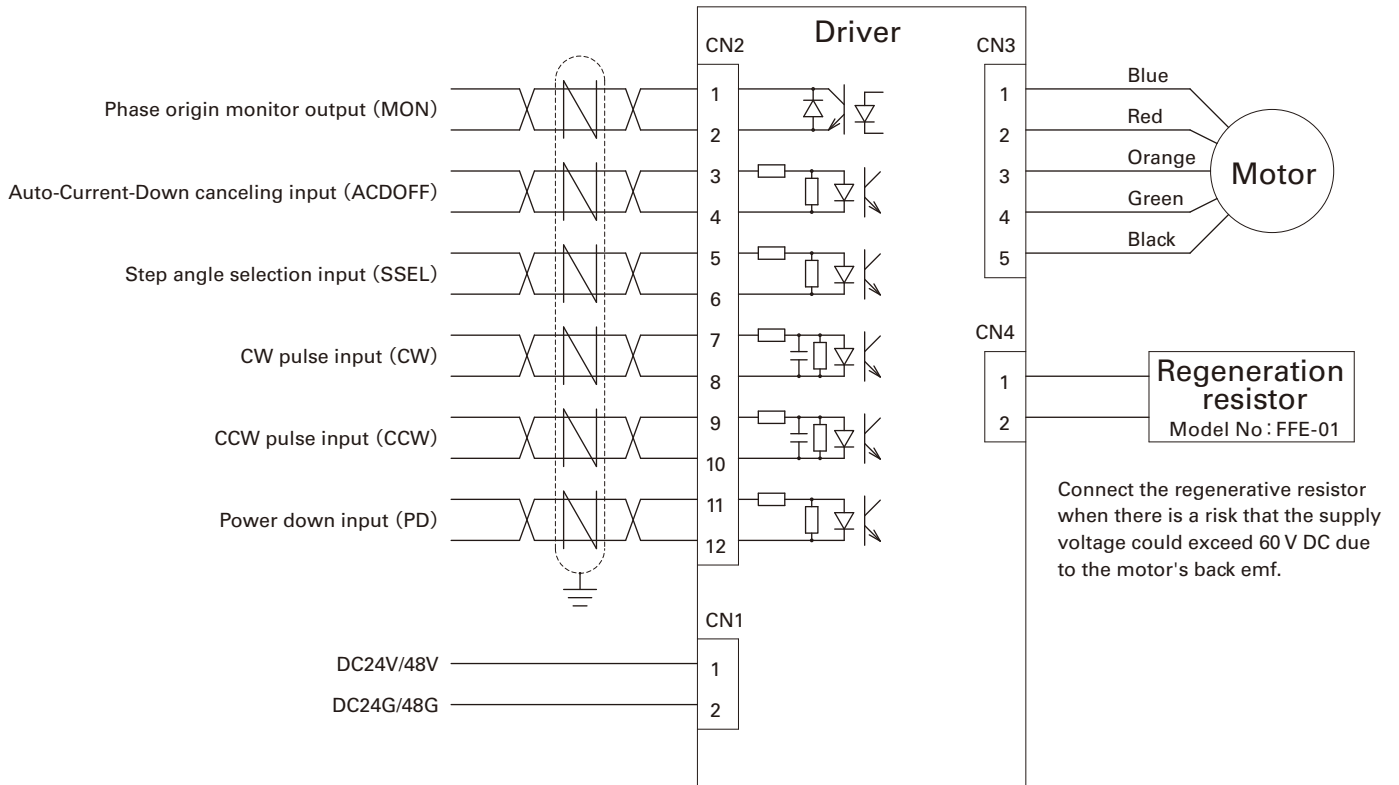

Applicable wire sizes

Part	Applicable wire	Insulation diameter	Wiring length
Power supply	AWG20 (0.5mm ²) to AWG18 (0.75mm ²)	φ 1.7 to φ 3.0mm	Less than 3m
Input/output signal	AWG24 (0.2mm ²) to AWG22 (0.3mm ²)	φ 1.15 to φ 1.8mm	Less than 3m
Motor	AWG20 (0.5mm ²) to AWG18 (0.75mm ²)	φ 1.7 to φ 3.0mm	10m max.

When bundling wire together or running wires through duct, take reduction rate of each wire allowable current into consideration. When ambient temperature is relatively high, wire product lifetime is reduced due to heat deterioration. In this case, please use Heat resistant Indoor PVC (HIV).

Specification summary of CN2 I/O signal

Signal name	CN2 Pin number	Function
Phase origin monitor output (standard)	1	DSW1 MODE1=OFF
	2	Photocoupler is turned on when excitation phase is the origin (the state power supply is turned on).
Alarm output	1	DSW1 MODE1=ON
	2	Photocoupler is turned on when the driver is in the state of alarm being activated.
Auto-Current-Down canceling input	3	Inputting this signal (internal photpcoupler is turned on) disables Auto-Current-Down function.
	4	
Step angle selection input	5	Division numbers can be switched via SSEL-signal.
	6	Internal photocoupler is OFF ... Setting via rotary switch SS1 enabled Internal photocoupler is ON ... Setting via rotary switch SS2 enabled
CW pulse input (standard)	7	When using "2-input mode"
	8	Drive pulse for the CW direction rotation is input.
Pulse column input	7	When using "Pulse and direction mode"
	8	Drive pulse train for the stepping motor rotation is input.
CCW pulse input (standard)	9	When using "2-input mode"
	10	Drive pulse for the CCW direction rotation is input.
Rotation direction input	9	The rotation direction signal of stepping motor is input for the "Pulse and direction mode".
	10	Internal photocoupler ON ... CW direction Internal photocoupler OFF ... CCW direction
Power down input	11	Inputting this signal (internal photocoupler is turned on) shuts off the current carried to motor.
	12	

The CW rotation direction of stepping motor means the clockwise direction rotation as viewed from the output shaft side (ange side).

The CCW rotation direction means the counterclockwise direction rotation as viewed from the output shaft side (ange side).

Input circuit configuration of CW (CK), CCW (U/D)

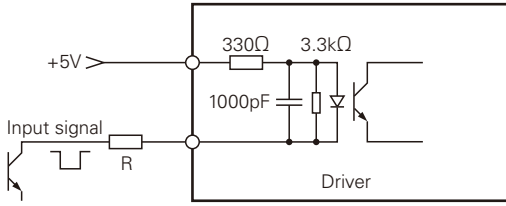

- Pulse duty 50% MAX.
- Maximum input frequency: 400kpulse/s
- When crest value of input signal exceeds 5V, add external limiting resistor R so that input current becomes approximately 10mA. (Consider photocoupler forward voltage: 1.5V)

Input signal specification

(Photo coupler)

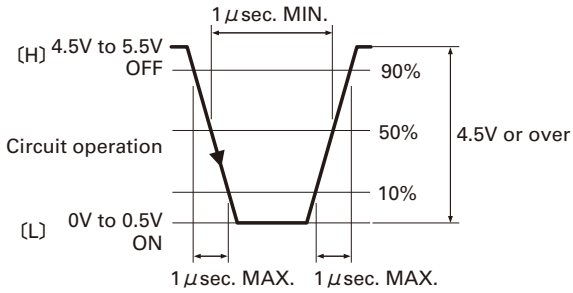

Timing of command pulse

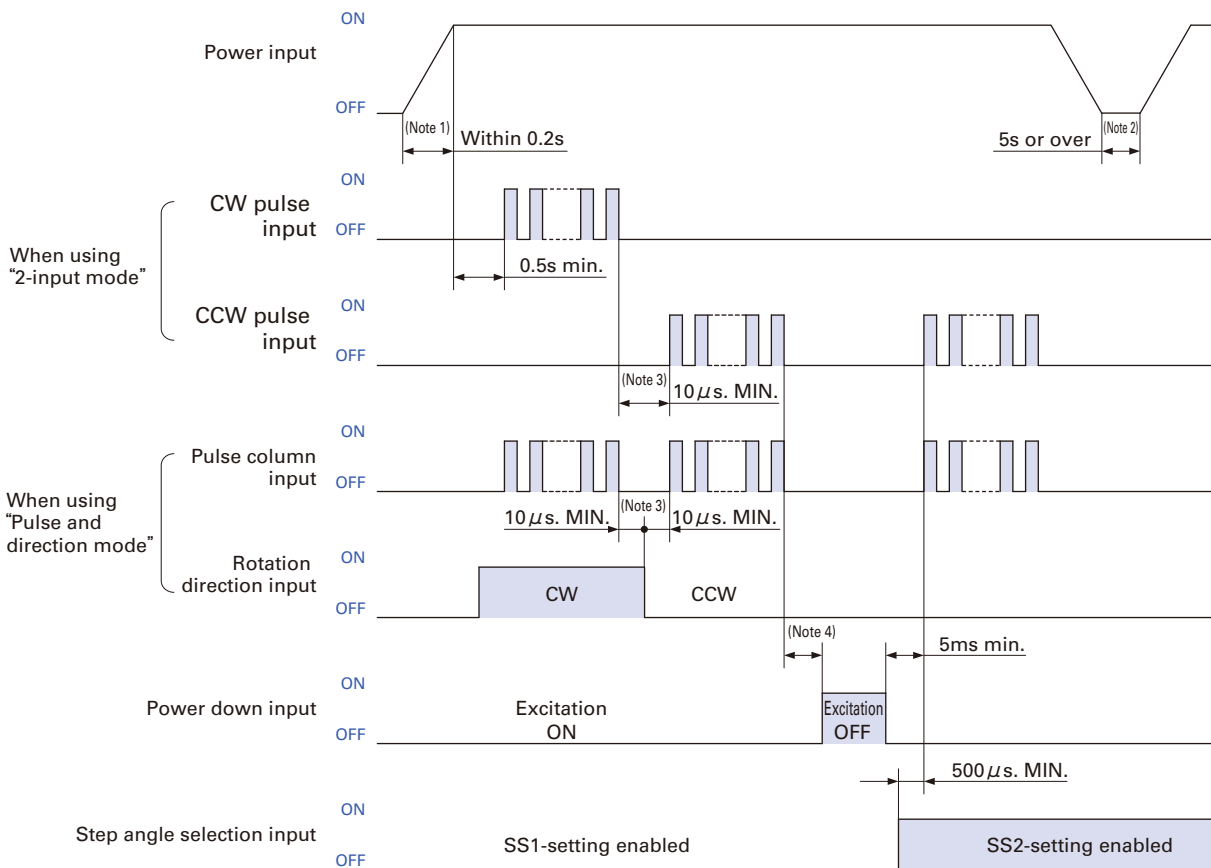

- The frequency of the power ON/OFF of the driver shall be 5 times/hour or less and 30 times/day or less.
- ■ indicates ON of photocoupler emitting side.
- When operating in double-input method, and then inputting pulse into CW, set CCW-side to "OFF."
When inputting pulse into CCW, set CW-side to "OFF."
- For input mode 1, CK should be off when switching input signal U/D.

(Note1) The time for the power supply to be established shall be within 0.2 seconds.

(Note2) Re-turning on the power supply shall be at intervals of more than 5 seconds.

(Note3) "10 μ s or more" shown above is response time within driver internal circuit, so set the time such that motor can response.

(Note4) Input power-down input signal in the state motor has been settled.

Input circuit configuration of ACDOFF, SSEL, PD

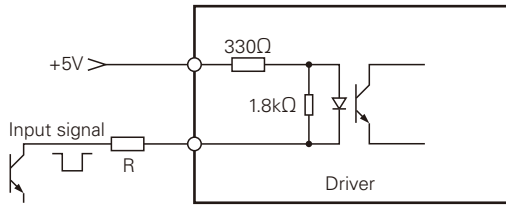

- When crest value of input signal exceeds 5V, add external limiting resistor R so that input current becomes approximately 10mA. (Consider photocoupler forward voltage: 1.5V)

Output signal configuration of MON, AL

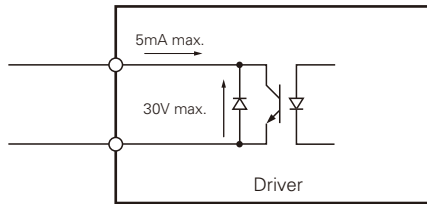

MON output

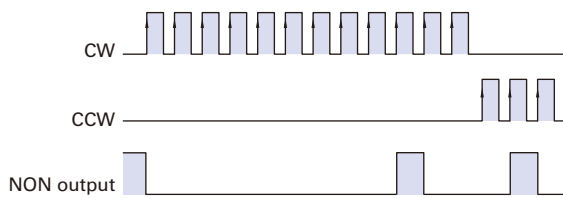

Example: 5-phase, full-division (Full Step)

- Photo coupler at phase origin of motor excitation (status at power on) is set to "ON"
- Inputting pulse turns on photocoupler every 7.2° of motor output axis from phase origin.
- Set command frequency to 50kpulse/s or less to use phase origin monitor.
- Perform switching of division number via step-angle selection input signal (SSEL) with phase origin monitor output turned on and motor being stopped.
- Switching division number at the point other than excitation origin may cause that phase origin monitor output is not correctly output.

Dimensions

Stepping motor for
vacuum environment

Linear Actuator
Stepping Motor

Stepping Motor

DC input Set model
Full / half step

DC input Set model
Micro step

AC input Set model
Micro step

DC input Set model

Full / half step

Set Model Configuration ▶ P.62
 Specifications · Characteristics ▶ P.63 to 77
 Motor specifications ▶ P.78 Driver specifications ▶ P.79
 Motor dimensions ▶ P.97 to 104 Driver dimensions ▶ P.105

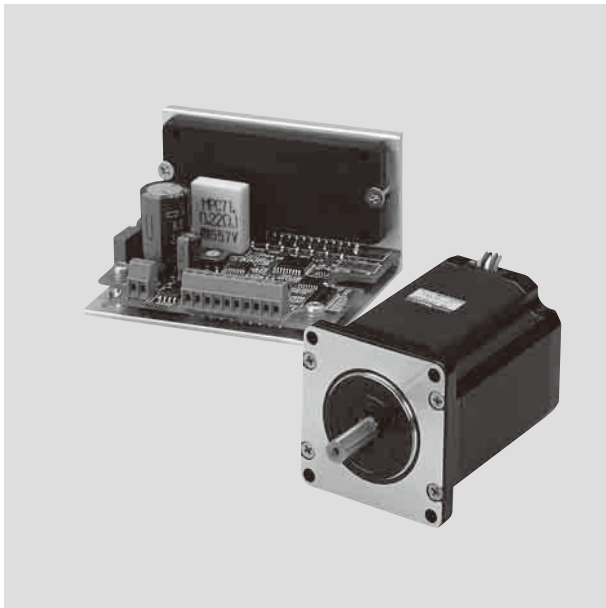

Features

- This DC driver and stepping motor set supports full- and half-step selection.

Set model configuration items

Driver CE c

Model number : FS1D140P10 Power supply : DC24V/36V

Motor

Motor size : 28mm sq. (1.10inch sq.),
 42mm sq. (1.65inch sq.), 60mm sq. (2.36inch sq.),
 φ86mm (φ3.39inch)

- Instruction manuals can be downloaded from our website.
- Prepare the cable according to the applicable wire sizes on P.81.

System configuration

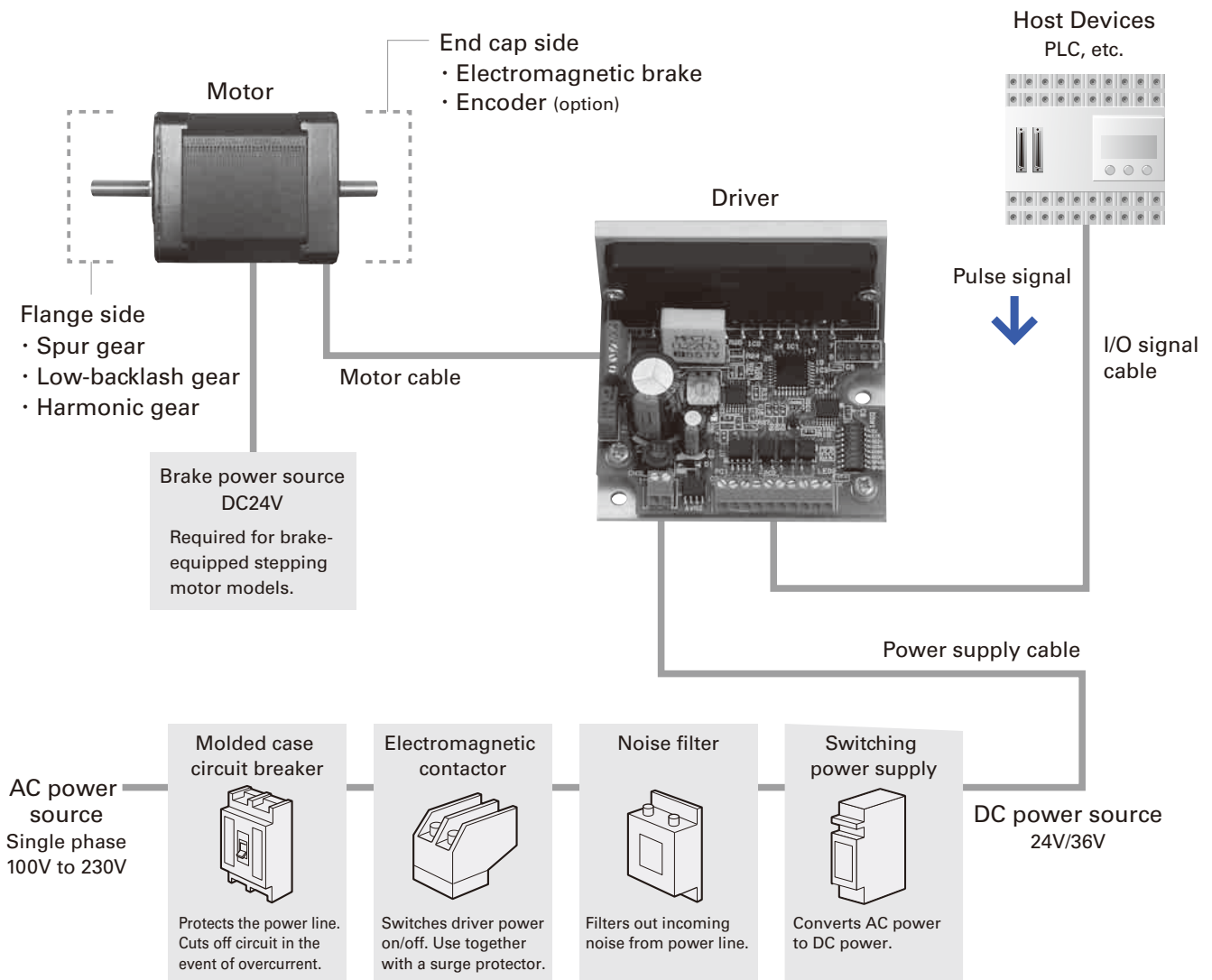

Model number convention

Example: The model number of the set with a DC driver and motor model 103F7851-82CXA4 is composed as follows.
 This motor is specified as 60mm sq. (2.36inch sq.) and 92mm (3.62inch) long (motor + gear), single shaft, with low back-lash gears.

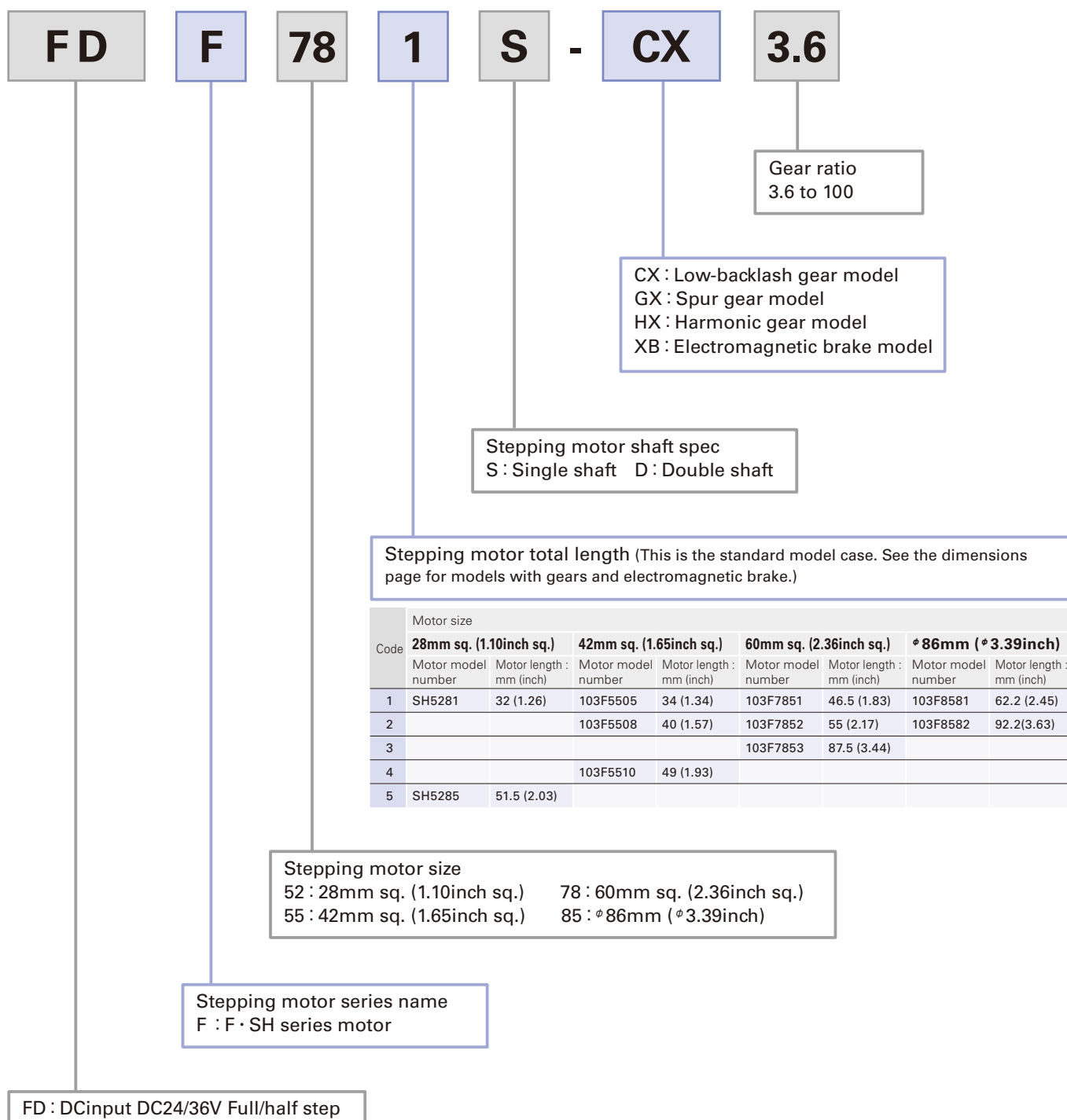

AC input Set model
Micro step

DC input Set model
Micro step

DC input Set model
Full / half step

Stepping Motor

Linear Actuator
Stepping Motor

Stepping motor for
vacuum environment

Dimensions

Set Model Configuration This is a set comprising a driver and motor.

DC input driver Model No. : FS1D140P10

Basic step angle/0.72°

Model	Motor size	Single shaft		Double shaft		Rated current (A/phase)	Page		
		Set model number	Set accessories	Set model number	Set accessories		Specifi-cations	Dimen-sions	
			Motor model number		Motor model number				
Standard model	28mm sq. (1.10inch sq.)	FD521S	SH5281-7241	FD521D	SH5281-7211	0.75	P.63	P.97	
		FD525S	SH5285-7241	FD525D	SH5285-7211	0.75	P.63	P.97	
	42mm sq. (1.65inch sq.)	FD551S	103F5505-8241	FD551D	103F5505-8211	1.4	P.63	P.97	
		FD552S	103F5508-8241	FD552D	103F5508-8211	1.4	P.63	P.97	
	60mm sq. (2.36inch sq.)	FD781S	103F7851-8241	FD781D	103F7851-8211	1.4	P.64	P.98	
		FD782S	103F7852-8241	FD782D	103F7852-8211	1.4	P.64	P.98	
	* 86mm (* 3.39inch)	FD851S	103F8581-8241	FD851D	103F8581-8211	1.4	P.65	P.99	
		FD852S	103F8582-8241	FD852D	103F8582-8211	1.4	P.65	P.99	
	Low-backlash gear model	42mm sq. (1.65inch sq.)	FD551S-CX3.6	103F5505-82CXA4	FD551D-CX3.6	103F5505-82CXA1	1.4	P.66	P.101
			FD551S-CX7.2	103F5505-82CXB4	FD551D-CX7.2	103F5505-82CXB1	1.4	P.66	P.101
FD551S-CX10			103F5505-82CXE4	FD551D-CX10	103F5505-82CXE1	1.4	P.66	P.101	
FD551S-CX20			103F5505-82CXG4	FD551D-CX20	103F5505-82CXG1	1.4	P.66	P.101	
FD551S-CX30			103F5505-82CXJ4	FD551D-CX30	103F5505-82CXJ1	1.4	P.67	P.101	
60mm sq. (2.36inch sq.)		FD781S-CX3.6	103F7851-82CXA4	FD781D-CX3.6	103F7851-82CXA1	1.4	P.67	P.101	
		FD781S-CX7.2	103F7851-82CXB4	FD781D-CX7.2	103F7851-82CXB1	1.4	P.67	P.101	
		FD781S-CX10	103F7851-82CXE4	FD781D-CX10	103F7851-82CXE1	1.4	P.68	P.101	
		FD781S-CX20	103F7851-82CXG4	FD781D-CX20	103F7851-82CXG1	1.4	P.68	P.101	
		FD781S-CX30	103F7851-82CXJ4	FD781D-CX30	103F7851-82CXJ1	1.4	P.68	P.101	
* 86mm (* 3.39inch)		FD851S-CX3.6	103F8581-82CXA4	FD851D-CX3.6	103F8581-82CXA1	1.4	P.69	P.101	
		FD851S-CX7.2	103F8581-82CXB4	FD851D-CX7.2	103F8581-82CXB1	1.4	P.69	P.101	
		FD851S-CX10	103F8581-82CXE4	FD851D-CX10	103F8581-82CXE1	1.4	P.69	P.101	
		FD851S-CX20	103F8581-82CXG4	FD851D-CX20	103F8581-82CXG1	1.4	P.69	P.101	
		FD851S-CX30	103F8581-82CXJ4	FD851D-CX30	103F8581-82CXJ1	1.4	P.70	P.101	
Spur gear model		28mm sq. (1.10inch sq.)	FD521S-GX3.6	SH5281-72GXA4	FD521D-GX3.6	SH5281-72GXA1	0.75	P.71	P.102
			FD521S-GX7.2	SH5281-72GXB4	FD521D-GX7.2	SH5281-72GXB1	0.75	P.71	P.102
			FD521S-GX10	SH5281-72GXE4	FD521D-GX10	SH5281-72GXE1	0.75	P.71	P.102
			FD521S-GX20	SH5281-72GXG4	FD521D-GX20	SH5281-72GXG1	0.75	P.71	P.102
			FD521S-GX30	SH5281-72GXJ4	FD521D-GX30	SH5281-72GXJ1	0.75	P.72	P.102
	42mm sq. (1.65inch sq.)	FD551S-HX50	SH5281-72HXL4	FD551D-HX50	SH5281-72HXL1	0.75	P.73	P.102	
		FD551S-HX100	SH5281-72HXM4	FD551D-HX100	SH5281-72HXM1	0.75	P.73	P.102	
		FD551S-HX30	103F5505-82HXJ5	FD551D-HX30	103F5505-82HXJ2	1.4	P.73	P.102	
		FD551S-HX50	103F5505-82HXL5	FD551D-HX50	103F5505-82HXL2	1.4	P.73	P.102	
		FD551S-HX100	103F5505-82HXM5	FD551D-HX100	103F5505-82HXM2	1.4	P.74	P.102	
60mm sq. (2.36inch sq.)	FD781S-HX50	103F7851-82HXL4	FD781D-HX50	103F7851-82HXL1	1.4	P.74	P.103		
	FD781S-HX100	103F7851-82HXM4	FD781D-HX100	103F7851-82HXM1	1.4	P.74	P.103		
	FD851S-HX50	103F8581-82HXL4	FD851D-HX50	103F8581-82HXL1	1.4	P.74	P.103		
	FD851S-HX100	103F8581-82HXM4	FD851D-HX100	103F8581-82HXM1	1.4	P.75	P.103		
	FD851S-HX30	103F8581-82HXL5	FD851D-HX30	103F8581-82HXL2	1.4	P.75	P.103		
Electromagnetic brake model	42mm sq. (1.65inch sq.)	FD551S-XB	103F5505-82XB41	—	—	1.4	P.76	P.104	
		FD552S-XB	103F5508-82XB41	—	—	1.4	P.76	P.104	
	60mm sq. (2.36inch sq.)	FD554S-XB	103F5510-82XB41	—	—	1.4	P.76	P.104	
		FD781S-XB	103F7851-82XB41	—	—	1.4	P.76	P.104	
	* 86mm (* 3.39inch)	FD782S-XB	103F7852-82XB41	—	—	1.4	P.77	P.104	
		FD783S-XB	103F7853-82XB41	—	—	1.4	P.77	P.104	
	* 86mm (* 3.39inch)	FD851S-XB	103F8581-82XB41	—	—	1.4	P.77	P.104	
		FD852S-XB	103F8582-82XB41	—	—	1.4	P.77	P.104	

Standard model DC input Driver (Model number : FS1D140P10) + Standard motor

Basic step angle : 0.72° Rated current : 28mm sq. (1.10inch sq.) Motor 0.75A/phase, 42mm sq. (1.65inch sq.) to ϕ 86mm(ϕ 3.39inch) Motor 1.4A/phase

Motor size		28mm sq. (1.10inch sq.)		42mm sq. (1.65inch sq.)	
Motor length		32mm (1.26inch)	51.5mm (2.03inch)	34mm (1.34inch)	40mm (1.57inch)
Single shaft	Set ordering model no.	FD521S	FD525S	FD551S	FD552S
	Corresponding motor model number	SH5281-7241	SH5285-7241	103F5505-8241	103F5508-8241
Double shaft	Set ordering model no.	FD521D	FD525D	FD551D	FD552D
	Corresponding motor model number	SH5281-7211	SH5285-7211	103F5505-8211	103F5508-8211
Holding torque	N · m (OZ · in)	0.041 (5.81)	0.078 (11.05)	0.13 (18.41)	0.18 (25.49)
Rotor inertia	$\times 10^{-4} \text{kg} \cdot \text{m}^2$ (OZ · in ²)	0.01 (0.05)	0.022 (0.09)	0.03 (0.16)	0.053 (0.29)
Motor mass ^(Note1)	kg (lbs)	0.11 (0.22)	0.2 (0.44)	0.23 (0.50)	0.28 (0.62)
Allowable thrust load	N (lbs)	3 (0.68)	3 (0.68)	10 (2.25)	10 (2.25)
Allowable radial load ^(Note2)	N (lbs)	42 (9.44)	53 (11.91)	35 (8.75)	35 (8.75)

(Note1) Driver mass ▶ P.79

(Note2) When load is applied at 1/3 length from output shaft edge.

Characteristics

Use the rubber coupling

Allowable torque Full step — Half step — fs : Maximum self-start frequency when not loaded Full step ● Half step ●
Source current (no load) Full step - - - Half step - - - Source current (load applied) Full step ····· Half step ·····

FD521S FD521D

Operating current : 0.75A/phase

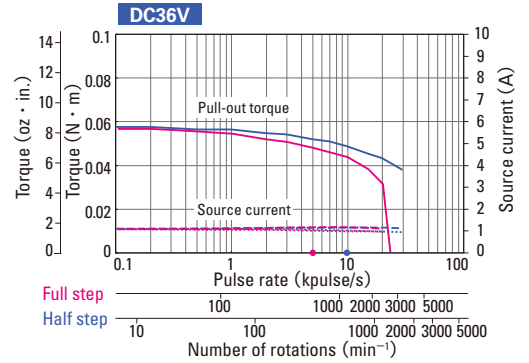
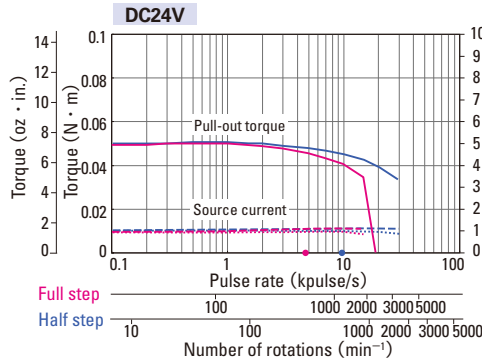

FD525S FD525D

Operating current : 0.75A/phase

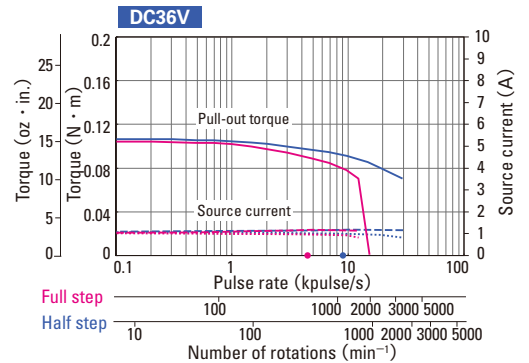
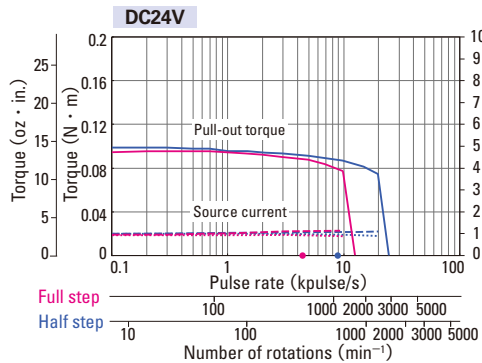

FD551S FD551D

Operating current : 1.4A/phase

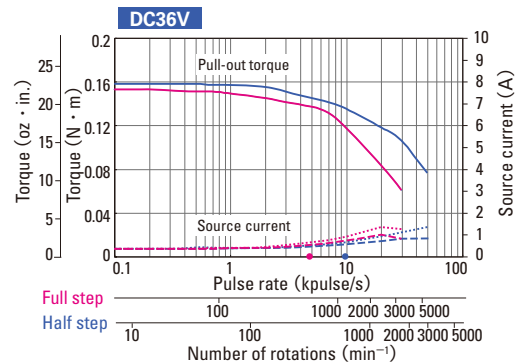
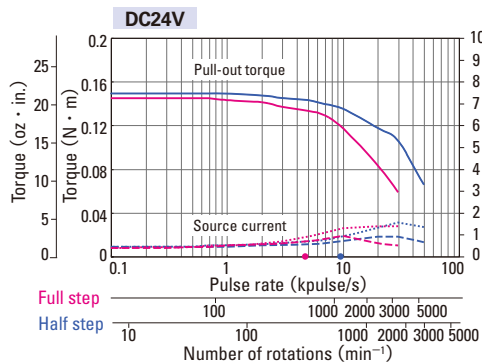

FD552S FD552D

Operating current : 1.4A/phase

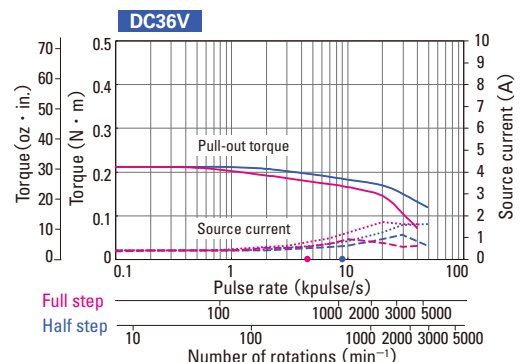
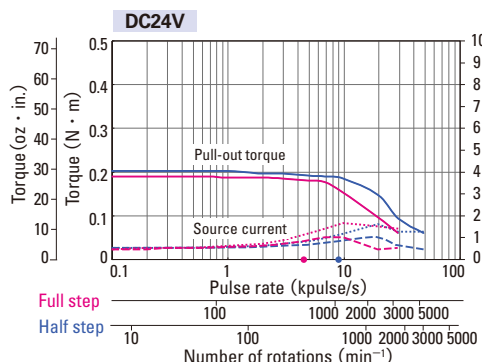

System configuration ▶ P.60 Set Model Configuration ▶ P.62 Motor dimensions ▶ P.97 to 100 Driver dimensions ▶ P.105 The data are measured under the drive condition of our company. The drive torque may vary depending on the accuracy of customer-side equipment.

AC input Set model
Micro step

DC input Set model
Micro step

DC input Set model
Full / half step

Stepping Motor

Linear Actuator
Stepping Motor

Stepping motor for
vacuum environment

Dimensions

Standard model DC input Driver (Model number : FS1D140P10) + Standard motor

Basic step angle : 0.72° Rated current : 28mm sq. (1.10inch sq.) Motor 0.75A/phase, 42mm sq. (1.65inch sq.) to 86mm(3.39inch) Motor 1.4A/phase

Motor size		42mm sq. (1.65inch sq.)	60mm sq. (2.36inch sq.)		
Motor length		49mm (1.93inch)	46.5mm (1.83inch)	55mm (2.17inch)	87.5mm (3.45inch)
Single shaft	Set ordering model no.	FD F554S	FD F781S	FD F782S	FD F783S
	Corresponding motor model number	103F5510-8241	103F7851-8241	103F7852-8241	103F7853-8241
Double shaft	Set ordering model no.	FD F554D	FD F781D	FD F782D	FD F783D
	Corresponding motor model number	103F5510-8211	103F7851-8211	103F7852-8211	103F7853-8211
Holding torque	N · m (OZ · in)	0.25 (35.4)	0.55 (77.9)	0.87 (123.2)	1.67 (236.5)
Rotor inertia	$\times 10^{-4} \text{kg} \cdot \text{m}^2 (\text{OZ} \cdot \text{in}^2)$	0.065 (0.36)	0.275 (1.50)	0.4 (2.19)	0.84 (4.59)
Motor mass ^(Note1)	kg (lbs)	0.37 (0.81)	0.6 (1.32)	0.78 (1.72)	1.36 (3.0)
Allowable thrust load	N (lbs)	10 (2.25)	20 (4.5)	20 (4.5)	20 (4.5)
Allowable radial load ^(Note2)	N (lbs)	35 (8.75)	80 (18)	80 (18)	80 (18)

(Note1) Driver mass ▶ P.79

(Note2) When load is applied at 1/3 length from output shaft edge.

Characteristics

Operating current : 1.4A/phase
Use the rubber coupling

Pull-out torque Source current (no load) Full step — Half step — fs : Maximum self-start frequency when not loaded Full step ● Half step ●
Source current (load applied) Full step - - - Half step - - -

FD F554S
FD F554D

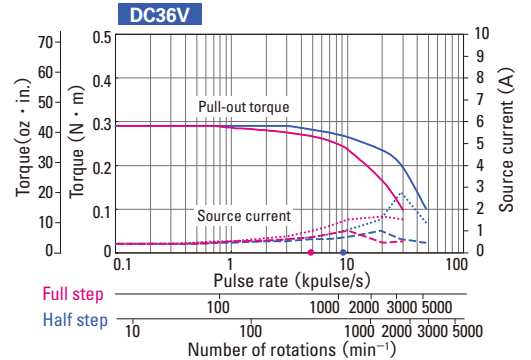
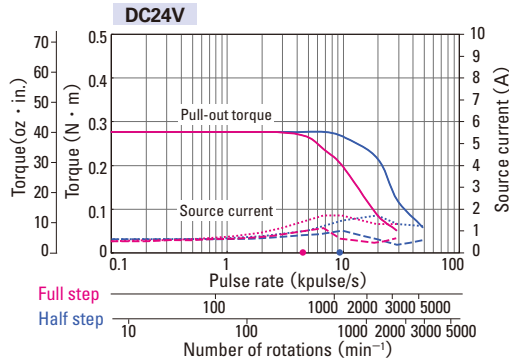

FD F781S
FD F781D

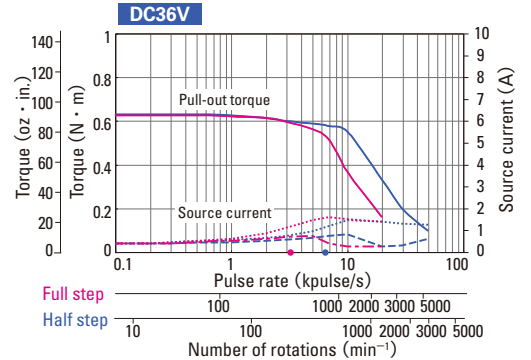
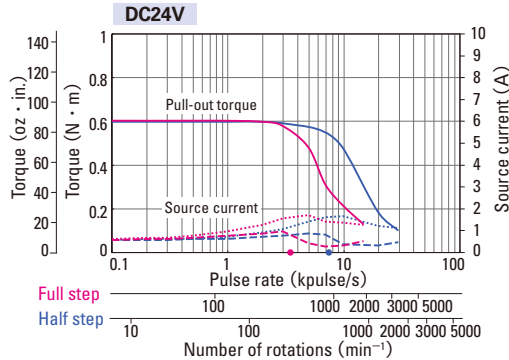

FD F782S
FD F782D

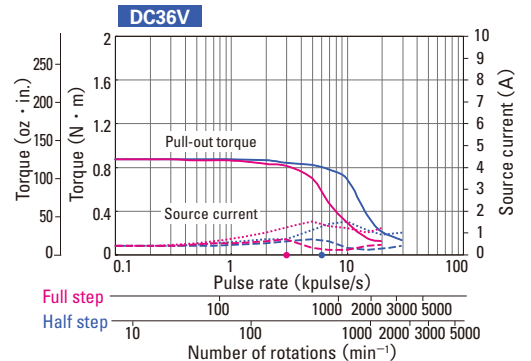
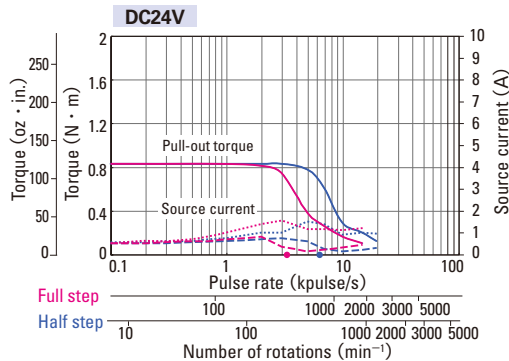

FD F783S
FD F783D

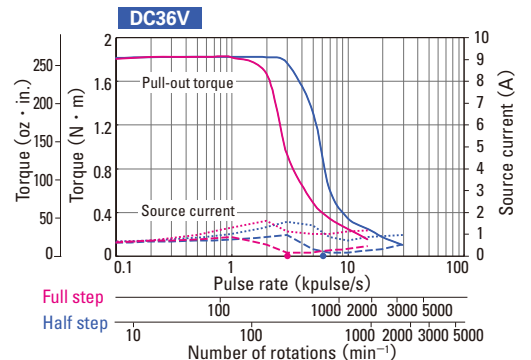
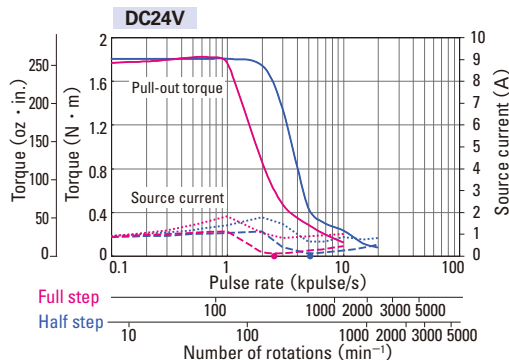

System configuration ▶ P.60 Set Model Configuration ▶ P.62 Motor dimensions ▶ P.97 to 100 Driver dimensions ▶ P.105 The data are measured under the drive condition of our company. The drive torque may vary depending on the accuracy of customer-side equipment.

Motor size		φ86mm (φ3.39inch)	
Motor length		62.15mm (2.47inch)	92.2mm (3.63inch)
Single shaft	Set ordering model no.	FDF851S	FDF852S
	Corresponding motor model number	103F8581-8241	103F8582-8241
Double shaft	Set ordering model no.	FDF851D	FDF852D
	Corresponding motor model number	103F8581-8211	103F8582-8211
Holding torque	N · m (OZ · in)	2 (283.2)	4.02 (569.3)
Rotor inertia	$\times 10^{-4}$ kg · m ² (OZ · in ²)	1.45 (7.93)	2.9 (15.86)
Motor mass ^(Note1)	kg (lbs)	1.5 (3.3)	2.5 (5.5)
Allowable thrust load	N (lbs)	60 (13.5)	60 (13.5)
Allowable radial load ^(Note2)	N (lbs)	220 (49.5)	220 (49.5)

(Note1) Driver mass ▶ P.79
(Note2) When load is applied at 1/3 length from output shaft edge.

Characteristics

Operating current : 1.4A/phase
Use the rubber coupling

Pull-out torque Full step ———— Half step ———— fs : Maximum self-start frequency when not loaded Full step ● Half step ●
Source current (no load) Full step - - - - - Half step - - - - - Source current (load applied) Full step Half step

FDF851S FDF851D

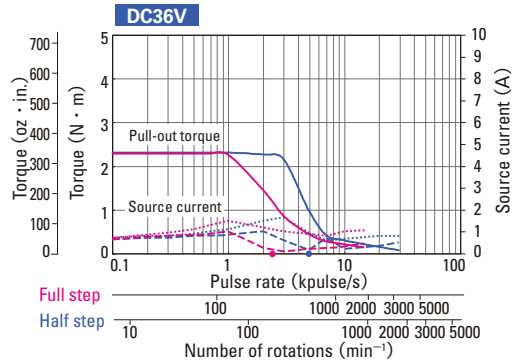
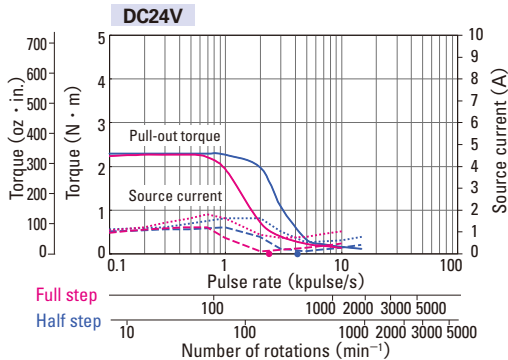

FDF852S FDF852D

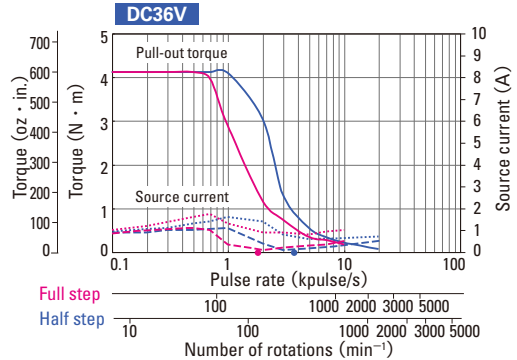
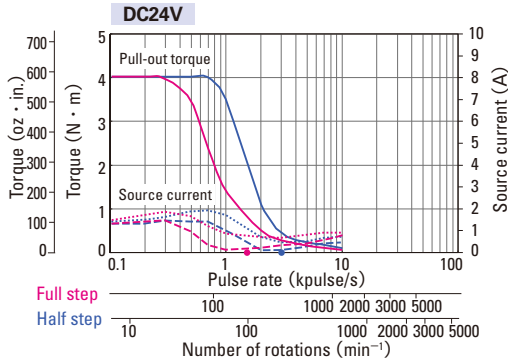

Low-backlash gear model

DC input Driver (Model number : F5PAE140P100) + Motor with low-backlash gear

Rated current : 1.4A/phase

Motor size		42mm sq. (1.65inch sq.)			
Motor + gear length		64.5mm (2.54inch)	64.5mm (2.54inch)	64.5mm (2.54inch)	64.5mm (2.54inch)
Single shaft	Set ordering model no.	FD551S-CX3.6	FD551S-CX7.2	FD551S-CX10	FD551S-CX20
	Corresponding motor model number	103F5505-82CX4A	103F5505-82CXB4	103F5505-82CXE4	103F5505-82CXG4
Double shaft	Set ordering model no.	FD551D-CX3.6	FD551D-CX7.2	FD551D-CX10	FD551D-CX20
	Corresponding motor model number	103F5505-82CXA1	103F5505-82CXB1	103F5505-82CXE1	103F5505-82CXG1
Allowable torque	N · m (OZ · in)	0.343 (48.6)	0.686 (97.1)	0.98 (138.8)	1.47 (208.2)
Rotor inertia	$\times 10^{-4} \text{kg} \cdot \text{m}^2 (\text{OZ} \cdot \text{in}^2)$	0.03 (0.16)	0.03 (0.16)	0.03 (0.16)	0.03 (0.16)
Basic step angle	DEG	0.2	0.1	0.072	0.036
Gear ratio	-	1 : 3.6	1 : 7.2	1 : 10	1 : 20
Backlash	DEG	0.6	0.4	0.35	0.25
Allowable speed	min ⁻¹	500	250	180	90
Motor mass ^(Note1)	kg (lbs)	0.36 (0.79)	0.36 (0.79)	0.36 (0.79)	0.36 (0.79)
Allowable thrust load	N (lbs)	15 (3.38)	15 (3.38)	15 (3.38)	15 (3.38)
Allowable radial load ^(Note2)	N (lbs)	20 (4.5)	20 (4.5)	20 (4.5)	20 (4.5)

Directions of motor rotation and gear output shaft are the same for models with reduction ratio 1 : 3.6, 1 : 7.2 and 1 : 10 opposite for reduction ratio 1 : 20, 1 : 30, and 1 : 36.

(Note1) Driver mass ▶ P.79

(Note2) When load is applied at 1/3 length from output shaft edge.

Characteristics

Operating current : 1.4A/phase
Use the rubber coupling

Allowable torque Full step — Half step —
Source current (no load) Full step - - - Half step - - -
Source current (load applied) Full step ····· Half step ·····

FD551S-CX3.6
FD551D-CX3.6

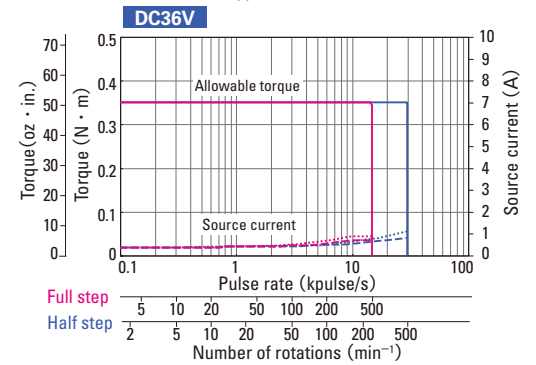
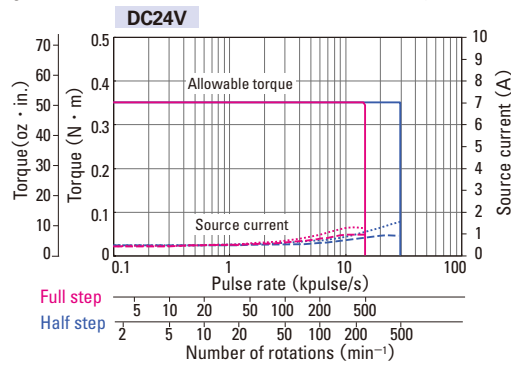

FD551S-CX7.2
FD551D-CX7.2

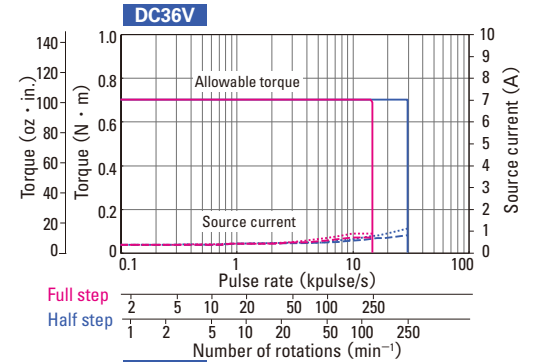
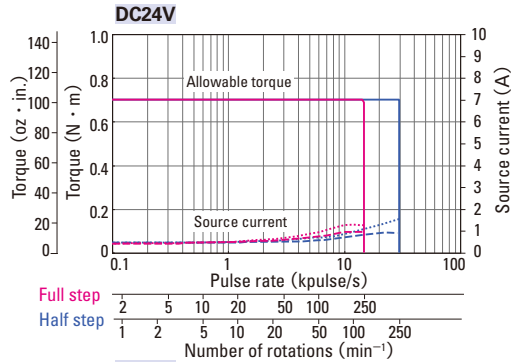

FD551S-CX10
FD551D-CX10

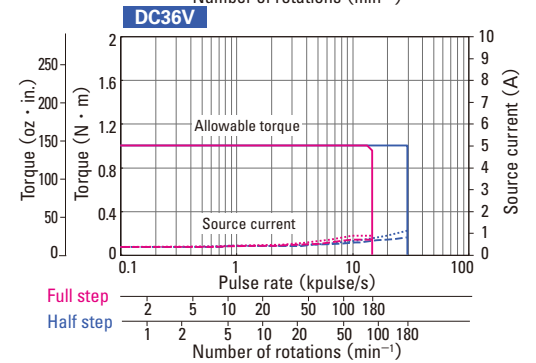
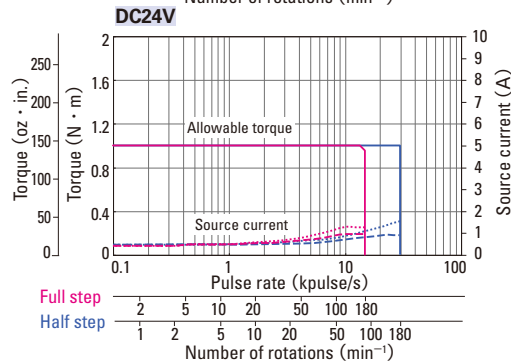

FD551S-CX20
FD551D-CX20

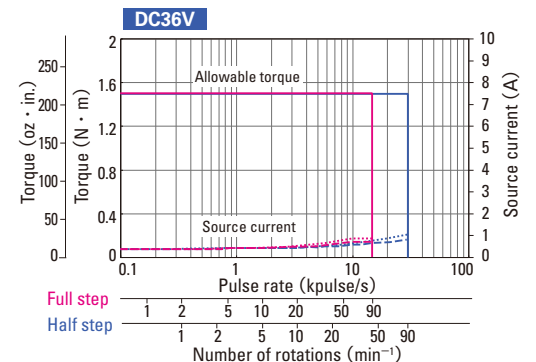
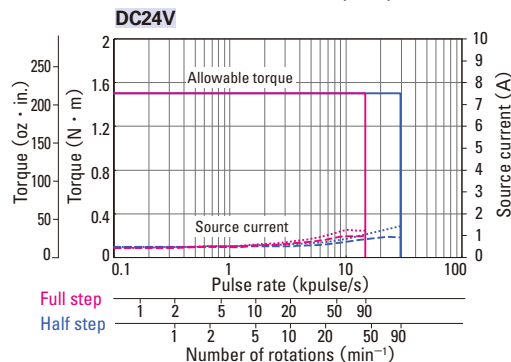

In motor+gear models, the gears may be damaged if allowable torque is exceeded. When selecting a motor, ensure that its allowable torque will not be exceeded. System configuration ▶ P.60 Set Model Configuration ▶ P.62 Motor dimensions ▶ P.101 Driver dimensions ▶ P.105 The data are measured under the drive condition of our company. The drive torque may very depending on the accuracy of customer-side equipment.

Motor size		42mm sq. (1.65inch sq.)		60mm sq. (2.36inch sq.)	
Motor + gear length		64.5mm (2.54inch)	64.5mm (2.54inch)	92mm (3.62inch)	92mm (3.62inch)
Single shaft	Set ordering model no.	FD551S-CX30	FD551S-CX36	FD781S-CX3.6	FD781S-CX7.2
	Corresponding motor model number	103F5505-82CXJ4	103F5505-82CXK4	103F7851-82CXA4	103F7851-82CXB4
Double shaft	Set ordering model no.	FD551D-CX30	FD551D-CX36	FD781D-CX3.6	FD781D-CX7.2
	Corresponding motor model number	103F5505-82CXJ1	103F5505-82CXK1	103F7851-82CXA1	103F7851-82CXB1
Allowable torque	N · m (OZ · in)	1.47 (208.2)	1.47 (208.2)	1.25 (177.0)	2.5 (354.0)
Rotor inertia	$\times 10^{-4}$ kg · m ² (OZ · in ²)	0.03 (0.16)	0.03 (0.16)	0.275 (1.5)	0.275 (1.5)
Basic step angle	DEG	0.024	0.02	0.2	0.1
Gear ratio	-	1 : 30	1 : 36	1 : 3.6	1 : 7.2
Backlash	DEG	0.25	0.25	0.55	0.25
Allowable speed	min ⁻¹	60	50	500	250
Motor mass ^(Note1)	kg (lbs)	0.36 (0.79)	0.36 (0.79)	0.97 (2.13)	0.97 (2.13)
Allowable thrust load	N (lbs)	15 (3.38)	15 (3.38)	30 (6.75)	30 (6.75)
Allowable radial load ^(Note2)	N (lbs)	20 (4.5)	20 (4.5)	100 (22.5)	100 (22.5)

The directions of motor rotation and gear output axle rotation for 42 mm models are the same for 1:3.6, 1:7.2 and 1:10 reduction ratios, and opposite for 1:20, 1:30 and 1:36 reduction ratios. For 60 mm models, rotation directions are the same for 1:3.6 and 1:7.2 reduction ratios, and opposite for 1:10, 1:20, 1:30 and 1:36 reduction ratios.

(Note1) Driver mass ▶ P.79

(Note2) When load is applied at 1/3 length from output shaft edge.

Characteristics

Operating current : 1.4A/phase
Use the rubber coupling

Allowable torque Full step — Half step —
Source current (no load) Full step - - - Half step - - -
Source current (load applied) Full step ····· Half step ·····

FD551S-CX30
FD551D-CX30

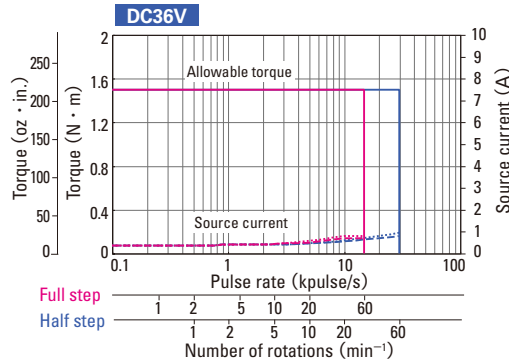
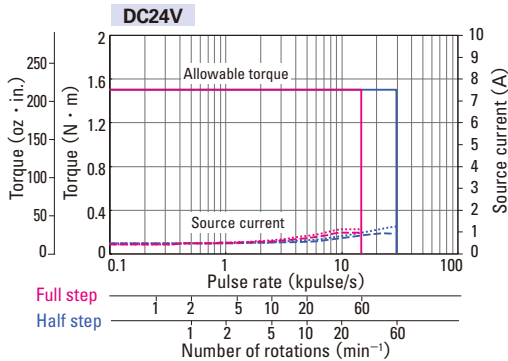

FD551S-CX36
FD551D-CX36

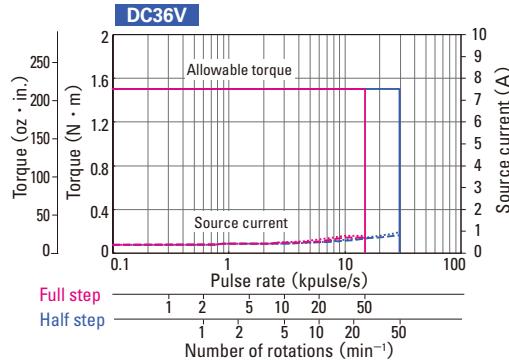
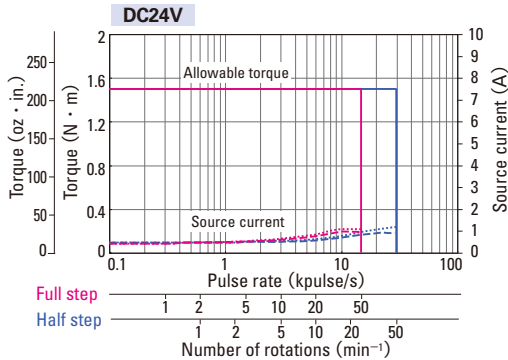

FD781S-CX3.6
FD781D-CX3.6

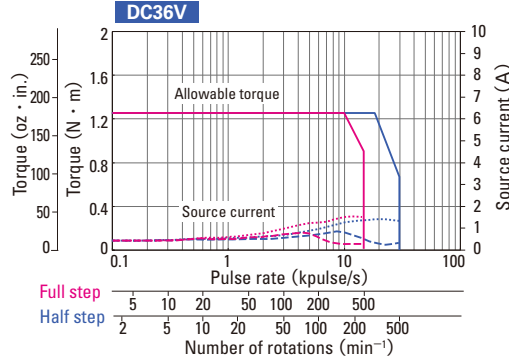
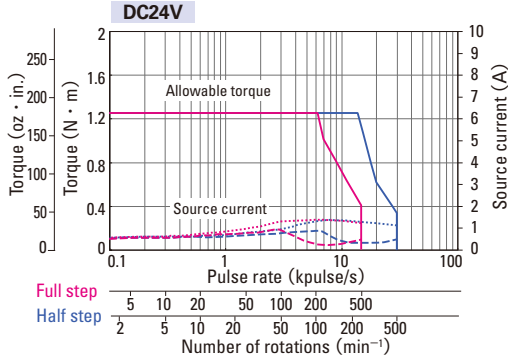

FD781S-CX7.2
FD781D-CX7.2

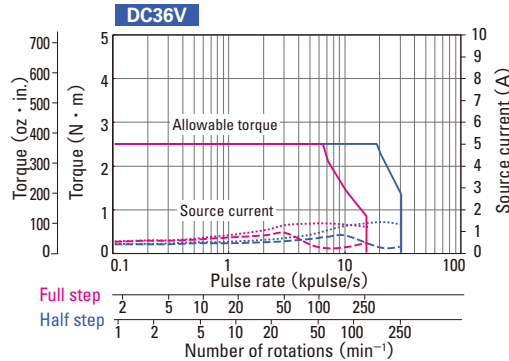
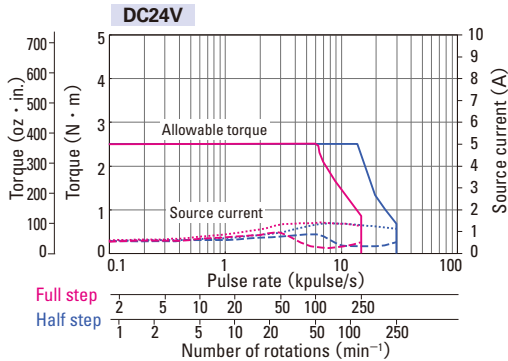

In motor+gear models, the gears may be damaged if allowable torque is exceeded. When selecting a motor, ensure that its allowable torque will not be exceeded. System configuration ▶ P.60 Set Model Configuration ▶ P.62 Motor dimensions ▶ P.101 Driver dimensions ▶ P.105 The data are measured under the drive condition of our company. The drive torque may very depending on the accuracy of customer-side equipment.

Low-backlash gear model

DC input Driver (Model number : FS1D140P10) + Motor with low-backlash gear

Rated current : 1.4A/phase

Motor size		60mm sq. (2.36inch sq.)			
Motor + gear length		92mm (3.62inch)	92mm (3.62inch)	92mm (3.62inch)	92mm (3.62inch)
Single shaft	Set ordering model no.	FD781S-CX10	FD781S-CX20	FD781S-CX30	FD781S-CX36
	Corresponding motor model number	103F7851-82CXE4	103F7851-82CXG4	103F7851-82CXJ4	103F7851-82CXX4
Double shaft	Set ordering model no.	FD781D-CX10	FD781D-CX20	FD781D-CX30	FD781D-CX36
	Corresponding motor model number	103F7851-82CXE1	103F7851-82CXG1	103F7851-82CXJ1	103F7851-82CXX1
Allowable torque	N · m (OZ · in)	3 (424.8)	3.5 (495.6)	4 (566.4)	4 (566.4)
Rotor inertia	$\times 10^{-4}$ kg · m ² (OZ · in ²)	0.275 (1.5)	0.275 (1.5)	0.275 (1.5)	0.275 (1.5)
Basic step angle	DEG	0.072	0.036	0.024	0.02
Gear ratio	-	1 : 10	1 : 20	1 : 30	1 : 36
Backlash	DEG	0.25	0.17	0.17	0.17
Allowable speed	min ⁻¹	180	90	60	50
Motor mass ^(Note1)	kg (lbs)	0.97 (2.13)	0.97 (2.13)	0.97 (2.13)	0.97 (2.13)
Allowable thrust load	N (lbs)	30 (6.75)	30 (6.75)	30 (6.75)	30 (6.75)
Allowable radial load ^(Note2)	N (lbs)	100 (22.5)	100 (22.5)	100 (22.5)	100 (22.5)

The directions of motor rotation and gear output axle rotation are the same for models with reduction ratio 1:3.6 and 1:7.2 reduction ratios, and opposite for 1:10, 1:20, 1:30 and 1:36 reduction ratios.

(Note1) Driver mass ▶ P.79

(Note2) When load is applied at 1/3 length from output shaft edge.

Characteristics

Operating current : 1.4A/phase
Use the rubber coupling

Allowable torque Full step — Half step —
Source current (no load) Full step - - - Half step - - -
Source current (load applied) Full step ····· Half step ·····

FD781S-CX10
FD781D-CX10

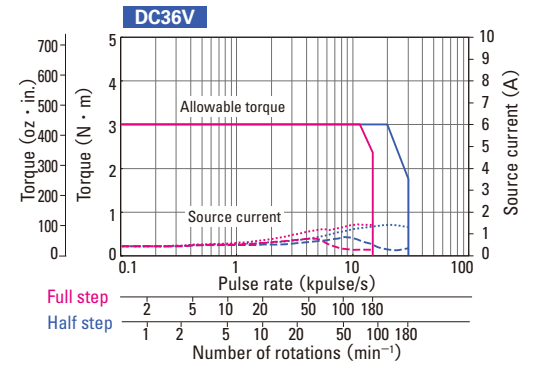
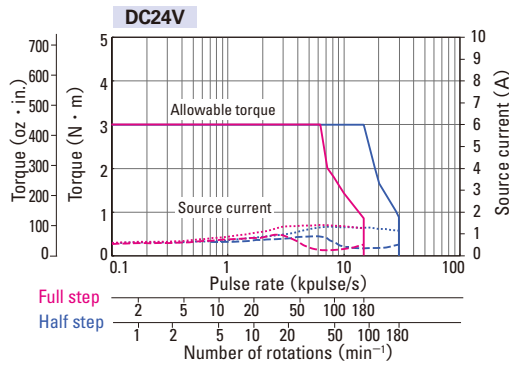

FD781S-CX20
FD781D-CX20

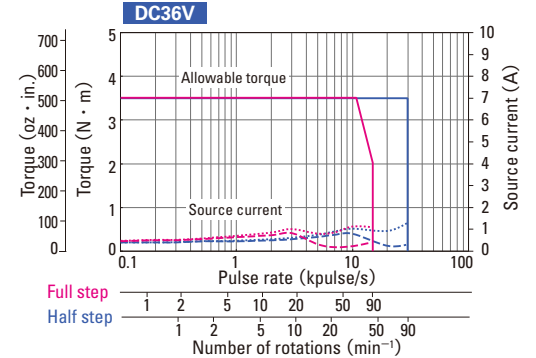
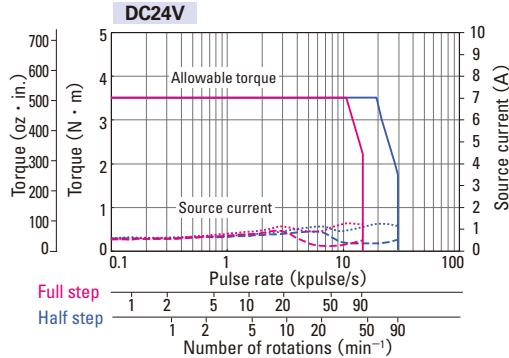

FD781S-CX30
FD781D-CX30

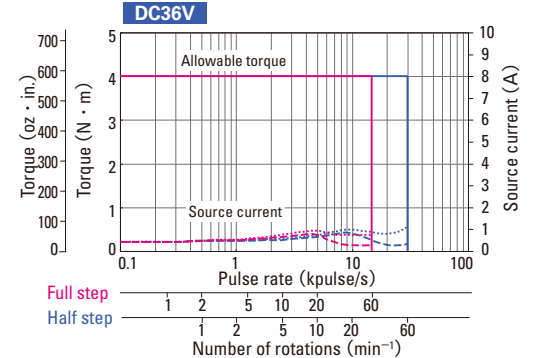
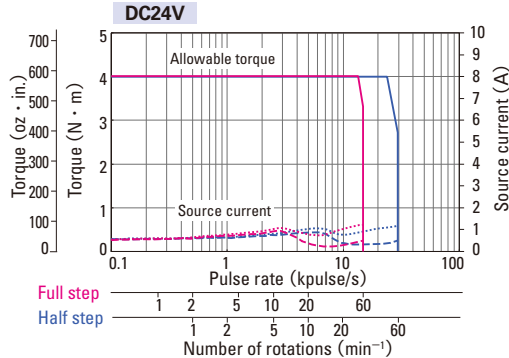

FD781S-CX36
FD781D-CX36

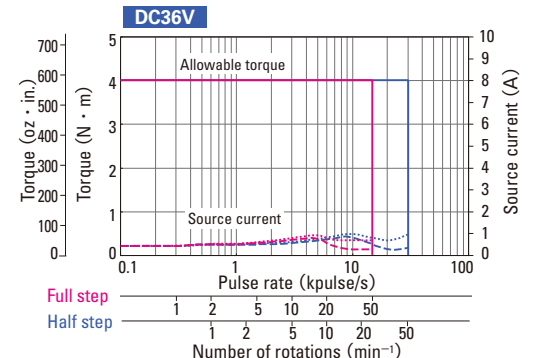
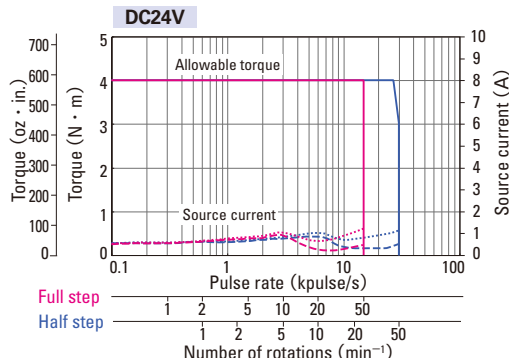

In motor+gear models, the gears may be damaged if allowable torque is exceeded. When selecting a motor, ensure that its allowable torque will not be exceeded. System configuration ▶ P.60 Set Model Configuration ▶ P.62 Motor dimensions ▶ P.101 Driver dimensions ▶ P.105 The data are measured under the drive condition of our company. The drive torque may very depending on the accuracy of customer-side equipment.

Motor size		φ86mm (φ3.39inch)			
Motor + gear length		127.3mm (5.01inch)	127.3mm (5.01inch)	127.3mm (5.01inch)	127.3mm (5.01inch)
Single shaft	Set ordering model no.	FD851S-CX3.6	FD851S-CX7.2	FD851S-CX10	FD851S-CX20
	Corresponding motor model number	103F8581-82CX44	103F8581-82CXB4	103F8581-82CXE4	103F8581-82CXG4
Double shaft	Set ordering model no.	FD851D-CX3.6	FD851D-CX7.2	FD851D-CX10	FD851D-CX20
	Corresponding motor model number	103F8581-82CXA1	103F8581-82CXB1	103F8581-82CXE1	103F8581-82CXG1
Allowable torque	N · m (OZ · in)	4.5 (637.2)	9 (1274.5)	9 (1274.5)	12 (1699.3)
Rotor inertia	× 10 ⁻⁴ kg · m ² (OZ · in ²)	1.45 (7.93)	1.45 (7.93)	1.45 (7.93)	1.45 (7.93)
Basic step angle	DEG	0.2	0.1	0.072	0.036
Gear ratio	-	1 : 3.6	1 : 7.2	1 : 10	1 : 20
Backlash	DEG	0.35	0.22	0.22	0.15
Allowable speed	min ⁻¹	500	250	180	90
Motor mass ^(Note1)	kg (lbs)	2.7 (5.94)	2.7 (5.94)	2.7 (5.94)	2.7 (5.94)
Allowable thrust load	N (lbs)	60 (13.5)	60 (13.5)	60 (13.5)	60 (13.5)
Allowable radial load ^(Note2)	N (lbs)	300 (67.5)	300 (67.5)	300 (67.5)	300 (67.5)

The directions of motor rotation and gear output axle rotation are the same for models with reduction ratio 1:3.6 and 1:7.2 reduction ratios, and opposite for 1:10, 1:20, 1:30 and 1:36 reduction ratios.

(Note1) Driver mass ▶ P.79

(Note2) When load is applied at 1/3 length from output shaft edge.

Characteristics

Operating current : 1.4A/phase
Use the rubber coupling

Allowable torque Full step — Half step —
Source current (no load) Full step - - - Half step - - -
Source current (load applied) Full step ····· Half step ·····

FD851S-CX3.6
FD851D-CX3.6

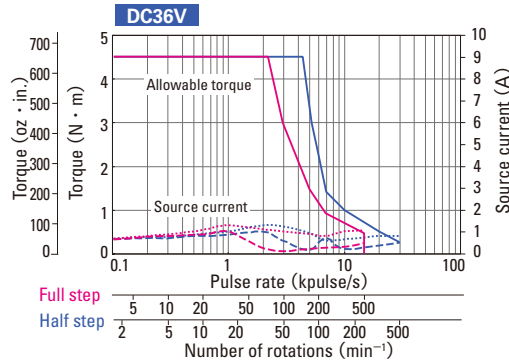
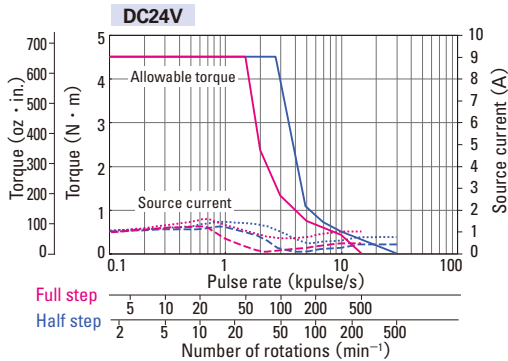

FD851S-CX7.2
FD851D-CX7.2

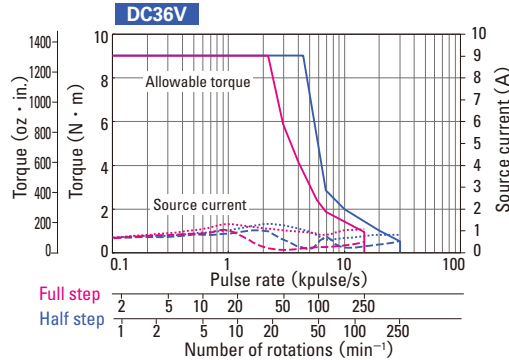
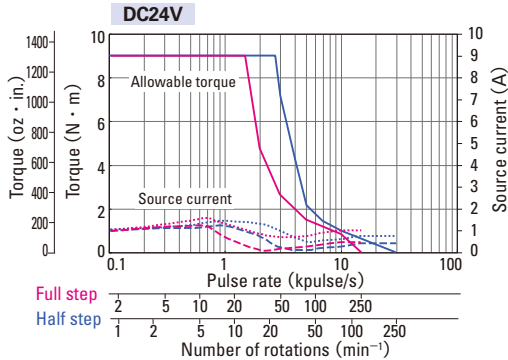

FD851S-CX10
FD851D-CX10

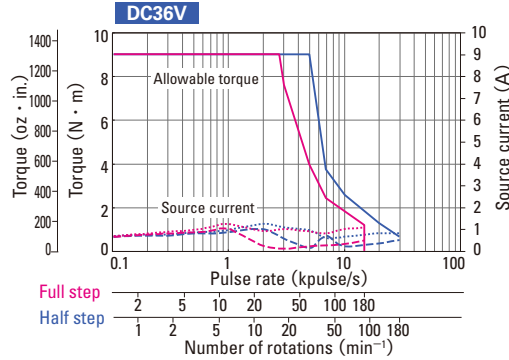
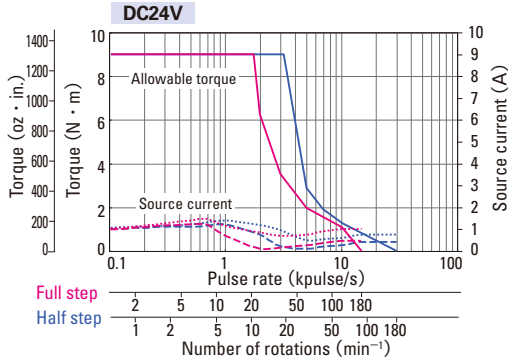

FD851S-CX20
FD851D-CX20

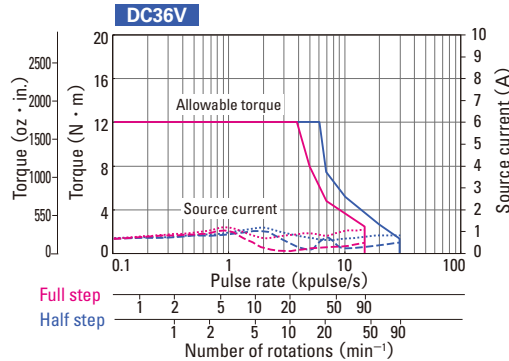
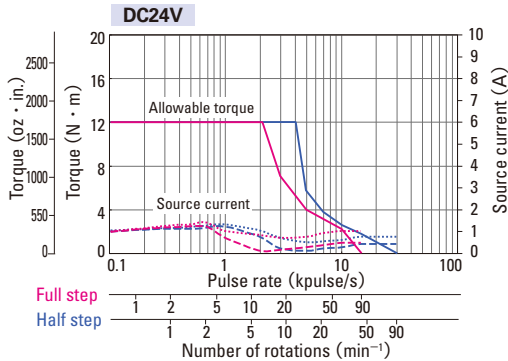

In motor+gear models, the gears may be damaged if allowable torque is exceeded. When selecting a motor, ensure that its allowable torque will not be exceeded. System configuration ▶ P.60 Set Model Configuration ▶ P.62 Motor dimensions ▶ P.101 Driver dimensions ▶ P.105 The data are measured under the drive condition of our company. The drive torque may very depending on the accuracy of customer-side equipment.

Low-backlash gear model

DC input Driver (Model number : FS1D140P10) + Motor with low-backlash gear

Rated current : 1.4A/phase

Motor size		φ86mm (φ3.39inch)	
Motor + gear length		127.3mm (5.01inch)	127.3mm (5.01inch)
Single shaft	Set ordering model no.	FDF851S-CX30	FDF851S-CX36
	Corresponding motor model number	103F8581-82CXJ4	103F8581-82CXK4
Double shaft	Set ordering model no.	FDF851D-CX30	FDF851D-CX36
	Corresponding motor model number	103F8581-82CXJ1	103F8581-82CXK1
Allowable torque	N · m (OZ · in)	12 (1699.3)	12 (1699.3)
Rotor inertia	$\times 10^{-4}$ kg · m ² (OZ · in ²)	1.45 (7.93)	1.45 (7.93)
Basic step angle	DEG	0.024	0.02
Gear ratio	-	1 : 30	1 : 36
Backlash	DEG	0.15	0.15
Allowable speed	min ⁻¹	60	50
Motor mass ^(Note1)	kg (lbs)	2.7 (5.94)	2.7 (5.94)
Allowable thrust load	N (lbs)	60 (13.5)	60 (13.5)
Allowable radial load ^(Note2)	N (lbs)	300 (67.5)	300 (67.5)

The directions of motor rotation and gear output axle rotation are the same for models with reduction ratio 1:3.6 and 1:7.2 reduction ratios, and opposite for 1:10, 1:20, 1:30 and 1:36 reduction ratios.

(Note1) Driver mass ▶ P.79

(Note2) When load is applied at 1/3 length from output shaft edge.

Characteristics

Operating current : 1.4A/phase
Use the rubber coupling

FDF851S-CX30
FDF851D-CX30

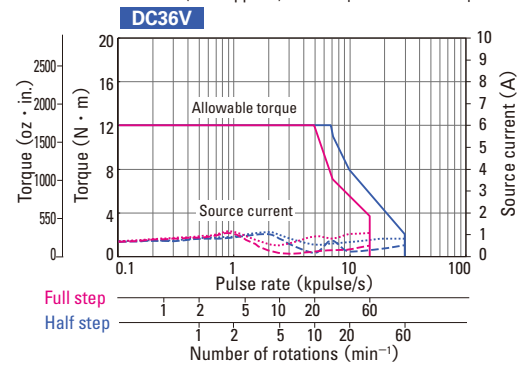
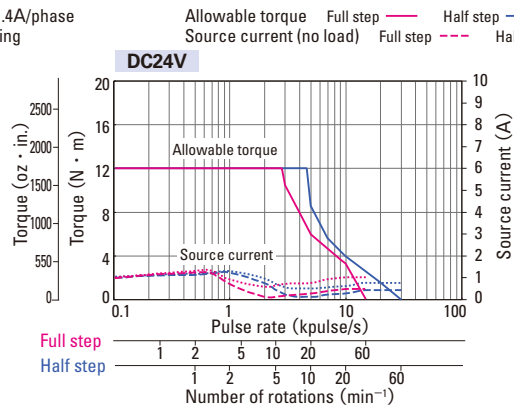

FDF851S-CX36
FDF851D-CX36

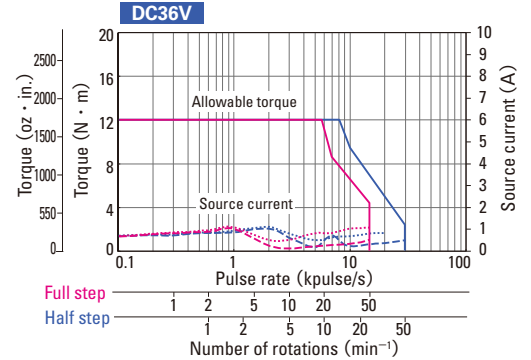
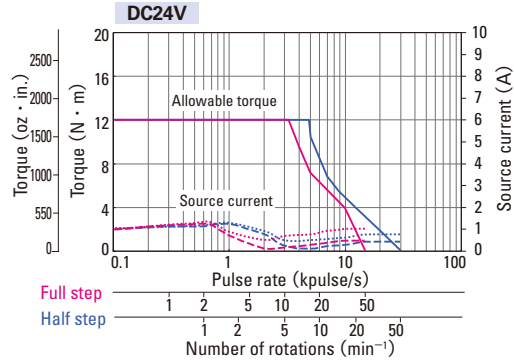

Spur gear model

DC input Driver (Model number : FS1D140P10) + Motor with spur gear

Rated current : 0.75A/phase

Motor size		28mm sq. (1.10inch sq.)			
Motor + gear length		61.5mm (2.42inch)	61.5mm (2.42inch)	61.5mm (2.42inch)	61.5mm (2.42inch)
Single shaft	Set ordering model no.	FD521S-GX3.6	FD521S-GX7.2	FD521S-GX10	FD521S-GX20
	Corresponding motor model number	SH5281-72GXA4	SH5281-72GXB4	SH5281-72GXE4	SH5281-72GXG4
Double shaft	Set ordering model no.	FD521D-GX3.6	FD521D-GX7.2	FD521D-GX10	FD521D-GX20
	Corresponding motor model number	SH5281-72GXA1	SH5281-72GXB1	SH5281-72GXE1	SH5281-72GXG1
Allowable torque	N · m (OZ · in)	0.1 (14.16)	0.15 (21.24)	0.2 (28.32)	0.35 (49.6)
Rotor inertia	$\times 10^{-4}$ kg · m ² (OZ · in ²)	0.01 (0.05)	0.01 (0.05)	0.01 (0.05)	0.01 (0.05)
Basic step angle	DEG	0.2	0.1	0.072	0.036
Gear ratio	-	1 : 3.6	1 : 7.2	1 : 10	1 : 20
Backlash	DEG	2	2	2	1.5
Allowable speed	min ⁻¹	800	400	300	150
Motor mass ^(Note1)	kg (lbs)	0.17 (0.37)	0.17 (0.37)	0.17 (0.37)	0.17 (0.37)
Allowable thrust load	N (lbs)	10 (2.25)	10 (2.25)	10 (2.25)	10 (2.25)
Allowable radial load ^(Note2)	N (lbs)	15 (3.38)	15 (3.38)	15 (3.38)	15 (3.38)

The directions of motor rotation and gear output axle rotation are the same for models with reduction ratio 1:3.6, 1:7.2, 1:20, 1:30 and 1:50 reduction ratios, and opposite for 1:10 reduction ratios.

(Note1) Driver mass ▶ P.79

(Note2) When load is applied at 1/3 length from output shaft edge.

Characteristics

Operating current : 0.75A/phase
Use the rubber coupling

Allowable torque Full step — Half step —
Source current (no load) Full step - - - Half step - - -
Source current (load applied) Full step ····· Half step ·····

FD521S-GX3.6
FD521D-GX3.6

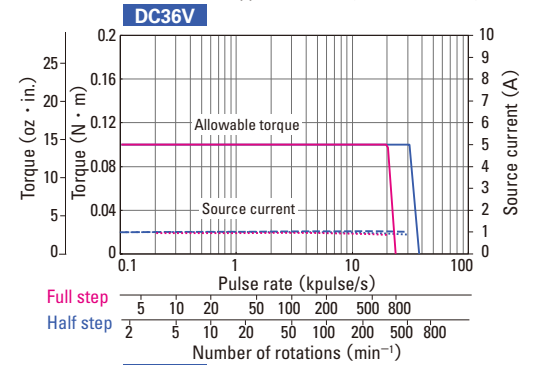
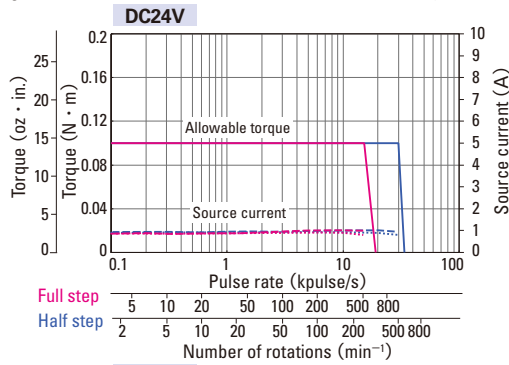

FD521S-GX7.2
FD521D-GX7.2

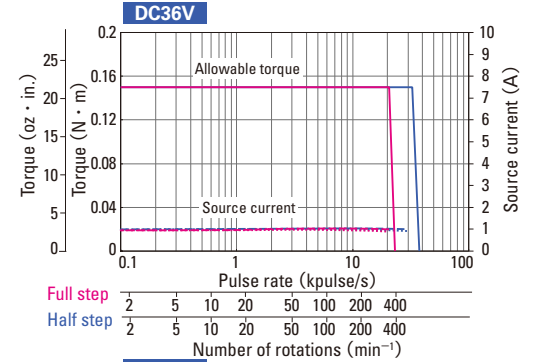
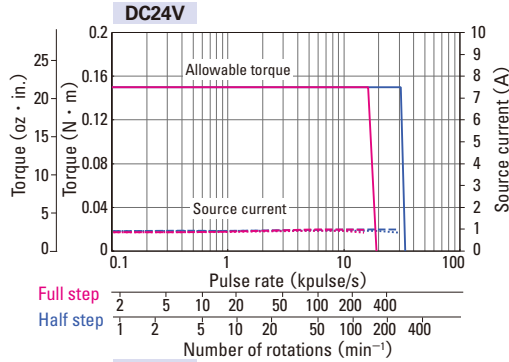

FD521S-GX10
FD521D-GX10

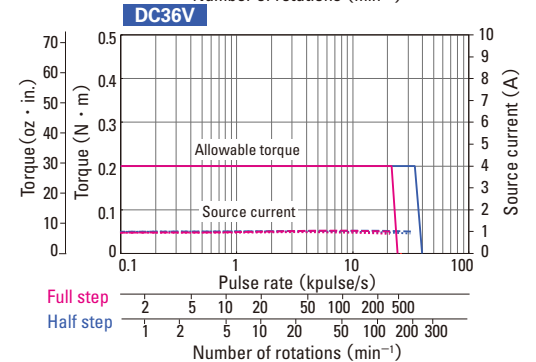
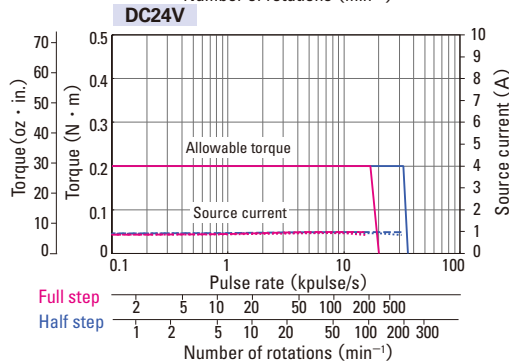

FD521S-GX20
FD521D-GX20

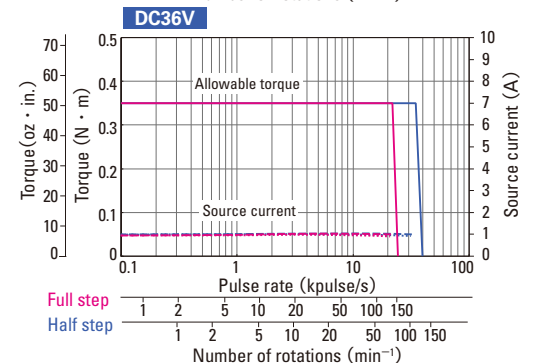
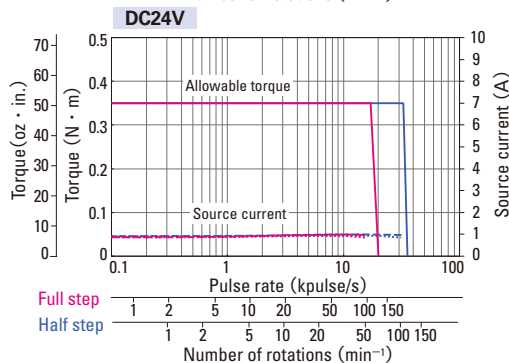

In motor+gear models, the gears may be damaged if allowable torque is exceeded. When selecting a motor, ensure that its allowable torque will not be exceeded. System configuration ▶ P.60 Set Model Configuration ▶ P.62 Motor dimensions ▶ P.102 Driver dimensions ▶ P.105 The data are measured under the drive condition of our company. The drive torque may very depending on the accuracy of customer-side equipment.

AC input Set model
Micro step

DC input Set model
Micro step

DC input Set model
Full / half step

Stepping Motor

Linear Actuator
Stepping Motor

Stepping motor for
vacuum environment

Dimensions

Spur gear model DC input Driver (Model number : FS1D140P10) + Motor with spur gear

Rated current : 0.75A/phase

Motor size		28mm sq. (1.10inch sq.)	
Motor + gear length		61.5mm (2.42inch)	61.5mm (2.42inch)
Single shaft	Set ordering model no.	FDF521S-GX30	FDF521S-GX50
	Corresponding motor model number	SH5281-72GXJ4	SH5281-72GXL4
Double shaft	Set ordering model no.	FDF521D-GX30	FDF521D-GX50
	Corresponding motor model number	SH5281-72GXJ1	SH5281-72GXL1
Allowable torque	N · m (OZ · in)	0.5 (70.80)	0.5 (70.80)
Rotor inertia	$\times 10^{-4}$ kg · m ² (OZ · in ²)	0.01 (0.05)	0.01 (0.05)
Basic step angle	DEG	0.024	0.0144
Gear ratio	-	1 : 30	1 : 50
Backlash	DEG	1.5	1.5
Allowable speed	min ⁻¹	100	60
Motor mass ^(Note1)	kg (lbs)	0.17 (0.37)	0.17 (0.37)
Allowable thrust load	N (lbs)	10 (2.25)	10 (2.25)
Allowable radial load ^(Note2)	N (lbs)	15 (3.38)	15 (3.38)

The directions of motor rotation and gear output axle rotation are the same for models with reduction ratio 1:3.6, 1:7.2, 1:20, 1:30 and 1:50 reduction ratios, and opposite for 1:10 reduction ratios.

(Note1) Driver mass ▶ P.79

(Note2) When load is applied at 1/3 length from output shaft edge.

Characteristics

Operating current : 0.75A/phase
Use the rubber coupling

Allowable torque Full step — Half step —
Source current (no load) Full step - - - Half step - - -

Source current (load applied) Full step ····· Half step ·····

FDF521S-GX30
FDF521D-GX30

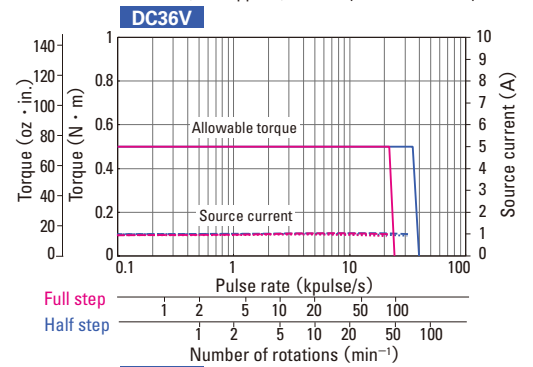
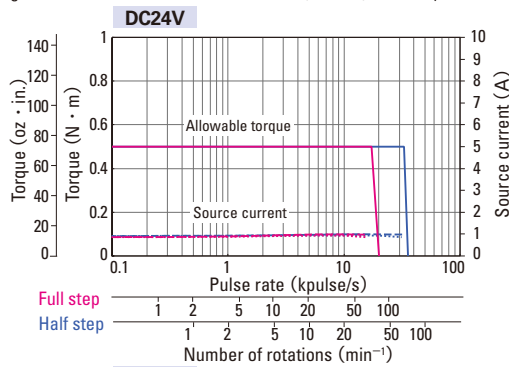

FDF521S-GX50
FDF521D-GX50

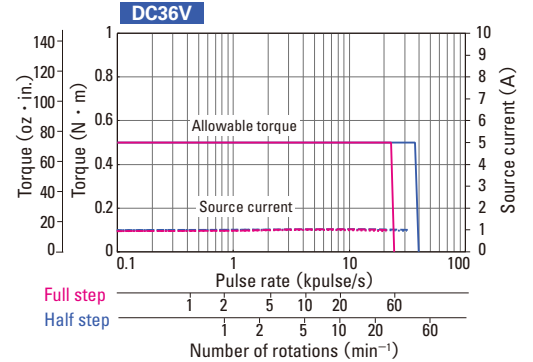
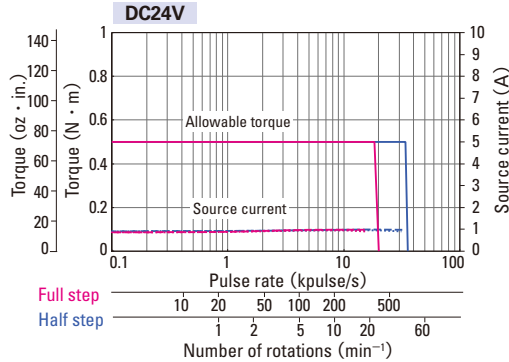

Harmonic gear model DC input Driver (Model number : FS1D140P10) + Harmonic gear motor

Rated current : 28mm sq.(1.10inch sq.) Motor 0.75A/phase, 42mm sq. (1.65inch sq.) to ^φ86mm (^φ3.39inch) Motor 1.4A/phase

Motor size		28mm sq. (1.10inch sq.)		42mm sq. (1.65inch sq.)	
Motor + gear length		70.7mm (2.78inch)	70.7mm (2.78inch)	73.5 mm (2.78inch)	73.5 mm (2.78inch)
Single shaft	Set ordering model no.	FD521S-HX50	FD521S-HX100	FD551S-HX30	FD551S-HX50
	Corresponding motor model number	SH5281-72HXL4	SH5281-72HXM4	103F5505-82HXJ5	103F5505-82HXL5
Double shaft	Set ordering model no.	FD521D-HX50	FD521D-HX100	FD551D-HX30	FD551D-HX50
	Corresponding motor model number	SH5281-72HXL1	SH5281-72HXM1	103F5505-82HXJ2	103F5505-82HXL2
Allowable torque	N · m (OZ · in)	1.5 (212.4)	2 (283.2)	2.2 (311.547)	3.5 (495.643)
Momentary allowable torque	N · m (OZ · in)	2.7 (382.4)	3.6 (509.8)	4.5 (637.3)	8.3 (1175.4)
Rotor inertia	$\times 10^{-4}$ kg · m ² (OZ · in ²)	0.013 (0.066)	0.013 (0.066)	0.042 (0.23)	0.042 (0.23)
Basic step angle	DEG	0.0144	0.0072	0.024	0.0144
Gear ratio	-	1 : 50	1 : 100	1 : 30	1 : 50
Hysteresis loss	Minute	-	-	3.6	2.4
Lost motion	Minute	0.4 to 3 ± 0.06N · m (0.85oz · in)	0.4 to 3 ± 0.08N · m (1.133oz · in)	-	-
Allowable speed	min ⁻¹	70	35	116	70
Motor mass ^(Note1)	kg (lbs)	0.22 (0.48)	0.22 (0.48)	0.43 (0.94)	0.43 (0.94)
Allowable thrust load	N (lbs)	100 (22.5)	100 (22.5)	1150 (258.75)	1150 (258.75)
Allowable radial load ^(Note2)	N (lbs)	160 (36)	160 (36)	275 (61.88)	275 (61.88)

Direction of gear output shaft are the opposite. (Note1) Driver mass ▶ P.79 (Note2) When load is applied at 1/3 length from output shaft edge.

Characteristics

Use the rubber coupling

FD521S-HX50 FD521D-HX50

Operating current : 0.75A/phase

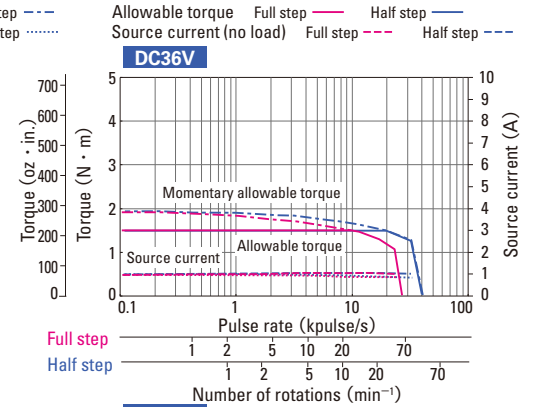
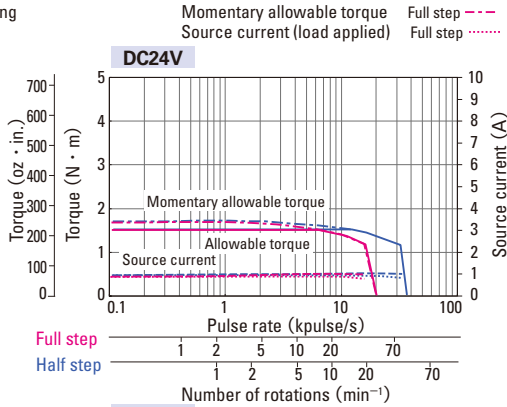

FD521S-HX100 FD521D-HX100

Operating current : 0.75A/phase

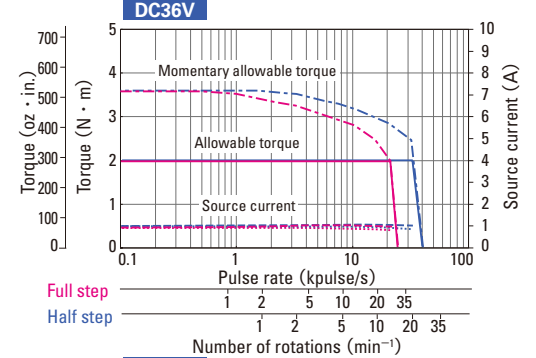
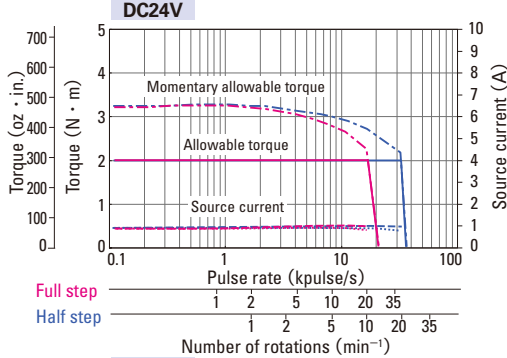

FD551S-HX30 FD551D-HX30

Operating current : 1.4A/phase

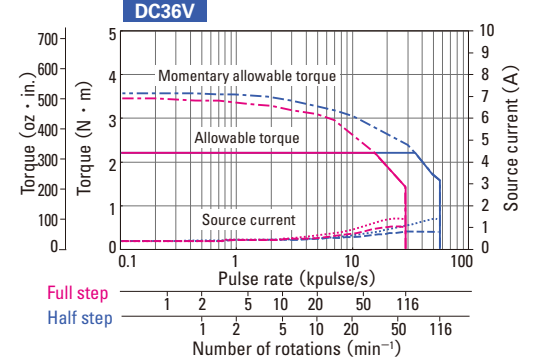
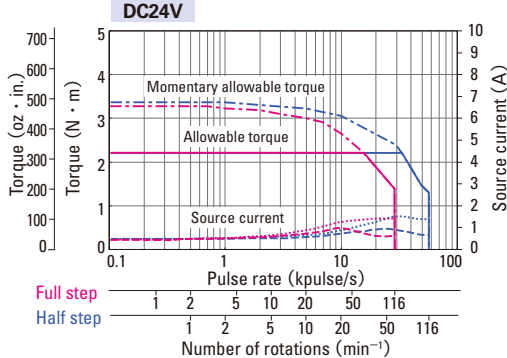

FD551S-HX50 FD551D-HX50

Operating current : 1.4A/phase

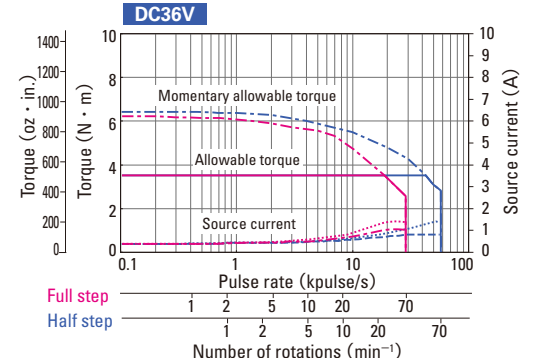
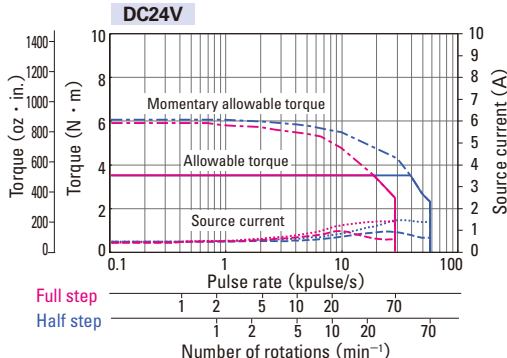

In motor+gear models, the gears may be damaged if allowable torque is exceeded. When selecting a motor, ensure that its momentary allowable torque will not be exceeded. System configuration ▶ P.60 Set Model Configuration ▶ P.62 Motor dimensions ▶ P.102 to 103 Driver dimensions ▶ P.105 The data are measured under the drive condition of our company. The drive torque may vary depending on the accuracy of customer-side equipment.

AC input Set model
Micro step

DC input Set model
Micro step

DC input Set model
Full / half step

Stepping Motor

Linear Actuator
Stepping Motor

Stepping motor for
vacuum environment

Dimensions

Harmonic gear model DC input Driver (Model number : FS1D140P10) + Harmonic gear motor

Rated current : 28mm sq. (1.10inch sq.) Motor 0.75A/phase, 42mm sq. (1.65inch sq.) to ϕ 86mm (ϕ 3.39inch) Motor 1.4A/phase

Motor size		42mm sq. (1.65inch sq.)	60mm sq. (2.36inch sq.)		ϕ 86mm (ϕ 3.39inch)
Motor + gear length		73.5 mm	113.5mm (XXXinch)	113.5mm (XXXinch)	144.15mm (XXXinch)
Single shaft	Set ordering model no.	FD551S-HX100	FD781S-HX50	FD781S-HX100	FD851S-HX50
	Corresponding motor model number	103F5505-82HXM5	103F7851-82HXL4	103F7851-82HXM4	103F8581-82HXL4
Double shaft	Set ordering model no.	FD551D-HX100	FD781D-HX50	FD781D-HX100	FD851D-HX50
	Corresponding motor model number	103F5505-82HXM2	103F7851-82HXL1	103F7851-82HXM1	103F8581-82HXL1
Allowable torque	N · m (OZ · in)	5 (708.061)	5.5 (778.8)	8 (1132.9)	25 (3540.2)
Momentary allowable torque	N · m (OZ · in)	11 (1557.7)	14 (1982.6)	20 (2832.2)	34 (4814.8)
Rotor inertia	$\times 10^{-4}$ kg · m ² (OZ · in ²)	0.0042 (0.02)	0.31 (1.695)	0.31 (1.695)	1.65 (9.02)
Basic step angle	DEG	0.0072	0.0144	0.0072	0.0144
Gear ratio	-	1 : 100	1 : 50	1 : 100	1 : 50
Hysteresis loss	Minute	2.4	-	-	-
Lost motion	Minute	-	0.4 to 3 \pm 0.28N · m (3.965oz · in)	0.4 to 3 \pm 0.4N · m (56.645oz · in)	0.4 to 3 \pm 1N · m (141.612oz · in)
Allowable speed	min ⁻¹	35	70	35	70
Motor mass ^(Note1)	kg (lbs)	0.42 (0.92)	1.2 (2.64)	1.2 (2.64)	3.3 (7.26)
Allowable thrust load	N (lbs)	1150 (258.75)	400 (90)	400 (90)	1400 (315)
Allowable radial load ^(Note2)	N (lbs)	275 (61.88)	360 (81)	360 (81)	1380 (310.5)

Direction of gear output shaft are the opposite. (Note1) Driver mass ▶ P.79 (Note2) When load is applied at 1/3 length from output shaft edge.

Characteristics

Operating current : 1.4A/phase
Use the rubber coupling

FD551S-HX100
FD551D-HX100

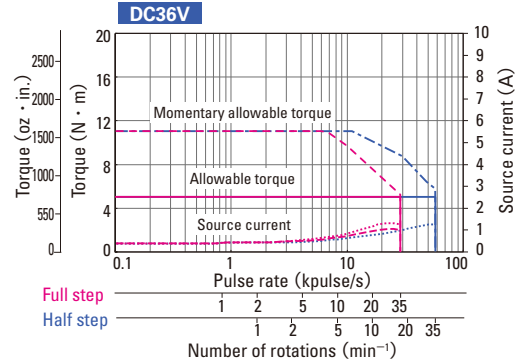
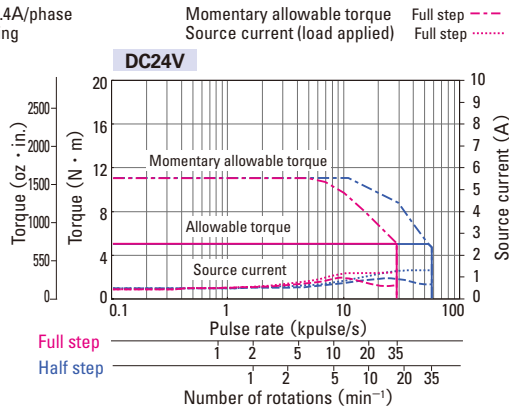

FD781S-HX50
FD781D-HX50

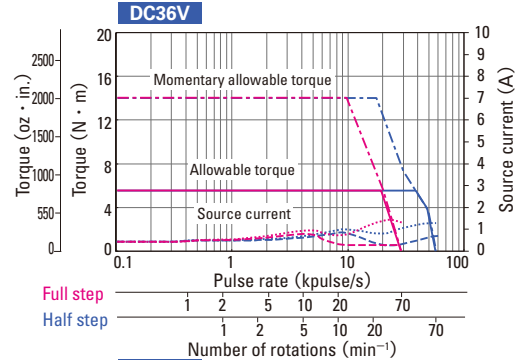
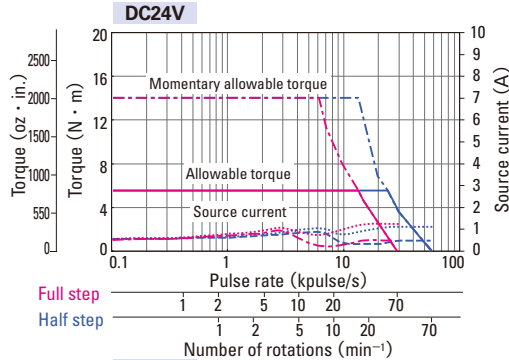

FD781S-HX100
FD781D-HX100

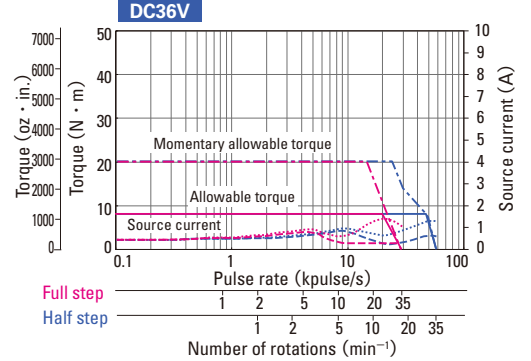
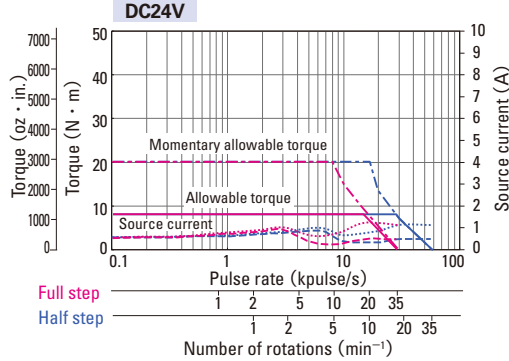

FD851S-HX50
FD851D-HX50

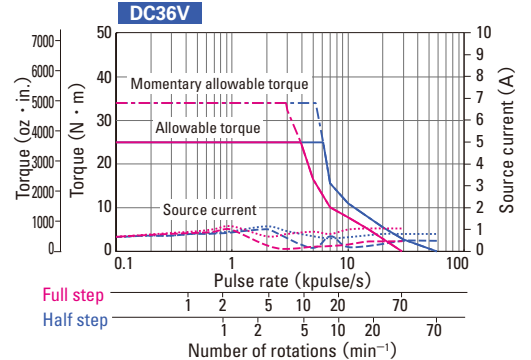
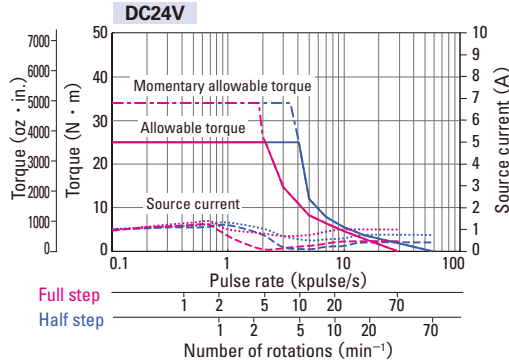

In motor+gear models, the gears may be damaged if allowable torque is exceeded. When selecting a motor, ensure that its momentary allowable torque will not be exceeded. System configuration ▶ P.60 Set Model Configuration ▶ P.62 Motor dimensions ▶ P.102 to 103 Driver dimensions ▶ P.105 The data are measured under the drive condition of our company. The drive torque may vary depending on the accuracy of customer-side equipment.

Motor size	φ 86mm (φ 3.39inch)	
Motor + gear length	144.15mm (5.68inch)	
Single shaft	Set ordering model no.	FDF851S-HX100
	Corresponding motor model number	103F8581-82HXM4
Double shaft	Set ordering model no.	FDF851D-HX100
	Corresponding motor model number	103F8581-82HXM1
Allowable torque	N · m (OZ · in)	41 (5805.9)
Momentary allowable torque	N · m (OZ · in)	59 (8355.1)
Rotor inertia	$\times 10^{-4}$ kg · m ² (OZ · in ²)	1.65 (9.02)
Basic step angle	DEG	0.0072
Gear ratio	-	1 : 100
Hysteresis loss	Minute	-
Lost motion	Minute	0.4 to 3 ± 1.2N · m (169.934oz · in)
Allowable speed	min ⁻¹	35
Motor mass ^(Note1)	kg (lbs)	3.3 (7.26)
Allowable thrust load	N (lbs)	1400 (315)
Allowable radial load ^(Note2)	N (lbs)	1380 (310.5)

Direction of gear output shaft are the opposite.

(Note1) Driver mass ▶ P.79

(Note2) When load is applied at 1/3 length from output shaft edge.

Characteristics

Operating current : 1.4A/phase
Use the rubber coupling

FDF851S-HX100
FDF851D-HX100

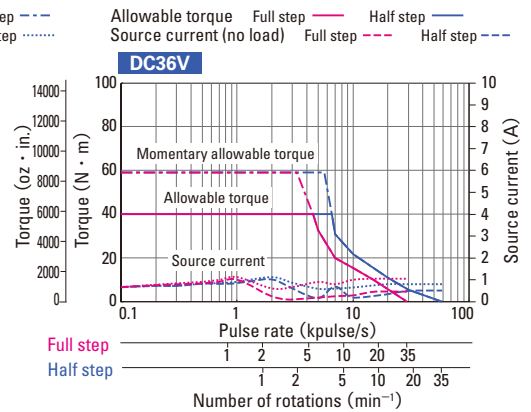
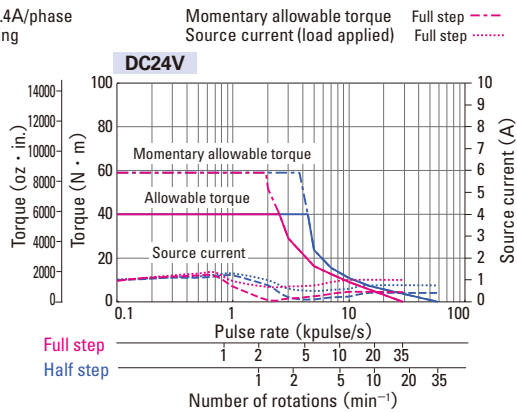

Electromagnetic brake model

DC input Driver (Model number : FS1D140P10) + Electromagnetic brake motor

Basic step angle : 0.72° Rated current : 1.4A/phase

Motor size		42mm sq. (1.65inch sq.)			60mm sq. (3.39inch sq.)
Motor + brake length		64.5mm	70.5mm	79.5mm	85.8mm
Set ordering model no.		FD551S-XB	FD552S-XB	FD554S-XB	FD781S-XB
Corresponding motor model number		103F5505-82XB41	103F5508-82XB41	103F5510-82XB41	103F7851-82XB41
Holding torque	N · m (OZ · in)	0.13 (8.4)	0.18 (25.49)	0.25 (35.4)	0.55 (77.88)
Rotor inertia	$\times 10^{-4}$ kg · m ² (OZ · in ²)	0.045 (0.25)	0.068 (0.37)	0.08 (0.44)	0.43 (2.35)
Motor mass ^(Note1)	kg (lbs)	0.38 (0.84)	0.43 (0.95)	0.52 (1.14)	0.94 (2.07)
Allowable thrust load	N (lbs)	10 (2.25)	10 (2.25)	10 (2.25)	20 (4.5)
Allowable radial load ^(Note2)	N (lbs)	35 (8.75)	35 (8.75)	35 (8.75)	80 (18)
Brake type		No excitation actuating type			No excitation actuating type
Electromagnetic brake	Power supply input	DC24V ± 5%			DC24V ± 5%
	Excitation current	0.08			0.25
	Power consumption	2			6
	Static friction torque	0.3 (42.48)			0.8 (113.29)
	Brake operating time	20			20
	Brake release time	30			30

(Note1) Driver mass ▶ P.79

(Note2) When load is applied at 1/3 length from output shaft edge.

Characteristics

Operating current : 1.4A/phase
Use the rubber coupling

Pull-out torque Full step — Half step — fs : Maximum self-start frequency when not loaded
Source current (no load) Full step - - - Half step - - - Source current (load applied) Full step ● Half step ●

FD551S-XB

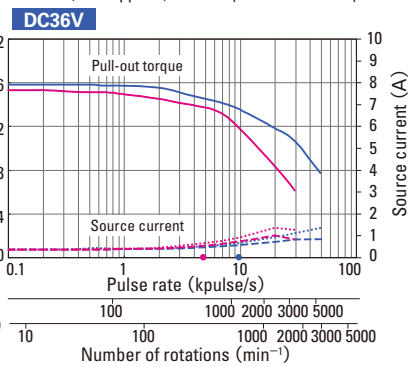
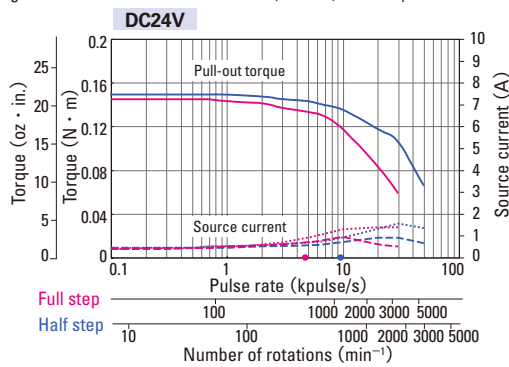

FD552S-XB

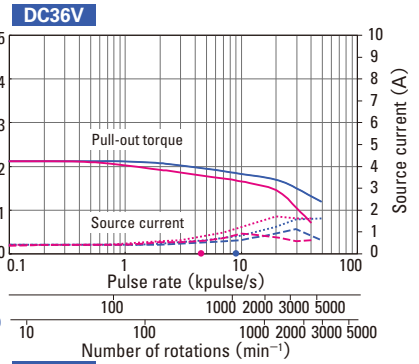
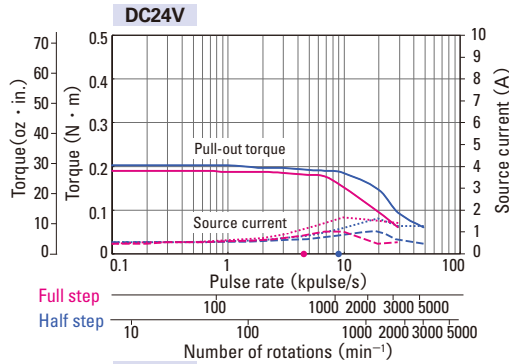

FD554S-XB

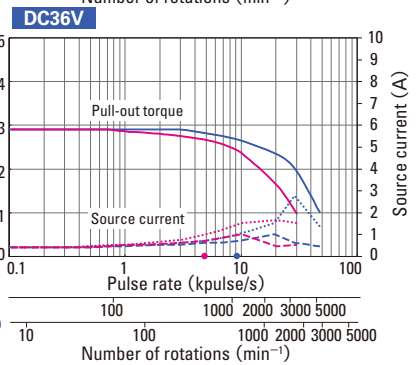
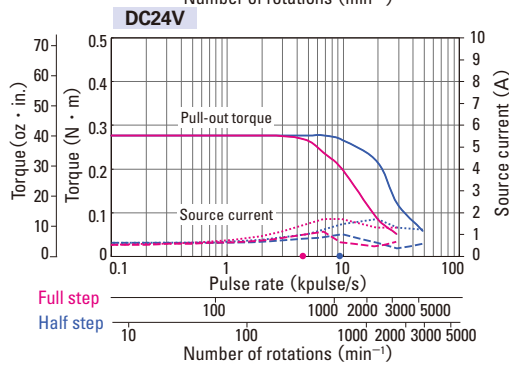

FD781S-XB

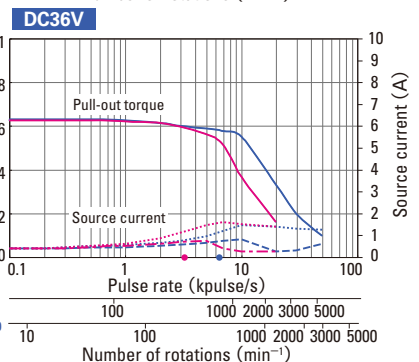
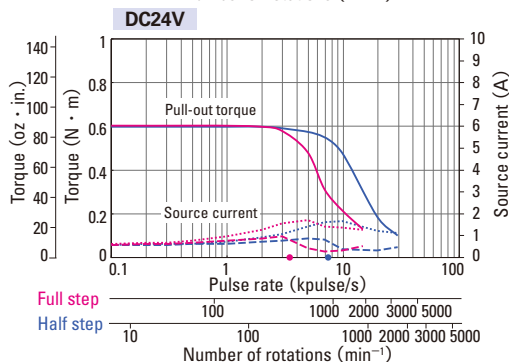

The electromagnetic brake only works when the motor is stopped, and cannot be used for braking. System configuration ▶ P.60 Set Model Configuration ▶ P.62 Motor dimensions ▶ P.104 Driver dimensions ▶ P.105 The data are measured under the drive condition of our company. The drive torque may very depending on the accuracy of customer-side equipment.

Motor size	60mm sq. (2.36inch sq.)		φ86mm (φ3.39inch)			
	94.5mm	126.7mm	116.7mm	146.8mm		
Motor + brake length						
Set ordering model no.	FD782S-XB	FD783S-XB	FD851S-XB	FD852S-XB		
Corresponding motor model number	103F7852-82XB41	103F7853-82XB41	103F8581-82XB41	103F8582-82XB41		
Holding torque	N · m (OZ · in)	0.87 (123.19)	1.67 (236.5)	2 (283.2)	4.02 (569.3)	
Rotor inertia	$\times 10^{-4} \text{kg} \cdot \text{m}^2 (\text{OZ} \cdot \text{in}^2)$	0.56 (3.06)	1 (5.47)	2.24 (12.25)	3.69 (20.18)	
Motor mass ^(Note1)	kg (lbs)	1.12 (2.46)	1.7 (3.74)	3.5 (7.7)	4.5 (9.9)	
Allowable thrust load	N (lbs)	20 (4.5)	20 (4.5)	60 (13.5)	60 (13.5)	
Allowable radial load ^(Note2)	N (lbs)	80 (18)	80 (18)	220 (49.5)	220 (49.5)	
Brake type	No excitation actuating type		No excitation actuating type			
Electromagnetic brake	Power supply input	V	DC24V ± 5%	DC24V ± 5%	DC24V ± 5%	DC24V ± 5%
	Excitation current	A	0.25	0.25	0.42	0.42
	Power consumption	W	6	6	10	10
	Static friction torque	N · m (OZ · in)	0.8 (113.29)	0.8 (113.29)	5 (708.061)	5 (708.061)
	Brake operating time	ms	20	20	20	20
	Brake release time	ms	30	30	50	50

(Note1) Driver mass ▶ P.79

(Note2) When load is applied at 1/3 length from output shaft edge.

Characteristics

Operating current : 1.4A/phase
Use the rubber coupling

Pull-out torque Full step — Half step — fs : Maximum self-start frequency when not loaded Full step ● Half step ●
Source current (no load) Full step - - - Half step - - - Source current (load applied) Full step Half step

FD782S-XB

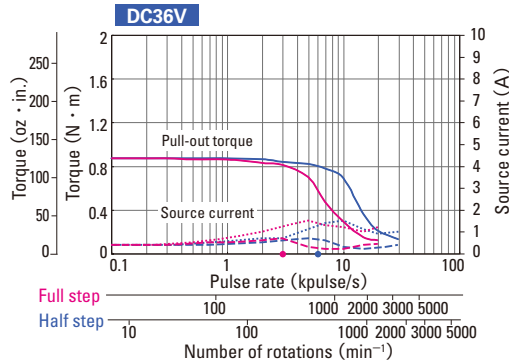
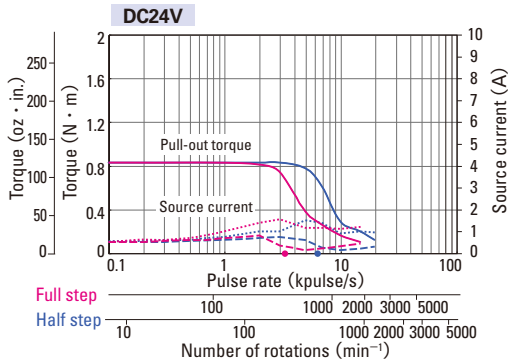

FD783S-XB

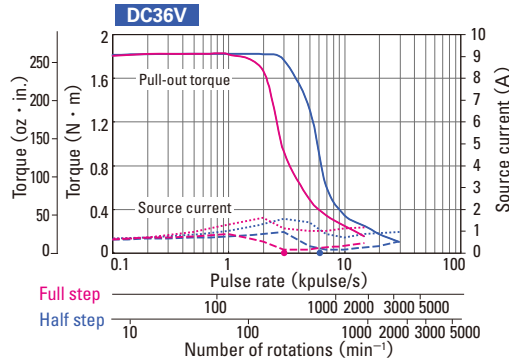
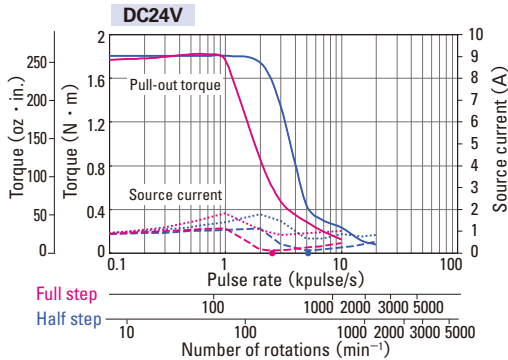

FD851S-XB

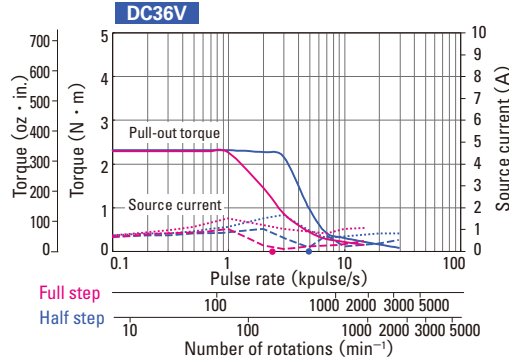
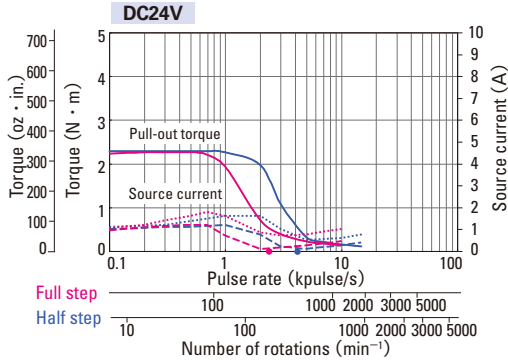

FD852S-XB

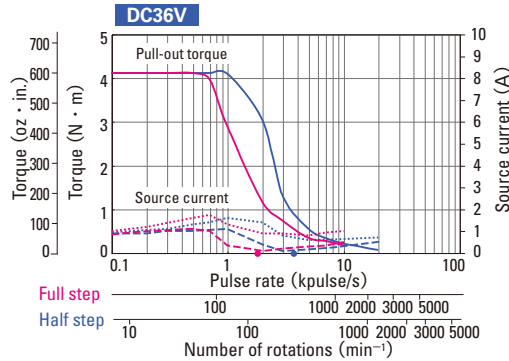
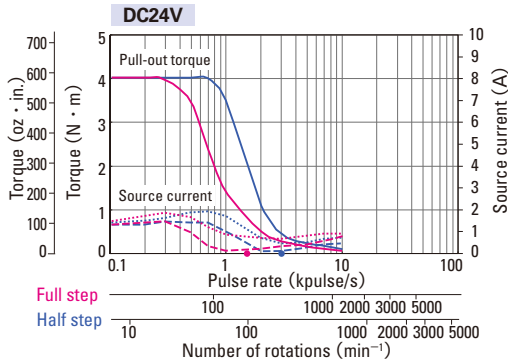

The electromagnetic brake only works when the motor is stopped, and cannot be used for braking. System configuration ▶ P.60 Set Model Configuration ▶ P.62 Motor dimensions ▶ P.104 Driver dimensions ▶ P.105 The data are measured under the drive condition of our company. The drive torque may very depending on the accuracy of customer-side equipment.

Motor specifications

General specifications

Model number	SH528 □	103F55 □□ / 103F785 □ / 103F858 □
Ambient operation temperature	- 10 to + 50°C (0 to + 40°C for harmonic gear model)	
Storage temperature	- 20 to + 65°C	
Ambient operation humidity	20 to 90% RH (no condensation)	
Storage humidity	5 to 95% RH (no condensation)	
Operation altitude	1000 m (3280 feet) MAX. above sea level	
Vibration resistance	Vibration frequency 10 to 500 Hz, total amplitude 1.52 mm (10 to 70 Hz), vibration acceleration 147 m/s ² (70 to 500 Hz), sweep time 15 min/cycle, 12 sweeps in each X, Y and Z direction.	
Impact resistance	490m/s ² of acceleration for 11 ms with half-sine wave applying three times for X, Y, and Z axes each, 18 times in total.	
Insulation class	Class B (+ 130°C)	
Withstand voltage	At normal ambient temperature and humidity, no failure with 500 V AC @50/60 Hz applied for one minute between motor winding and frame.	At normal ambient temperature and humidity, no failure with 1500 V AC @50/60 Hz applied for one minute between motor winding and frame.
Insulation resistance	At normal ambient temperature and humidity, 100 Mohm or more on megger with 500 V DC between motor winding and frame.	
Protection grade	IP40	
Wiring temperature increase	80K MAX. (Based on Sanyo Denki standard)	
Axial play ^(Note1)	0.075mm (0.002952inch) MAX., Load 4.4N (1lbs)	0.075mm (0.002952inch) MAX., Load 9N (2lbs)
Radial play ^(Note2)	0.025mm (0.00098inch) MAX., Load 4.4N (1lbs)	
Shaft runout	0.025mm (0.00098inch)	
Inserted part concentricity against shaft	φ 0.05mm (φ 0.00197inch)	φ 0.075mm (φ 0.00295inch)
Fitted surface angularity against shaft	0.1mm (0.00394inch)	0.1mm (0.00394inch)

(Note1) Axial play: Shaft displacement under axial load.

(Note2) Radial play: Shaft displacement under radial load applied 1/3rd of the length from the end of the shaft.

Internal wire connection

Connection Method: New Pentagon

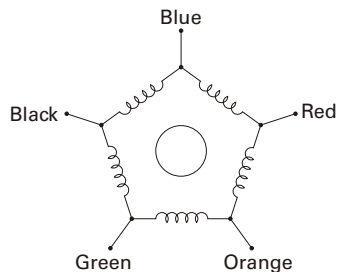

Direction of motor rotate

The direction of motor rotate is clockwise when viewed from the output shaft side at the direct current energization in the following order.

※ This is an instance of the standard model and the electromagnetic brake model.

As for some of the models with the gear, the direction of motor rotation is different, please make inquiries.

		Exciting order									
		1	2	3	4	5	6	7	8	9	10
Color of leads	Blue			+	+	+			-	-	-
	Red	-	-			+	+	+			-
	Orange		-	-				+	+	+	
	Green	+			-	-	-			+	+
	Black	+	+	+			-	-	-		

Driver specifications

General specifications

Basic specifications	Model number	FS1D140P10			
	Power supply	DC24V/36V ± 10%			
	Source current	3A			
	Environment	Protection class	Class III		
		Operation environment	Installation category (over-voltage category) : I (CE) Pollution level : 2		
		Ambient operation temperature	0 to + 50°C		
		Storage temperature	- 20 to + 70°C		
		Ambient operation humidity	35 to 85% RH (no condensation)		
		Storage humidity	10 to 90% RH (no condensation)		
		Operation altitude	1000 m (3280 feet) or less above sea level		
		Vibration resistance	Tested under the following conditions ; 5m/s ² , frequency range 10 to 55Hz, direction along X, Y and Z axes, for 2 hours each		
		Impact resistance	Not influenced at NDS-C-0110 standard section 3.2.2 division "C" .		
		Withstand voltage	Not influenced when 500V AC is applied between power input terminal and cabinet for one minute.		
Insulation resistance	10M ohm MIN. when measured with 500V DC megohmmeter between input terminal and cabinet.				
Mass	0.1kg				
Functions	Selection function	Step angle, pulse input method, step current, non-operating current, and operating current			
	Protection functions	Open phase protection, Voltage reduction in the main circuit power			
	LED indication	Power monitor, alarm (motor cable fault, switching element fault, main circuit voltage out of specified range)			
I/O signals	Command pulse input signal	Photo-coupler input system ; input resistance: 220 Ω ; input-signal "H" level : 4.0 to 5.5V ; input-signal "L" level : 0 to 0.5V, MAX. input frequency : 35kpulse/s			
	Power down input signal	Photo-coupler input system ; input resistance: 220 Ω ; input-signal "H" level : 4.0 to 5.5V ; input-signal "L" level : 0 to 0.5V			
	Input signal	Open collector output by photo coupler, output signal standard, Vce0 = 40V MAX., Ic = 10 mA MAX.			
	Output signal	Open collector output by photo coupler, output signal standard, Vce0 = 40V MAX., Ic = 10 mA MAX.			

Safety standards

	Directives	Category	Standard part	Name
CE (TÜV)	Low-voltage directives	—	EN61010-1	—
	EMC directives	Emission	EN55011-A	Terminal disturbance voltage
			EN55011-A	Electromagnetic radiation disturbance
		Immunity	EN61000-4-2	ESD (Electrostatic discharge)
			EN61000-4-3	RS (Radio-frequency amplitude modulated electromagnetic field)
			EN61000-4-4	Fast transients
	EN61000-4-6	Surges		
UL	Acquired standards	Standard part	File No.	
	UL	UL508C	E179775	
	UL for Canada (c-UL)			

- EMC characteristics may vary depending on the configuration of the users' control panel, which contains the driver or stepping motor, or the arrangement and wiring of other electrical devices.
- Validation test of driver has been performed for low-voltage EMC directives at TUV (TUV SUD Japan) for self-declaration of CE marking.

Driver Controls and Connectors

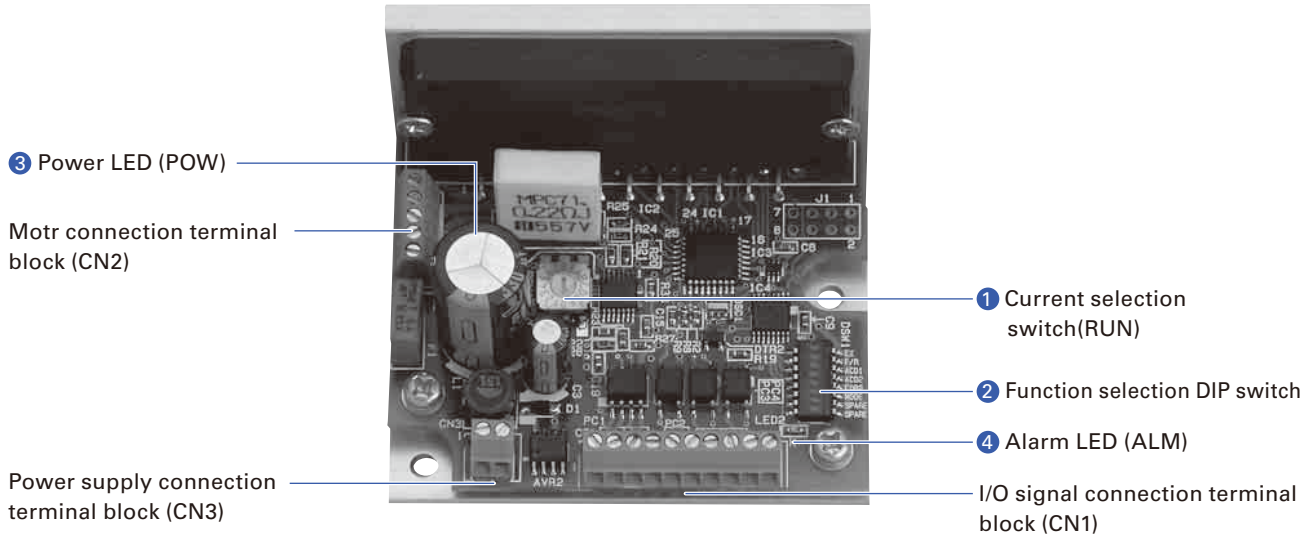

1 Current selection switch (RUN)

Enable to select operating current value to stepping motor.

Indication	0	1	2	3	4	5	6	7
Stepping motor current (A)	1.4	1.35	1.3	1.25	1.2	1.15	1.1	1.05
Indication	8	9	A	B	C	D	E	F
Stepping motor current (A)	1.0	0.95	0.9	0.85	0.8	0.75	0.7	0.65

The factory default value is F(0.65A).

Please check the rated current of the motor to be combined before selecting the operation current.

2 Function selection DIP switch

Selects an appropriate function for specification.

Factory default settings

	OFF	ON	
EX	<input type="checkbox"/>	<input type="checkbox"/>	OFF Half step
F/R	<input type="checkbox"/>	<input type="checkbox"/>	OFF 2-input mode (CW, CCW pulse-input method)
ACD1	<input type="checkbox"/>	<input type="checkbox"/>	OFF Stopping current : 40% of driving current
ACD2	<input type="checkbox"/>	<input type="checkbox"/>	
EORG	<input type="checkbox"/>	<input type="checkbox"/>	OFF Phase origin
MODE	<input type="checkbox"/>	<input type="checkbox"/>	OFF Reservation : Don't turn it ON.
SPARE	<input type="checkbox"/>	<input type="checkbox"/>	
SPARE	<input type="checkbox"/>	<input type="checkbox"/>	

Step angle selection (EX)

Selects the basic step angle.

EX	Exciting mode
ON	Full step (0.72° /pulse)
OFF	Half step (0.36° /pulse)

Input method select (F/R)

Selects input pulse type.

F/R	Input pulse type
ON	1 input (CK, U/D)
OFF	2 input (CW, CCW)

Current adjustment at operation halt (ACD1, ACD2)

Selects the value of the motor current during stand-still.

ACD2	ACD1	Motor current
ON	ON	100% of driving current
ON	OFF	60% of driving current
OFF	ON	50% of driving current
OFF	OFF	40% of driving current

Initial configuration of factory shipment is set to 40% of rated value.

Driver and motor should be operated at around 50% of rated value to reduce heat.

Excitation select (EORG)

The excitation phase when the power supply is turned on is selected.

EORG	Original excitation phase
ON	Excitation phase at power shut off
OFF	Phase origin

By turning on the EORG, excitation phase when power OFF will be saved. Therefore, there will be no shaft displacement when turning the power ON.

3 Power LED (POW)

Lights up when main circuit power supply is switched on.

Indication	Explanation
"POW" is displayed.	Main circuit power supply is switched on.

4 Alarm LED (ALM)

Lights up during alarm conditions.

Indication	Explanation
"ALM" is displayed.	Motor cable is broken, or switching element in driver is faulty. The main circuit voltage is out of specifications range (Less than DC19V).

When "ALM" is displayed, the winding current of the stepping motor is cut off and it is in a " non-excitation" state. At the same time, an output signal (photocoupler ON) is transmitted from the alarm output terminal (AL) to an external source. When the alarm circuit is operating, this state is maintained until it is reset by switching on the power supply again. When an alarm condition has occurred, please take corrective actions to rectify the cause of the alarm before switching on the power supply again.

Connections and Signals

External wiring diagram

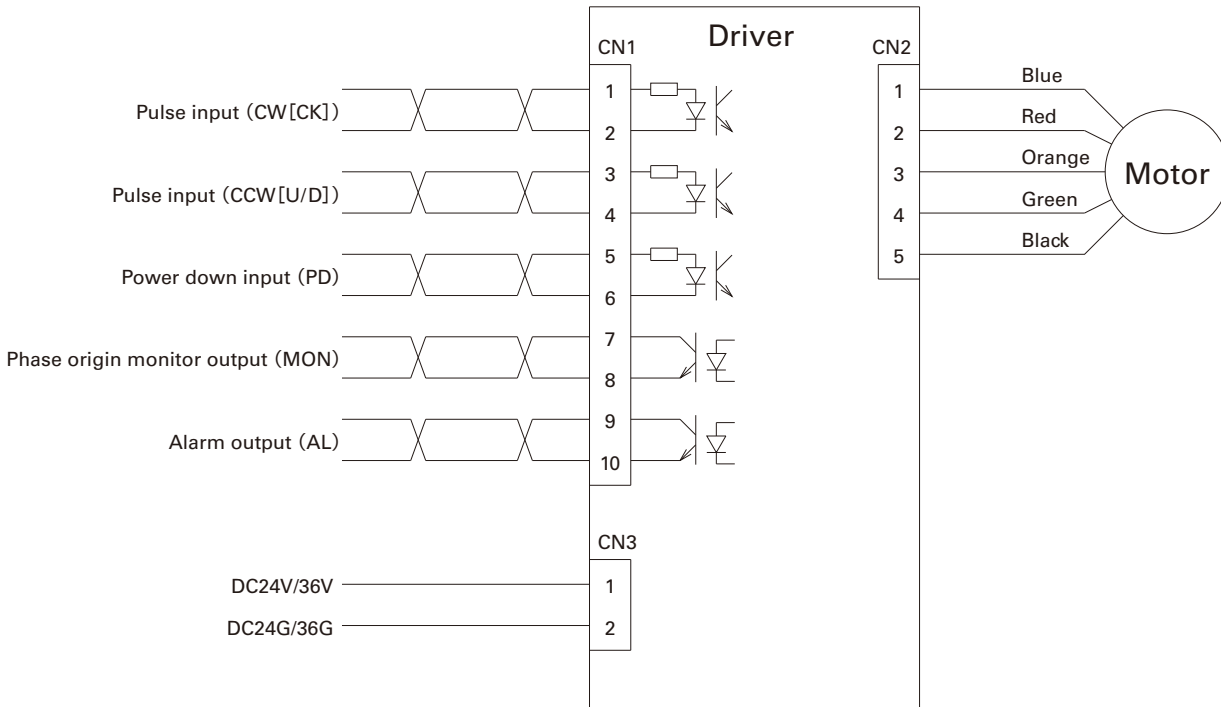

Applicable wire sizes

Part	size	Allowable wire length
Power supply	AWG22 (0.3mm ²)	2m max.
Input/output signal	AWG24 (0.2mm ²) to AWG22 (0.3mm ²)	2m max.
Motor	AWG22 (0.3mm ²)	Less than 3m

When bundling wire together or running wires through duct, take reduction rate of each wire allowable current into consideration.
 When ambient temperature is relatively high, wire product lifetime is reduced due to heat deterioration.
 In this case, please use Heat resistant Indoor PVC (HIV).

Specification summary of CN1 I/O signal

Signal name	CN1 Pin number	Function
CW pulse input (standard)	1	When using "2-input mode"
	2	Drive pulse for the CW direction rotation is input.
Pulse column input	1	When using "Pulse and direction mode"
	2	Drive pulse train for the stepping motor rotation is input.
CCW pulse input (standard)	3	When using "2-input mode"
	4	Drive pulse for the CCW direction rotation is input.
Rotation direction input	3	The rotation direction signal of stepping motor is input for the "Pulse and direction mode" .
	4	Internal photocoupler ON ... CW direction Internal photocoupler OFF ... CCW direction
Power down input	5	Inputting the PD signal cuts OFF the current flowing through the stepping motor.
	6	internal photocoupler ON ... PD function enabled internal photocoupler OFF ... PD function disabled
Phase origin monitor output	7	It is turned ON when the excitation phase is at the origin (in the state when the power is turned ON)
	8	It is turned ON once per 10 pulses when setting to HALF step. It is turned ON once per 20 pulses when setting to FULL step.
Alarm output	9	The signal is externally output (photocoupler ON) when one of several alarm circuits operates in the PM driver.
	10	At this time,the stepping motor is in the unexcited state.

The CW rotation direction of stepping motor means the clockwise direction rotation as viewed from the output shaft side (ange side).
 The CCW rotation direction means the counterclockwise direction rotation as viewed from the output shaft side (ange side).

Input circuit configuration of CW (CK), CCW (U/D)

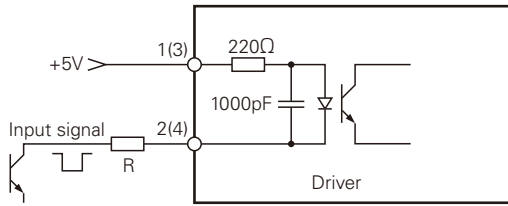

- Pulse duty 50% MAX.
- Maximum input frequency: 35kpulse/s
- When the crest value of the input signal exceeds 5V, use the external limit resistance R to limit the input current to approximately 15mA.

Input signal specification

<Photo coupler>

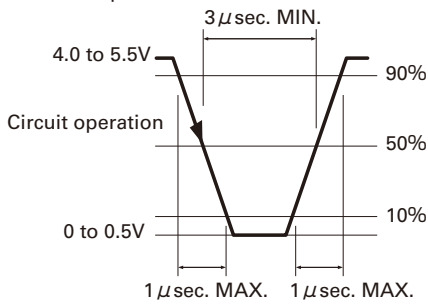

Timing of command pulse

2 input type (CW, CCW)

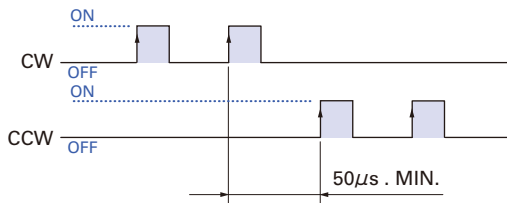

- The shaded regions in the diagram indicate when the internal photocoupler is ON. The internal circuit (motor) is active at the rising edge of the photocoupler pulses.
- To apply pulse to CW, set CCW side internal photo coupler to "OFF".
- To apply pulse to CCW, set CW side internal photo coupler to "OFF".

1 input type (CK, U/D)

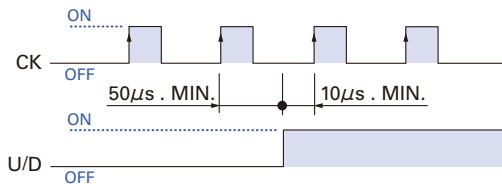

- The shaded regions in the diagram indicate when the internal photocoupler is ON. The internal circuit (motor) is active at the rising edge of the CK-side photocoupler pulses.
- Switching of U/D input signal must be done while CK side internal photo coupler is "OFF".

Input circuit configuration of PD

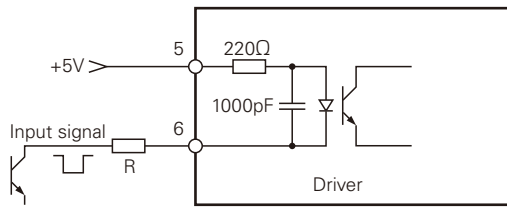

- If the peak value exceeds 5V, set the input current to approx. 15mA using the external limit resistance R.

Output signal configuration of MON, AL

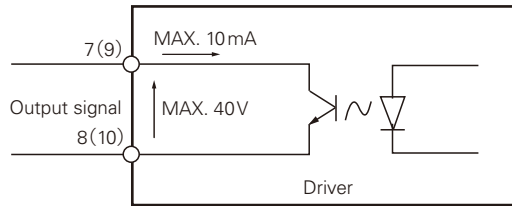

MON output

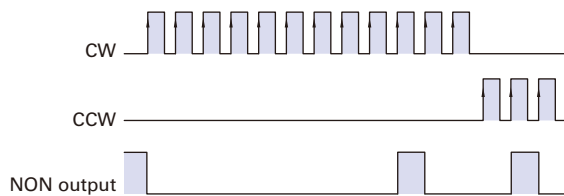

Ex.) Setting when number of division is 1 (full step)

- Photo coupler at phase origin of motor excitation (status at power on) is set to "ON"
- Output from MON is set to on at every 7.2 degrees of motor output shaft from phase origin.

Stepping Motor

Allowable load/Internal wire connection/Direction of motor rotate ▶ P.93 General specifications ▶ P.94 Motor dimensions ▶ P.97 to 100

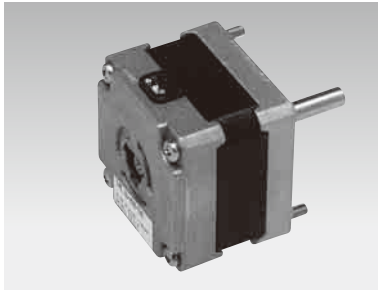

39mm sq. (1.54inch sq.)

0.36° /step
Motor with leads

Model number		Holding torque at 5-phase energization	Rated current	Wiring resistance	Winding inductance	Rotor inertia	Mass(Weight)
Single shaft	Double shaft	[N · m (oz · in) MIN.]	A/phase	Ω /phase	mH/phase	[× 10 ⁻⁴ kg · m ² (oz · in ²)]	kg (lbs)
103-4505-7040	103-4505-7010	0.078 (11.05)	0.75	2	1.97	0.0182 (0.10)	0.17 (0.37)
103-4507-7040	103-4507-7010	0.108 (15.29)	0.75	2.35	3.8	0.024 (0.13)	0.2 (0.44)
103-4510-7040	103-4510-7010	0.167 (23.65)	0.75	3	6.2	0.036 (0.20)	0.3 (0.66)

Characteristics

103-4505-7040
103-4505-7010

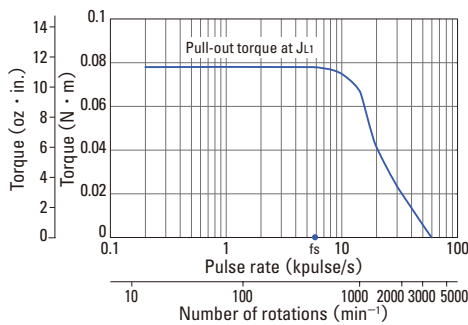

Constant current circuit
Source voltage : DC24V · operating current : 0.75A/phase
5-phase excitation (full step)
JL1= [0.33 × 10⁻⁴kg · m² (1.80 oz · in²) use the rubber coupling]
fs: Maximum self - start frequency when not loaded

103-4507-7040
103-4507-7010

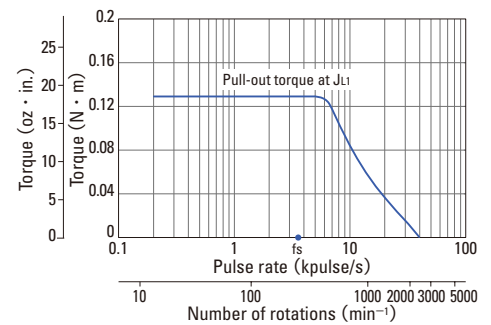

Constant current circuit
Source voltage : DC24V · operating current : 0.75A/phase
5-phase excitation (full step)
JL1= [0.33 × 10⁻⁴kg · m² (1.80 oz · in²) use the rubber coupling]
fs: Maximum self - start frequency when not loaded

103-4510-7040
103-4510-7010

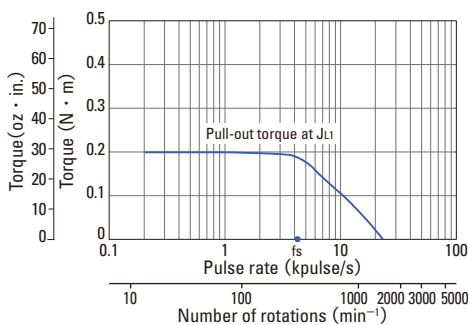

Constant current circuit
Source voltage : DC24V · operating current : 0.75A/phase
5-phase excitation (full step)
JL1= [0.94 × 10⁻⁴kg · m² (5.14 oz · in²) use the rubber coupling]
fs: Maximum self - start frequency when not loaded



φ 60mm (φ 2.36inch)

0.45° /step

Motor with leads

Model number		Holding torque at 5-phase energization	Rated current	Wiring resistance	Winding inductance	Rotor inertia	Mass(Weight)
Single shaft	Double shaft	[N · m (oz · in) MIN.]	A/phase	Ω /phase	mH/phase	[× 10 ⁻⁴ kg · m ² (oz · in ²)]	kg (lbs)
103-7566-7041	103-7566-7011	0.91 (128.9)	0.75	4.8	23	0.235 (1.28)	1.1 (2.43)

Characteristics

103-7566-7041
103-7566-7011

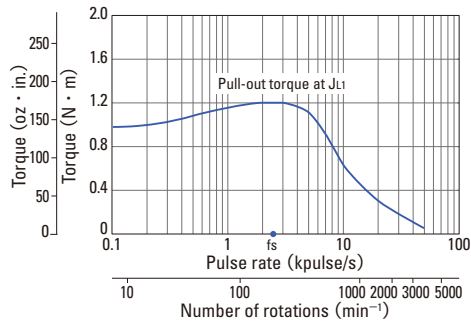

Constant current circuit
Source voltage : AC100V · operating current : 0.75A/phase
5-phase excitation (full step)
JL1= [2.6 × 10⁻⁴kg · m² (14.22 oz · in²) use the rubber coupling]
fs: Maximum self - start frequency when not loaded



28mm sq. (1.10inch sq.)

0.72° /step

Motor with leads

Model number		Holding torque at 5-phase energization	Rated current	Wiring resistance	Winding inductance	Rotor inertia	Mass(Weight)
Single shaft	Double shaft	[N · m (oz · in) MIN.]	A/phase	Ω /phase	mH/phase	[× 10 ⁻⁴ kg · m ² (oz · in ²)	kg (lbs)
SH5281-3041	SH5281-3011	0.045 (6.37)	0.35	4.5	2.7	0.01 (0.05)	0.11 (0.24)
SH5281-7041	SH5281-7011	0.041 (5.81)	0.75	1.05	0.44	0.01 (0.05)	0.11 (0.24)
SH5285-3041	SH5285-3011	0.085 (12.04)	0.35	5	3.5	0.022 (0.12)	0.2 (0.44)
SH5285-7041	SH5285-7011	0.078 (11.05)	0.75	1.15	0.64	0.022 (0.12)	0.2 (0.44)

Characteristics

SH5281-3041
SH5281-3011

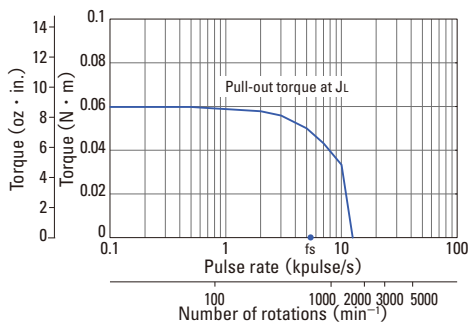

Constant current circuit
Source voltage : DC12V · operating current : 0.35A/phase
5-phase excitation (full step)
 $J^L = [0.01 \times 10^{-4} \text{kg} \cdot \text{m}^2 (0.05 \text{oz} \cdot \text{in}^2) \text{ pulley balancer system}]$
fs: Maximum self - start frequency when not loaded

SH5281-7041
SH5281-7011

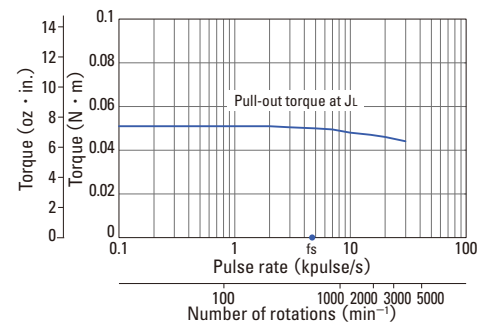

Constant current circuit
Source voltage : DC24V · operating current : 0.75A/phase
5-phase excitation (full step)
 $J^L = [0.01 \times 10^{-4} \text{kg} \cdot \text{m}^2 (0.05 \text{oz} \cdot \text{in}^2) \text{ pulley balancer system}]$
fs: Maximum self - start frequency when not loaded

SH5285-3041
SH5285-3011

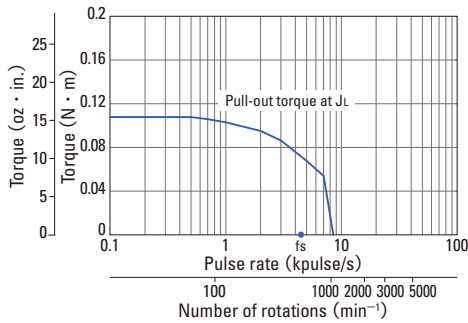

Constant current circuit
Source voltage : DC12V · operating current : 0.35A/phase
5-phase excitation (full step)
 $J^L = [0.01 \times 10^{-4} \text{kg} \cdot \text{m}^2 (0.05 \text{oz} \cdot \text{in}^2) \text{ pulley balancer system}]$
fs: Maximum self - start frequency when not loaded

SH5285-7041
SH5285-7011

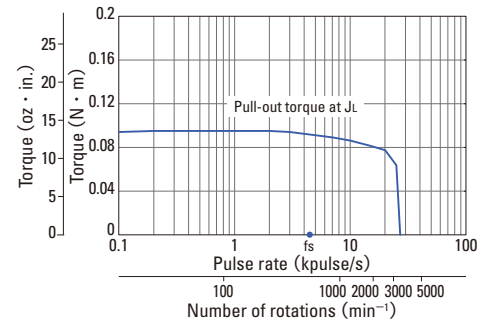

Constant current circuit
Source voltage : DC24V · operating current : 0.75A/phase
5-phase excitation (full step)
 $J^L = [0.01 \times 10^{-4} \text{kg} \cdot \text{m}^2 (0.05 \text{oz} \cdot \text{in}^2) \text{ pulley balancer system}]$
fs: Maximum self - start frequency when not loaded

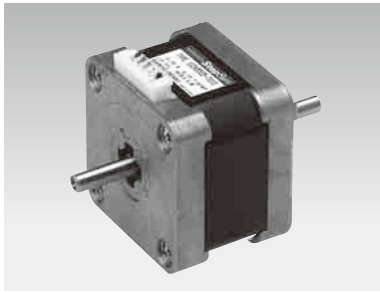

42mm sq. (1.65inch sq.)

0.72° /step

Motor with leads

Model number		Holding torque at 5-phase energization	Rated current	Wiring resistance	Winding inductance	Rotor inertia	Mass(Weight)
Single shaft	Double shaft	[N · m (oz · in) MIN.]	A/phase	Ω /phase	mH/phase	[× 10 ⁻⁴ kg · m ² (oz · in ²)]	kg (lbs)
103H5505-7040	103H5505-7010	0.127 (17.98)	0.75	1.45	1.2	0.03 (0.16)	0.23 (0.50)
103H5508-7040	103H5508-7010	0.176 (24.92)	0.75	1.6	1.8	0.053 (0.29)	0.28 (0.62)
103H5510-7040	103H5510-7010	0.255 (36.11)	0.75	2.2	2.2	0.065 (0.36)	0.37 (0.82)

Characteristics

103H5505-7040
103H5505-7010

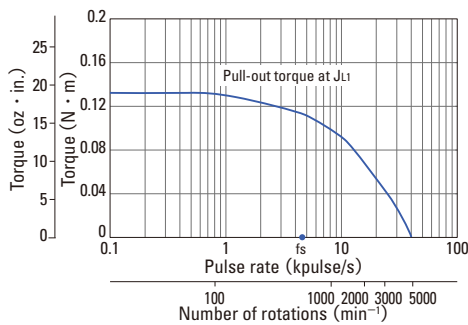

Constant current circuit
Source voltage : DC24V · operating current : 0.75A/phase
5-phase excitation (full step)
JL1= [0.94 × 10⁻⁴kg · m² (5.14 oz · in²) use the rubber coupling]
fs: Maximum self - start frequency when not loaded

103H5508-7040
103H5508-7010

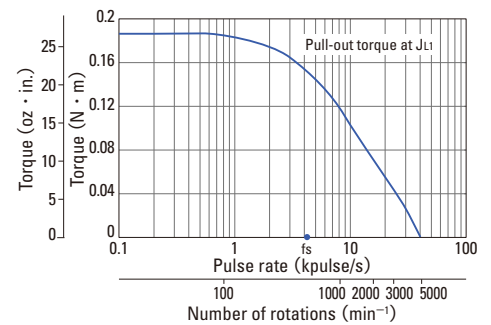

Constant current circuit
Source voltage : DC24V · operating current : 0.75A/phase
5-phase excitation (full step)
JL1= [0.94 × 10⁻⁴kg · m² (5.14 oz · in²) use the rubber coupling]
fs: Maximum self - start frequency when not loaded

103H5510-7040
103H5510-7010

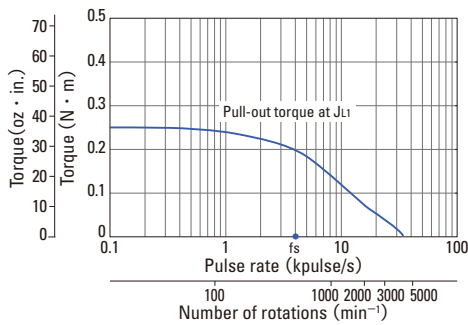

Constant current circuit
Source voltage : DC24V · operating current : 0.75A/phase
5-phase excitation (full step)
JL1= [0.94 × 10⁻⁴kg · m² (5.14 oz · in²) use the rubber coupling]
fs: Maximum self - start frequency when not loaded



50mm sq. (1.97inch sq.)

0.72° /step

Motor with leads

Model number		Holding torque at 5-phase energization	Rated current	Wiring resistance	Winding inductance	Rotor inertia	Mass(Weight)
Single shaft	Double shaft	[N · m (oz · in) MIN.]	A/phase	Ω /phase	mH/phase	[× 10 ⁻⁴ kg · m ² (oz · in ²)]	kg (lbs)
103H6500-7041	103H6500-7011	0.235 (33.28)	0.75	2	4	0.057 (0.31)	0.38 (0.84)
103H6500-8041	103H6500-8011	0.225 (31.86)	1.5	0.47	0.85	0.057 (0.31)	0.38 (0.84)
103H6501-7041	103H6501-7011	0.39 (55.23)	0.75	2.6	5.6	0.105 (0.57)	0.44 (0.97)
103H6501-8041	103H6501-8011	0.39 (55.23)	1.5	0.65	1.45	0.105 (0.57)	0.44 (0.97)

Characteristics

103H6500-7041
103H6500-7011

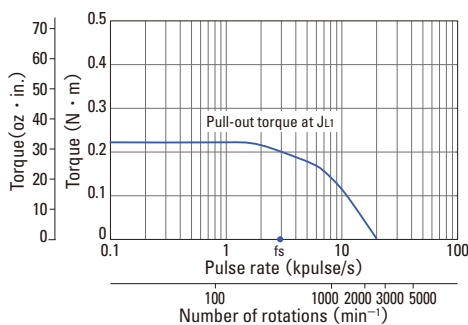

Constant current circuit
Source voltage : DC24V · operating current : 0.75A/phase
5-phase excitation (full step)
JL1= [0.94 × 10⁻⁴kg · m² (5.14 oz · in²) use the rubber coupling]
fs: Maximum self - start frequency when not loaded

103H6500-8041
103H6500-8011

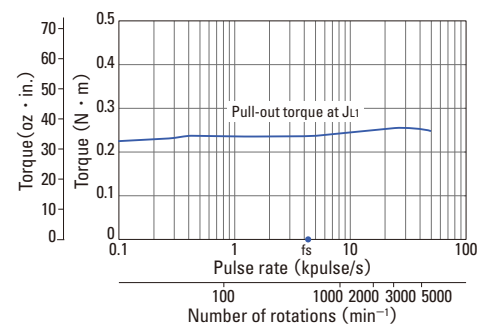

Constant current circuit
Source voltage : AC100V · operating current : 1.5A/phase
5-phase excitation (full step)
JL1= [0.94 × 10⁻⁴kg · m² (5.14 oz · in²) use the rubber coupling]
fs: Maximum self - start frequency when not loaded

103H6501-7041
103H6501-7011

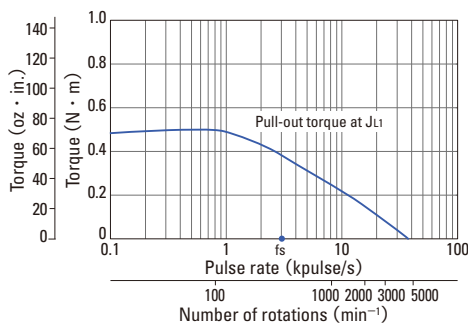

Constant current circuit
Source voltage : DC24V · operating current : 0.75A/phase
5-phase excitation (full step)
JL1= [0.94 × 10⁻⁴kg · m² (5.14 oz · in²) use the rubber coupling]
fs: Maximum self - start frequency when not loaded

103H6501-8041
103H6501-8011

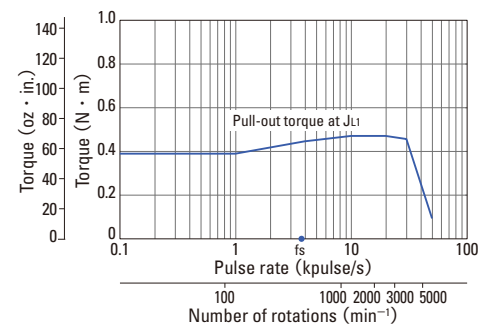

Constant current circuit
Source voltage : AC100V · operating current : 1.5A/phase
5-phase excitation (full step)
JL1= [0.94 × 10⁻⁴kg · m² (5.14 oz · in²) use the rubber coupling]
fs: Maximum self - start frequency when not loaded

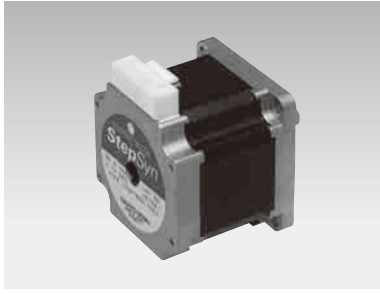

60mm sq. (2.36inch sq.)

0.72° /step
Motor with connector

Model number		Holding torque at 5-phase energization	Rated current	Wiring resistance	Winding inductance	Rotor inertia	Mass(Weight)
Single shaft	Double shaft	[N · m (oz · in) MIN.]	A/phase	Ω /phase	mH/phase	[× 10 ⁻⁴ kg · m ² (oz · in ²)]	kg (lbs)
103H7851-7051	103H7851-7021	0.65 (92.0)	0.75	2.75	4.75	0.275 (1.50)	0.6 (1.32)
103H7851-8051	103H7851-8021	0.65 (92.0)	1.5	0.64	1.2	0.275 (1.50)	0.6 (1.32)
103H7852-7051	103H7852-7021	0.98 (138.8)	0.75	3.4	7.75	0.4 (2.19)	0.78 (1.72)
103H7852-8051	103H7852-8021	0.98 (138.8)	1.5	0.8	2	0.4 (2.19)	0.78 (1.72)
103H7853-7051	103H7853-7021	1.86 (263.4)	0.75	5.5	15	0.84 (4.59)	1.36 (3.00)
103H7853-8051	103H7853-8021	1.86 (263.4)	1.5	1.28	3.85	0.84 (4.59)	1.36 (3.00)

Optional Accessories : motor cable model number : 4837847-1

Characteristics

103H7851-7051
103H7851-7021

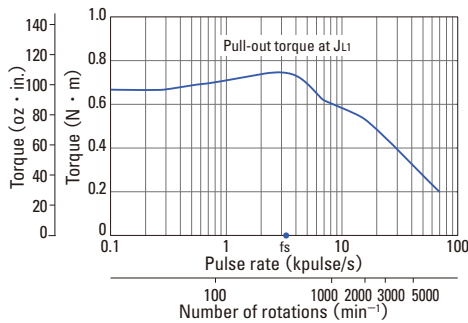

Constant current circuit
Source voltage : AC100V · operating current : 0.75A/phase
5-phase excitation (full step)
JL1= [0.94 × 10⁻⁴kg · m² (5.15 oz · in²) use the rubber coupling]
fs: Maximum self - start frequency when not loaded

103H7851-8051
103H7851-8021

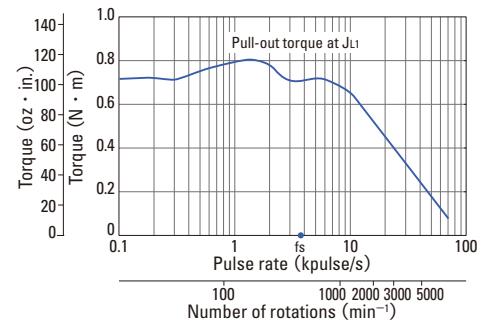

Constant current circuit
Source voltage : AC100V · operating current : 1.5A/phase
5-phase excitation (full step)
JL1= [2.6 × 10⁻⁴kg · m² (40.46 oz · in²) use the rubber coupling]
fs: Maximum self - start frequency when not loaded

103H7852-7051
103H7852-7021

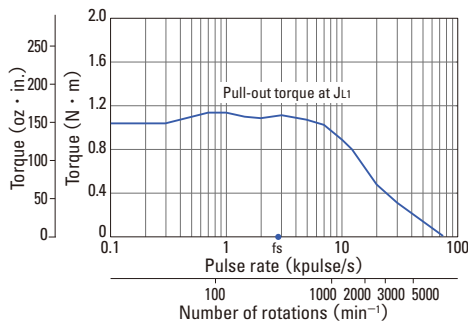

Constant current circuit
Source voltage : AC100V · operating current : 0.75A/phase
5-phase excitation (full step)
JL1= [2.6 × 10⁻⁴kg · m² (40.46 oz · in²) use the rubber coupling]
fs: Maximum self - start frequency when not loaded

103H7852-8051
103H7852-8021

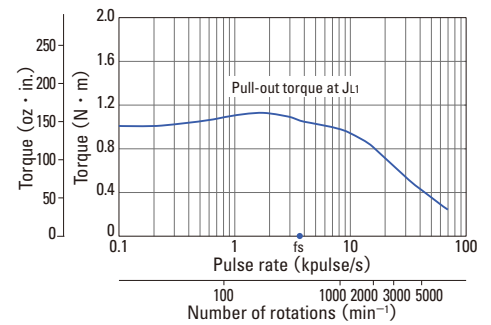

Constant current circuit
Source voltage : AC100V · operating current : 1.5A/phase
5-phase excitation (full step)
JL1= [2.6 × 10⁻⁴kg · m² (5.14 oz · in²) use the rubber coupling]
fs: Maximum self - start frequency when not loaded

103H7853-7051
103H7853-7021

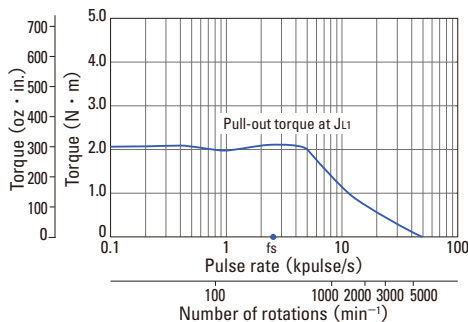

Constant current circuit
Source voltage : AC100V · operating current : 0.75A/phase
5-phase excitation (full step)
JL1= [7.4 × 10⁻⁴kg · m² (14.22 oz · in²) use the rubber coupling]
fs: Maximum self - start frequency when not loaded

103H7853-8051
103H7853-8021

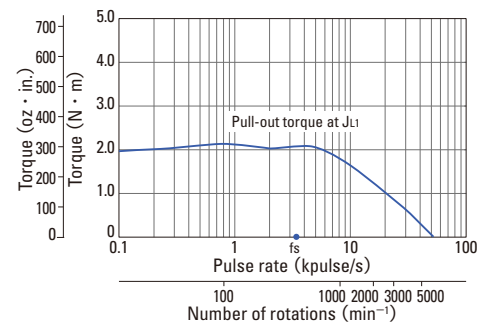

Constant current circuit
Source voltage : AC100V · operating current : 1.5A/phase
5-phase excitation (full step)
JL1= [7.4 × 10⁻⁴kg · m² (40.46 oz · in²) use the rubber coupling]
fs: Maximum self - start frequency when not loaded

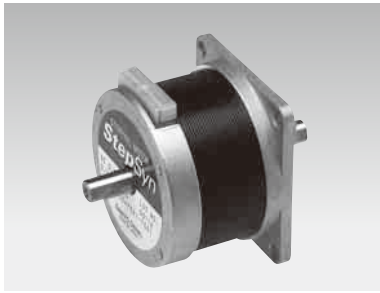

φ 60mm (φ 2.36inch)

0.72° /step

Motor with leads

Model number		Holding torque at 5-phase energization	Rated current	Wiring resistance	Winding inductance	Rotor inertia	Mass(Weight)
Single shaft	Double shaft	[N · m (oz · in) MIN.]	A/phase	Ω /phase	mH/phase	[× 10 ⁻⁴ kg · m ² (oz · in ²)	kg (lbs)
103H7521-7051	103H7521-7021	0.46 (65.1)	0.75	2.4	4.3	0.148 (0.81)	0.51 (1.12)
103H7521-8051	103H7521-8021	0.46 (65.1)	1.5	0.6	1.1	0.148 (0.81)	0.51 (1.12)
103H7522-7051	103H7522-7021	0.735 (104.1)	0.75	3.3	7.5	0.18 (0.98)	0.6 (1.32)
103H7522-8051	103H7522-8021	0.735 (104.1)	1.5	0.75	2	0.18 (0.98)	0.6 (1.32)
103H7523-7051	103H7523-7021	1.568 (222.0)	0.75	5.2	21	0.423 (2.31)	1.1 (2.43)
103H7523-8051	103H7523-8021	1.568 (222.0)	1.5	1.4	5.4	0.423 (2.31)	1.1 (2.43)

Characteristics

103H7521-7051
103H7521-7021

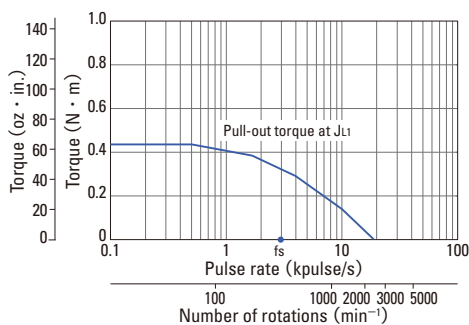

Constant current circuit
Source voltage : DC24V · operating current : 0.75A/phase
5-phase excitation (full step)
JL1= [0.94 × 10⁻⁴kg · m² (5.14 oz · in²) use the rubber coupling]
fs: Maximum self - start frequency when not loaded

103H7521-8051
103H7521-8021

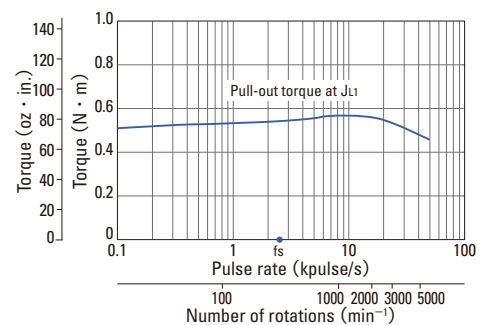

Constant current circuit
Source voltage : AC100V · operating current : 1.5A/phase
5-phase excitation (full step)
JL1= [0.94 × 10⁻⁴kg · m² (5.14 oz · in²) use the rubber coupling]
fs: Maximum self - start frequency when not loaded

103H7522-7051
103H7522-7021

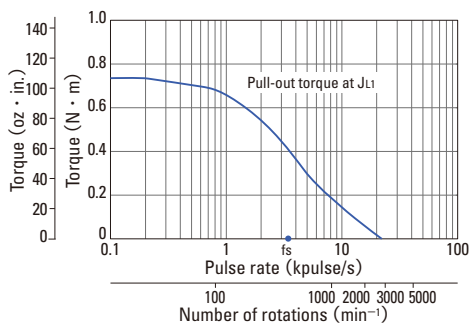

Constant current circuit
Source voltage : DC24V · operating current : 0.75A/phase
5-phase excitation (full step)
JL1= [0.94 × 10⁻⁴kg · m² (14.22 oz · in²) use the rubber coupling]
fs: Maximum self - start frequency when not loaded

103H7522-8051
103H7522-8021

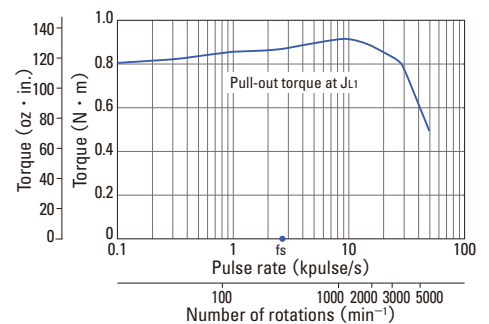

Constant current circuit
Source voltage : AC100V · operating current : 1.5A/phase
5-phase excitation (full step)
JL1= [2.6 × 10⁻⁴kg · m² (14.22 oz · in²) use the rubber coupling]
fs: Maximum self - start frequency when not loaded

103H7523-7051
103H7523-7021

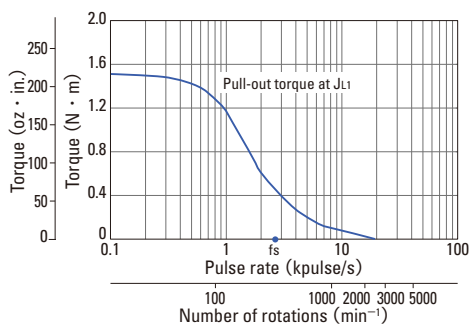

Constant current circuit
Source voltage : DC24V · operating current : 0.75A/phase
5-phase excitation (full step)
JL1= [2.6 × 10⁻⁴kg · m² (40.46 oz · in²) use the rubber coupling]
fs: Maximum self - start frequency when not loaded

103H7523-8051
103H7523-8021

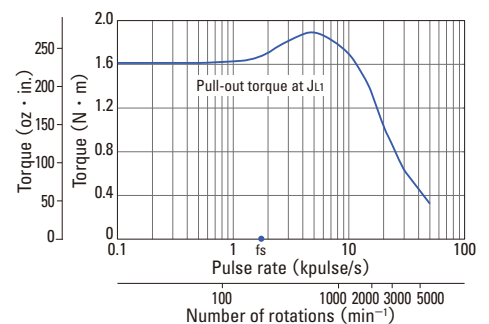

Constant current circuit
Source voltage : AC100V · operating current : 1.5A/phase
5-phase excitation (full step)
JL1= [7.4 × 10⁻⁴kg · m² (40.46 oz · in²) use the rubber coupling]
fs: Maximum self - start frequency when not loaded



φ 86mm (φ 3.39inch)

0.72° /step
Motor with leads

Model number		Holding torque at 5-phase energization	Rated current	Wiring resistance	Winding inductance	Rotor inertia	Mass(Weight)
Single shaft	Double shaft	[N · m (oz · in) MIN.]	A/phase	Ω /phase	mH/phase	[× 10 ⁻⁴ kg · m ² (oz · in ²)]	kg (lbs)
103H8581-7041	103H8581-7011	2.06 (291.7)	0.75	5.7	25	1.45 (7.93)	1.5 (3.31)
103H8581-8041	103H8581-8011	2.06 (291.7)	1.5	1.5	5.6	1.45 (7.93)	1.5 (3.31)
103H8582-7041	103H8582-7011	4.02 (569.3)	0.75	8.6	41	2.9 (15.86)	2.5 (5.51)
103H8582-8041	103H8582-8011	4.02 (569.3)	1.5	2	10.6	2.9 (15.86)	2.5 (5.51)
103H8583-7041	103H8583-7011	6.17 (873.7)	0.75	10.5	59	4.4 (24.06)	3.5 (7.72)
103H8583-8041	103H8583-8011	6.17 (873.7)	1.5	2.5	15	4.4 (24.06)	3.5 (7.72)

Characteristics

103H8581-7041
103H8581-7011

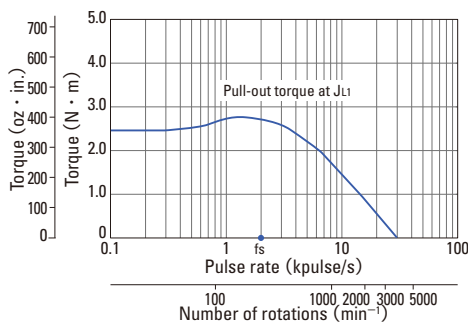

Constant current circuit
Source voltage : AC100V · operating current : 0.75A/phase
5-phase excitation (full step)
JL1= [7.4 × 10⁻⁴kg · m² (40.46 oz · in²) use the rubber coupling]
fs: Maximum self - start frequency when not loaded

103H8581-8041
103H8581-8011

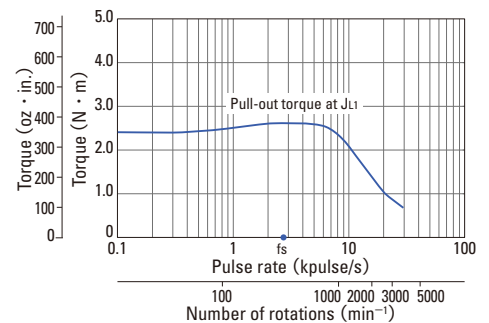

Constant current circuit
Source voltage : AC100V · operating current : 1.5A/phase
5-phase excitation (full step)
JL1= [7.4 × 10⁻⁴kg · m² (40.46 oz · in²) use the rubber coupling]
fs: Maximum self - start frequency when not loaded

103H8582-7041
103H8582-7011

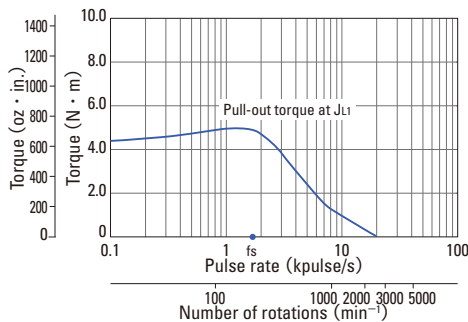

Constant current circuit
Source voltage : AC100V · operating current : 0.75A/phase
5-phase excitation (full step)
JL1= [15.3 × 10⁻⁴kg · m² (83.65 oz · in²) use the rubber coupling]
fs: Maximum self - start frequency when not loaded

103H8582-8041
103H8582-8011

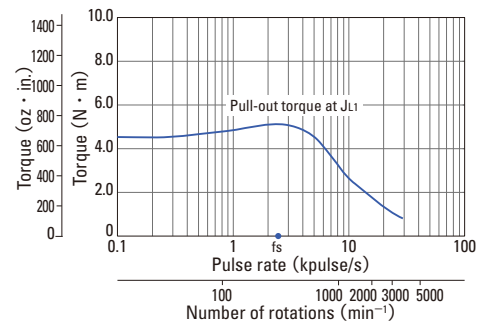

Constant current circuit
Source voltage : AC100V · operating current : 1.5A/phase
5-phase excitation (full step)
JL1= [15.3 × 10⁻⁴kg · m² (83.65 oz · in²) use the rubber coupling]
fs: Maximum self - start frequency when not loaded

103H8583-7041
103H8583-7011

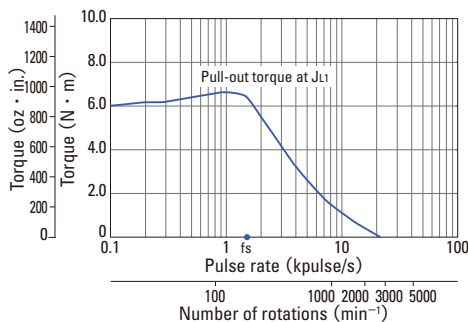

Constant current circuit
Source voltage : AC100V · operating current : 0.75A/phase
5-phase excitation (full step)
JL1= [43 × 10⁻⁴kg · m² (235.10 oz · in²) use the rubber coupling]
fs: Maximum self - start frequency when not loaded

103H8583-8041
103H8583-8011

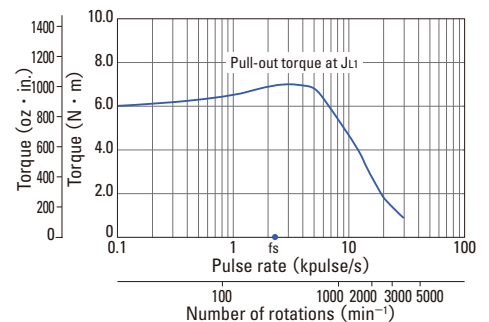

Constant current circuit
Source voltage : AC100V · operating current : 1.5A/phase
5-phase excitation (full step)
JL1= [43 × 10⁻⁴kg · m² (235.10 oz · in²) use the rubber coupling]
fs: Maximum self - start frequency when not loaded



φ 106mm (φ 4.17inch)

0.72° /step

Motor with leads

Model number		Holding torque at 5-phase energization	Rated current	Wiring resistance	Winding inductance	Rotor inertia	Mass(Weight)
Single shaft	Double shaft	[N · m (oz · in) MIN.]	A/phase	Ω /phase	mH/phase	[× 10 ⁻⁴ kg · m ² (oz · in ²)	kg (lbs)
103H89582-7041	103H89582-7011	10.8 (1529.4)	0.75	9	90	14.6 (79.83)	7.5 (16.53)
103H89582-8041	103H89582-8011	10.8 (1529.4)	1.5	2	26	14.6 (79.83)	7.5 (16.53)
103H89583-7041	103H89583-7011	16 (2265.7)	0.75	12.5	125	22 (120.28)	10.5 (23.15)
103H89583-8041	103H89583-8011	16 (2265.7)	1.5	2.9	33.4	22 (120.28)	10.5 (23.15)

Characteristics

103H89582-7041
103H89582-7011

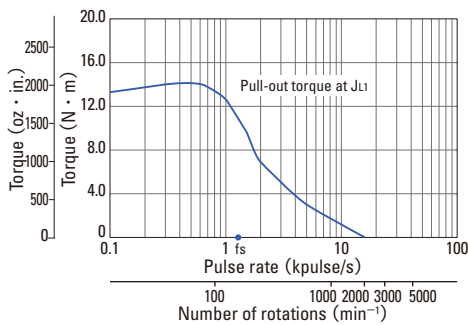

Constant current circuit
Source voltage : AC100V · operating current : 0.75A/phase
5-phase excitation (full step)
JL1= [43 × 10⁻⁴kg · m² (235.10 oz · in²) use the rubber coupling]
fs: Maximum self - start frequency when not loaded

103H89582-8041
103H89582-8011

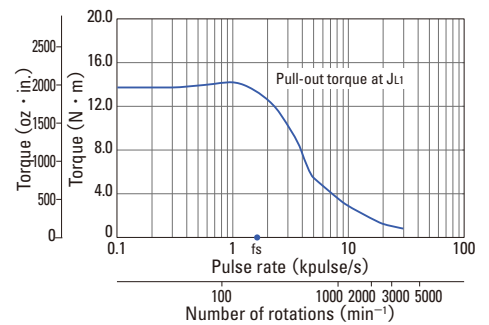

Constant current circuit
Source voltage : AC100V · operating current : 1.5A/phase
5-phase excitation (full step)
JL1= [43 × 10⁻⁴kg · m² (235.10 oz · in²) use the rubber coupling]
fs: Maximum self - start frequency when not loaded

103H89583-7041
103H89583-7011

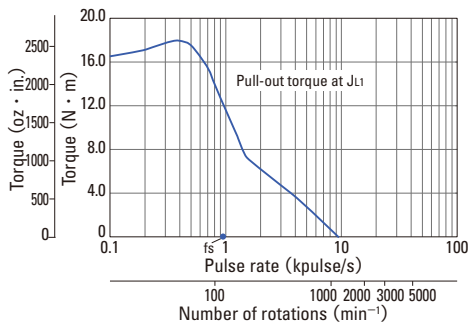

Constant current circuit
Source voltage : AC100V · operating current : 0.75A/phase
5-phase excitation (full step)
JL1= [43 × 10⁻⁴kg · m² (235.10 oz · in²) use the rubber coupling]
fs: Maximum self - start frequency when not loaded

103H89583-8041
103H89583-8011

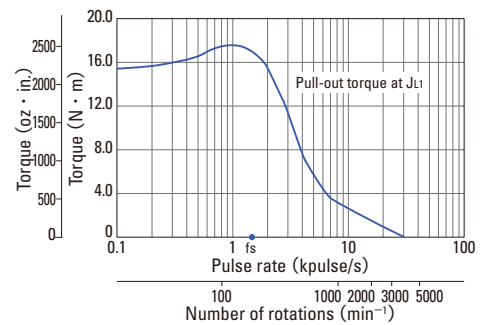

Constant current circuit
Source voltage : AC100V · operating current : 1.5A/phase
5-phase excitation (full step)
JL1= [43 × 10⁻⁴kg · m² (235.10 oz · in²) use the rubber coupling]
fs: Maximum self - start frequency when not loaded

Allowable radial / thrust load

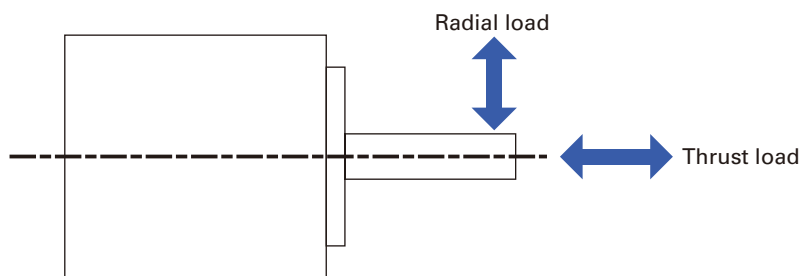

Motor size	Model number	unit	Distance from end of shaft : mm (inch)				Thrust load
			0	5 (0.2)	10 (2.25)	15 (3.38)	
			Radial load				
28mm sq. (1.10 inch sq.)	SH528 □ - □ 0 □ 1	N	42	47	53	—	3
		lbs	9	10	11	—	0.67
39mm sq. (1.54 inch sq.)	103-45 □ □ -70 □ 0	N	26	33	42	60	10
		lbs	5	7	9	13	2.25
42mm sq. (1.65 inch sq.)	103H55 □ □ -70 □ 0 103F55 □ □	N	29	36	49	52	10
		lbs	6	8	11	11	2.25
50mm sq. (1.97 inch sq.)	103H650 □ - □ 0 □ 1	N	71	87	115	167	15
		lbs	15	19	25	37	3.37
60mm sq. (2.36inch sq.)	103H785 □ - □ 0 □ 1	N	70	87	114	165	20
		lbs	15	19	25	37	4.5
	103F78 □ □ 103M78 □ □	N	62	75	94	127	20
		lbs	13	16	21	28	4.5
φ 60mm (φ 2.36 inch)	103-7566-70 □ 1	N	68	85	113	166	15
		lbs	15	19	25	37	3.37
	103H752 □ - □ 0 □ 1	N	94	116	153	222	15
		lbs	21	26	34	49	3.37
φ 86mm (φ 3.39 inch)	103H858 □ -6 □ □ 0	N	191	234	301	421	60
		lbs	42	52	67	94	13
	103F85 □ □ 103M85 □ □	N	350	424	535	726	60
		lbs	78	95	120	163	13
φ 106mm (φ 4.17 inch)	103H8958 □ -6 □ □ 0 103F895 □ □ 103M895 □ □	N	321	356	401	457	100
		lbs	72	80	90	102	22

Internal wire connection and direction of motor rotate

Internal wire connection

Connector pin numbers in parentheses ().

Connection Method: Pentagon

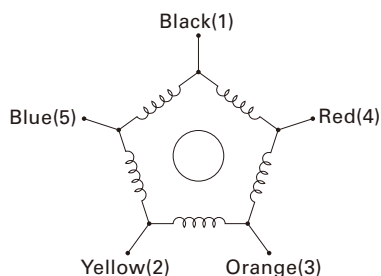

Direction of motor rotate

The direction of motor rotate is counterclockwise when viewed from the output shaft side at the direct current energization in the following order.

As for some of the models with the gear, the direction of motor rotation is different, please make inquiries.

Type		Exciting order										
		1	2	3	4	5	6	7	8	9	10	
Color of leads	Black	(1)	-	-	-	-		+	+	+	+	
	Red	(4)		+	+	+	+		-	-	-	
	Orange	(3)	+		-	-	-	-		+	+	+
	Yellow	(2)	-	-		+	+	+	+		-	-
	Blue	(5)	+	+	+		-	-	-	-		+

AC input Set model
Micro step

DC input Set model
Micro step

DC input Set model
Full / half step

Stepping Motor

Linear Actuator
Stepping Motor

Stepping motor for
vacuum environment

Dimensions

General specifications

Model number	SH528 □	103H55 □□	103H650 □	103H752 □	103H785 □	103H858 □	103H8958 □	103-45 □□	103-7566
Ambient operation temperature	- 10 to + 50°C								
Storage temperature	- 20 to + 65°C								
Ambient operation humidity	20 to 90% RH (no condensation)								
Storage humidity	5 to 95% RH (no condensation)								
Operation altitude	1000 m (3280 feet) MAX. above sea level								
Vibration resistance	Vibration frequency 10 to 500 Hz, total amplitude 1.52 mm (10 to 70 Hz), vibration acceleration 147 m/s ² (70 to 500 Hz), sweep time 15 min/cycle, 12 sweeps in each X, Y and Z direction.								
Impact resistance	490m/s ² of acceleration for 11 ms with half-sine wave applying three times for X, Y, and Z axes each, 18 times in total.								
Insulation class	Class B (+ 130°C)								
Withstand voltage	At normal ambient temperature and humidity, no failure with 1000 V AC @50/60 Hz applied for one minute between motor winding and frame (500 V AC for models SH528 □, 103H55 □□, and 103-45 □□).								
Insulation resistance	At normal ambient temperature and humidity, 100 Mohm or more on megger with 500 V DC between motor winding and frame.								
Protection grade	IP40								
Wiring temperature increase	80K MAX. (Based on Sanyo Denki standard)								
Standing angle error	± 0.09°	± 0.09°	± 0.09°	± 0.09°	± 0.09°	± 0.09°	± 0.09°	± 0.04°	± 0.09°
Axial play ^(Note1)	0.075mm (0.002952inch) MAX., Load 4.4N (1lbs)	0.075mm (0.002952inch) MAX., Load 4.4N (1lbs)	0.075mm (0.002952inch) MAX., Load 9N (2lbs)	0.075mm (0.002952inch) MAX., Load 9N (2lbs)	0.075mm (0.002952inch) MAX., Load 9N (2lbs)	0.075mm (0.002952inch) MAX., Load 9N (2lbs)	0.075mm (0.002952inch) MAX., Load 9N (2lbs)	0.075mm (0.002952inch) MAX., Load 4.4N (1lbs)	0.075mm (0.002952inch) MAX., Load 9N (2lbs)
Radial play ^(Note2)	0.025mm (0.00098inch) MAX., Load 4.4N (1lbs)						0.05mm (0.00196inch)	0.025mm (0.00098inch)	
Shaft runout	0.025mm (0.00098inch)						0.05mm (0.00196inch)	0.025mm (0.00098inch)	
Inserted part concentricity against shaft	φ 0.05mm (φ 0.00197inch)	φ 0.05mm (φ 0.00197inch)	φ 0.075mm (φ 0.00295inch)	φ 0.075mm (φ 0.00295inch)	φ 0.075mm (φ 0.00295inch)	φ 0.075mm (φ 0.00295inch)	φ 0.075mm (φ 0.00295inch)	φ 0.05mm (φ 0.00197inch)	φ 0.075mm (φ 0.00295inch)
Fitted surface angularity against shaft	0.1mm (0.00394inch)	0.1mm (0.00394inch)	0.075mm (0.00295inch)	0.075mm (0.00295inch)	0.075mm (0.00295inch)	0.075mm (0.00295inch)	0.075mm (0.00295inch)	0.075mm (0.00295inch)	0.075mm (0.00295inch)

(Note1) Axial play: Shaft displacement under axial load.

(Note2) Radial play: Shaft displacement under radial load applied 1/3rd of the length from the end of the shaft.

Linear Actuator Stepping Motor

Dimensions ▶ P.106



Features

- System Miniaturization
This product incorporates a ball screw inside the stepping motor to make it compact. This allows equipment size to be reduced.
- Large Thrust
- Long Stroke Length

Application

Semiconductor manufacturing equipment, general industrial machinery, machine tools application and transport equipment.

Specifications

Set Model number	SL5421-7241	SL5421-72XB41	SL5601-8241	SL5601-82XB41
Brake	Without	With	Without	With
Motor size	42mm (1.65inch)		60mm (2.36inch)	
Rated current	0.75A/phase		1.4A/phase	
Stroke	50mm (1.97inch)		80mm (3.14inch)	
Thrust	370N		450N	
Brake retention	Without	370N	Without	450N
Speed	48mm/s		64mm/s	
Resolution	0.004mm (0.0001inch)		0.008mm (0.0002inch)	
Positioning repeatability	± 0.02mm			
Lost motion	0.1mm (0.00394inch)			
Mass	0.65kg	0.8kg	1.4kg	1.7kg
Standard combined stepping driver model	FS1D140P10 (Specifications ▶ P.79)			

• Connection Method: New Pentagon

Characteristics

Set model number : SL5421-72

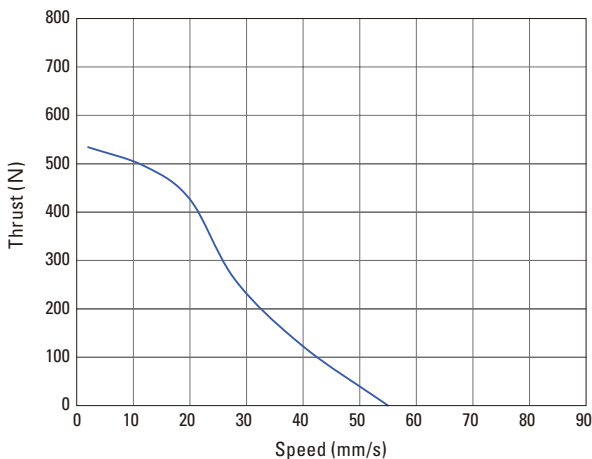

Drive condition
 Driver : FS1D140P10
 Source current : 24 VDC
 Excitation current : 0.75 A/phase
 Excitation mode : 4-phase excitation (Full step)

Set model number : SL5601-82

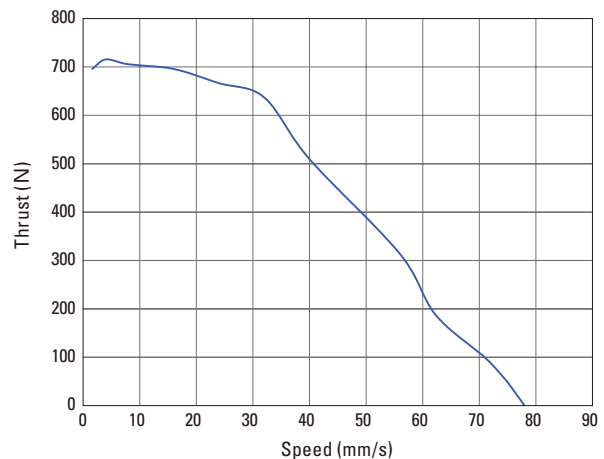

Drive condition
 Driver : FS1D140P10
 Source current : 24 VDC
 Excitation current : 1.4 A/phase
 Excitation mode : 4-phase excitation (Full step)

AC input Set model
Micro step

DC input Set model
Micro step

DC input Set model
Full / half step

Stepping Motor

Linear Actuator
Stepping Motor

Stepping motor for
vacuum environment

Dimensions

Stepping motor for vacuum environment

Customized Products



Features

- This stepping motor can operate within a vacuum environment without requiring an introducer. It can be used as an actuator in a vacuum environment while maintaining its stepping capabilities for precise control with a simple open loop.
- Customizable stepping motor for a wide range of pressure environments from low to ultra-high vacuums.
- Available baked at 200° C.
- Size is almost the same as normal stepping motors.

Intended Operating Pressure

low vacuum			medium vacuum			high vacuum			ultra-high vacuum				
10^5	10^4	10^3	10^2	10^1	1	10^{-1}	10^{-2}	10^{-3}	10^{-4}	10^{-5}	10^{-6}	10^{-7}	10^{-8} [Pa]

Application

Ideal for the following applications. Contact us to discuss your particular application environment needs.

- Semiconductor manufacturing equipment
- Satellite robotics
- Electron microscopes
- Major research facilities such as particle accelerators and radiation analysis systems.

Motor size

39mm sq.(1.54inch sq.) to ϕ 106mm(ϕ 4.17inch)

Stepping motor dimensions [Unit : mm (inch)]

■ Set model configuration motor (standard model / CE · UL model) · Stepping Motor

28mm sq. (1.10inch sq.)

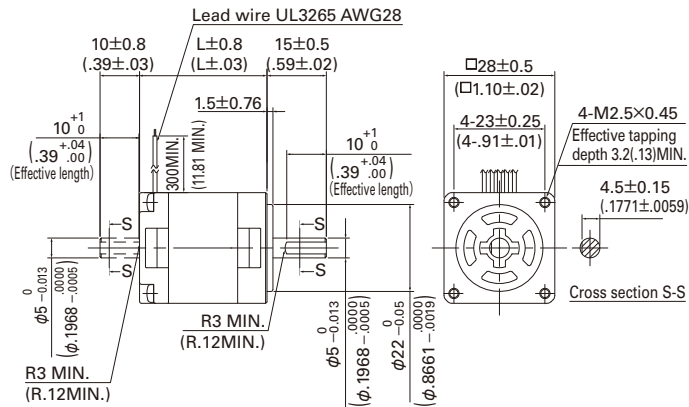

Set model number		Motor model number		Motor length (L) [mm(inch)]
Single shaft	Double shaft	Single shaft	Double shaft	
FAF521S	FAF521D	SH5281-7241	SH5281-7211	32 (1.26)
FD521S	FD521D			
FAF525S	FAF525D	SH5285-7241	SH5285-7211	51.5 (2.03)
FD525S	FD525D			
-	-	SH5281-3041	SH5281-3011	32 (1.26)
-	-	SH5281-7041	SH5281-7011	
-	-	SH5285-3041	SH5285-3011	51.5 (2.03)
-	-	SH5285-7041	SH5285-7011	

39mm sq. (1.54inch sq.)

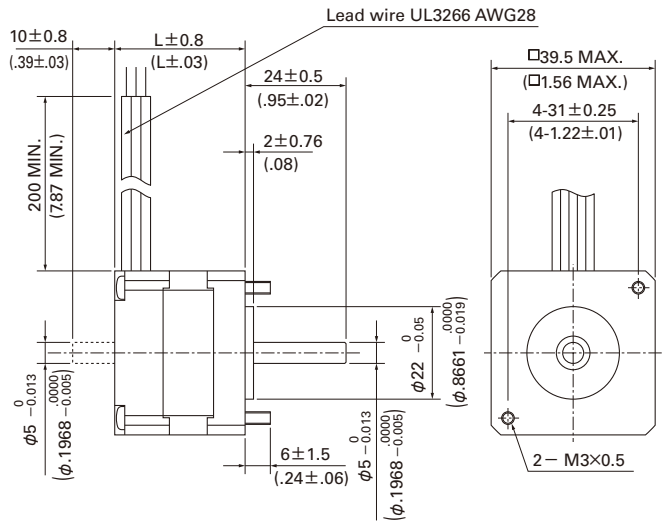

Set model number	Motor model number		Motor length (L) [mm(inch)]
	Single shaft	Double shaft	
-	103-4505-7040	103-4505-7010	31 (1.22)
-	103-4507-7040	103-4507-7010	35.2 (1.39)
-	103-4510-7040	103-4510-7010	44.3 (1.74)

42mm sq. (1.65inch sq.)

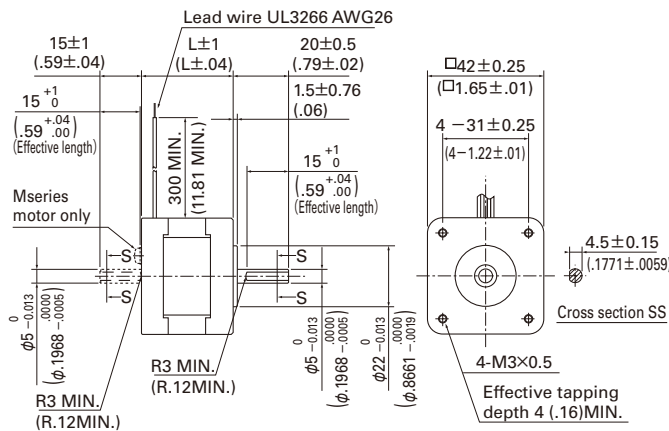

Set model number		Motor model number		Motor length (L) [mm(inch)]
Single shaft	Double shaft	Single shaft	Double shaft	
FSF551S	FSF551D	103F5505-7041	103F5505-7011	34 (1.34)
F551S	F551D			
F552S	F552D	103F5508-7041	103F5508-7011	40 (1.57)
F552S	F552D			
F554S	F554D	103F5510-7041	103F5510-7011	49 (1.93)
F554S	F554D			
FAF551S	FAF551D	103F5505-8241	103F5505-8211	34 (1.34)
FD551S	FD551D			
FAF552S	FAF552D	103F5508-8241	103F5508-8211	40 (1.57)
FD552S	FD552D			
FAF554S	FAF554D	103F5510-8241	103F5510-8211	49 (1.93)
FD554S	FD554D			

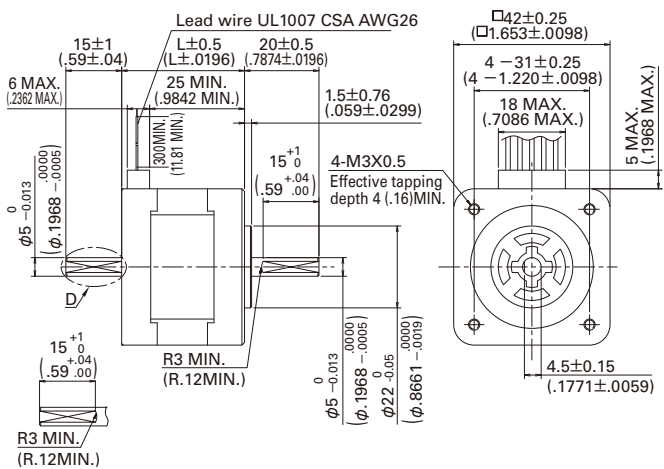

Set model number	Motor model number		Motor length (L) [mm(inch)]
	Single shaft	Double shaft	
-	103H5505-7040	103H5505-7010	33 (1.3)
-	103H5508-7040	103H5508-7010	39 (1.54)
-	103H5510-7040	103H5510-7010	48 (1.89)

AC input Set model
Micro step

DC input Set model
Micro step

DC input Set model
Full / half step

Stepping Motor

Linear Actuator
Stepping Motor

Stepping motor for
vacuum environment

Dimensions

Stepping motor dimensions [Unit : mm (inch)]

■ Set model configuration motor (standard model / CE · UL model) · Stepping Motor

50mm sq. (1.97inch sq.)

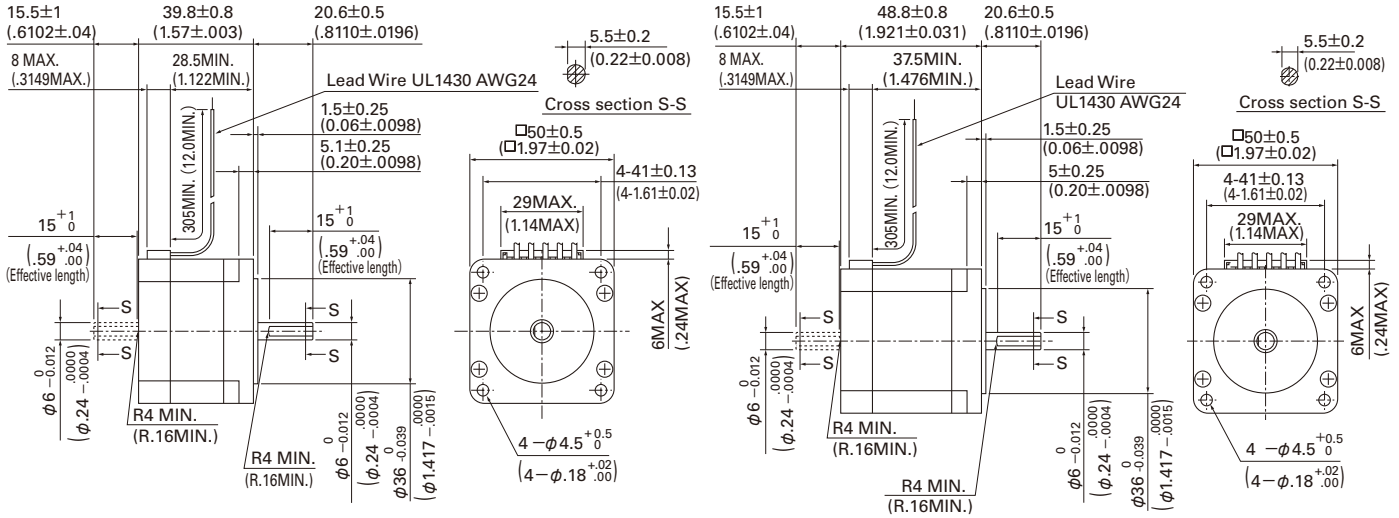

Set model number	Motor model number	
	Single shaft	Double shaft
-	103H6500-7041	103H6500-7011
-	103H6500-8041	103H6500-8011

Set model number	Motor model number	
	Single shaft	Double shaft
-	103H6501-7041	103H6501-7011
-	103H6501-8041	103H6501-8011

60mm sq. (2.36inch sq.)

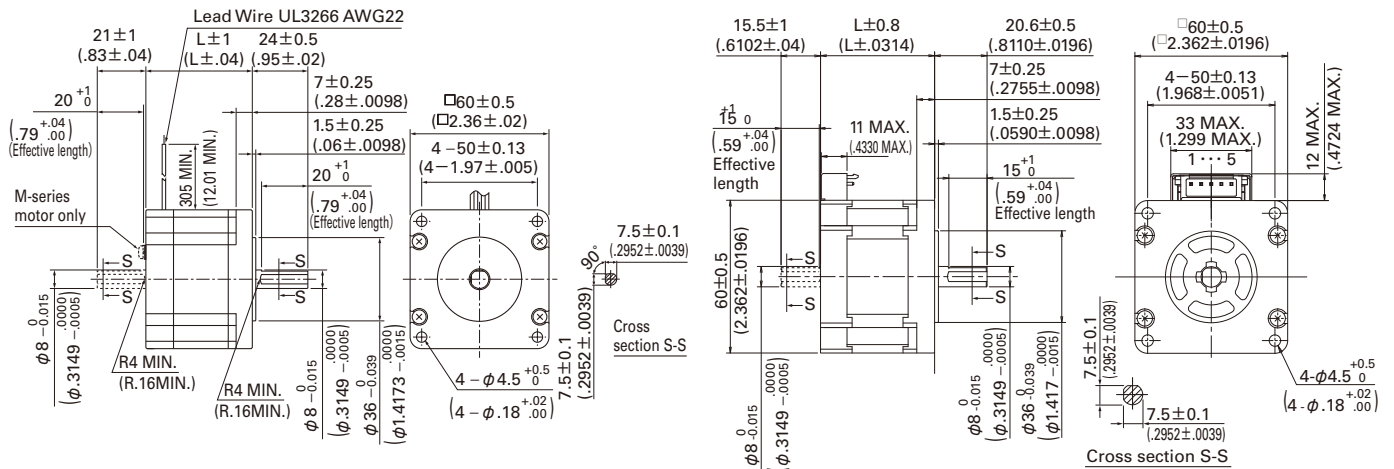

Set model number	Motor model number		Motor length (L) [mm(inch)]	
	Single shaft	Double shaft		
FSF781S	FSF781D	103F7851-7041	103F7851-7011	46.5 (1.83)
FSM781S	FSM781D	103M7851-7041	103M7851-7011	
FSF782S	FSF782D	103F7852-7041	103F7852-7011	55 (2.17)
FSM782S	FSM782D	103M7852-7041	103M7852-7011	
FSF783S	FSF783D	103F7853-7041	103F7853-7011	87.5 (3.44)
FSM783S	FSM783D	103M7853-7041	103M7853-7011	
FAF781S	FAF781D	103F7851-8241	103F7851-8211	46.5 (1.83)
FAF782S	FAF782D	103F7852-8241	103F7852-8211	
FAF783S	FAF783D	103F7853-8241	103F7853-8211	87.5 (3.44)
FD781S	FD781D	103F7851-8241	103F7851-8211	
FD782S	FD782D	103F7852-8241	103F7852-8211	55 (2.17)
FD783S	FD783D	103F7853-8241	103F7853-8211	

Set model number	Motor model number		Motor length (L) [mm(inch)]
	Single shaft	Double shaft	
-	103H7851-7051	103H7851-7021	44.8 (1.76)
-	103H7851-8051	103H7851-8021	
-	103H7852-7051	103H7852-7021	53.8 (2.1)
-	103H7852-8051	103H7852-8021	
-	103H7853-7051	103H7853-7021	85.8 (3.38)
-	103H7853-8051	103H7853-8021	

Motor cable Model No. : 4837847-1

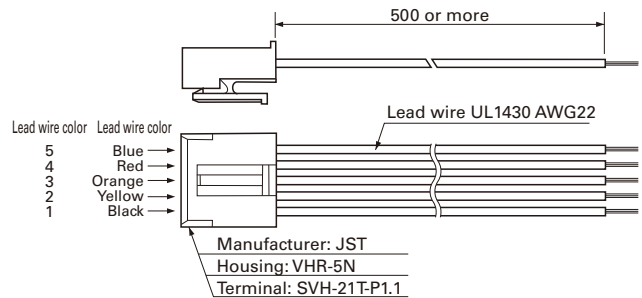

Cable for model number : 103H785□-□□□1 motor (between motor and driver)

Set model configuration motor (standard model / CE · UL model) · Stepping Motor

φ 60mm (φ 2.36inch)

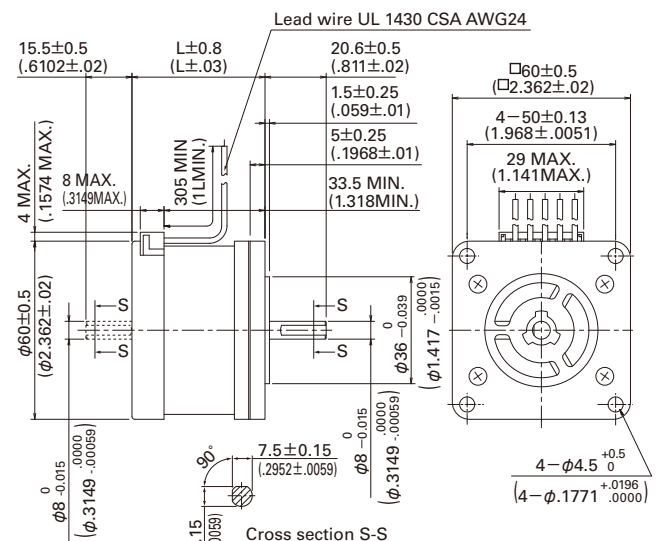
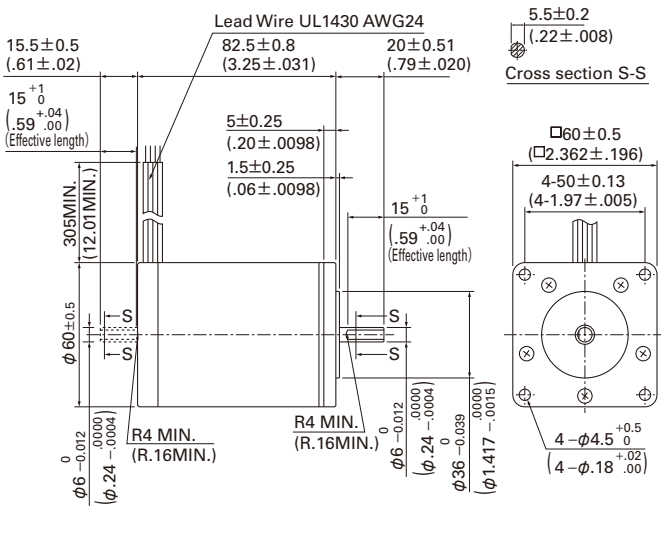

Set model number	Motor model number	
	Single shaft	Double shaft
-	103-7566-7041	103-7566-7011

Set model number	Motor model number		Motor length (L) [mm(inch)]
	Single shaft	Double shaft	
-	103H7521-7051 103H7521-8051	103H7521-7021 103H7521-8021	44.8 (1.76)
-	103H7522-7051 103H7522-8051	103H7522-7021 103H7522-8021	53.8 (2.1)
-	103H7523-7051 103H7523-8051	103H7523-7021 103H7523-8021	85.8 (3.38)

φ 86mm (φ 3.39inch)

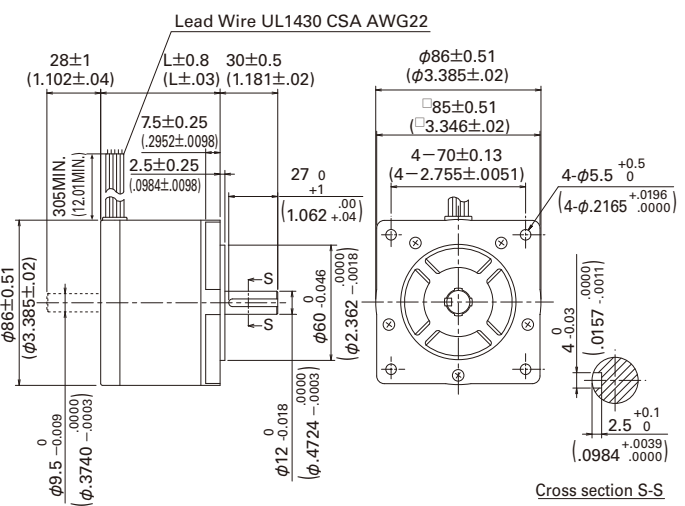
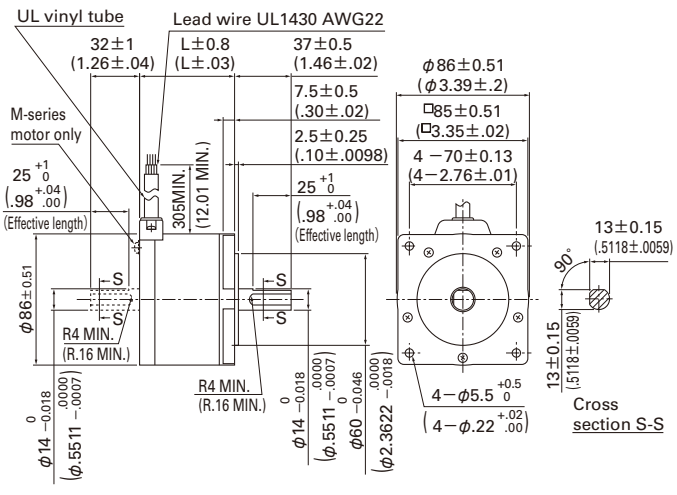

Set model number	Motor model number		Motor length (L) [mm(inch)]	
	Single shaft	Double shaft		
FSF851S	FSF851D	103F8581-7041	103F8581-7011	62.15 (2.47)
FSM851S	FSM851D	103M8581-7041	103M8581-7011	62.15 (2.47)
FSF852S	FSF852D	103F8582-7041	103F8582-7011	92.2 (3.63)
FSM852S	FSM852D	103M8582-7041	103M8582-7011	92.2 (3.63)
FSF853S	FSF853D	103F8583-7041	103F8583-7011	125.85 (4.95)
FSM853S	FSM853D	103M8583-7041	103M8583-7011	125.85 (4.95)
FAF851S	FAF851D	103F8581-8241	103F8581-8211	62.15 (2.47)
FD851S	FD851D	103F8581-8241	103F8581-8211	62.15 (2.47)
FAF852S	FAF852D	103F8582-8241	103F8582-8211	92.2 (3.63)
FD852S	FD852D	103F8582-8241	103F8582-8211	92.2 (3.63)

Set model number	Motor model number		Motor length (L) [mm(inch)]
	Single shaft	Double shaft	
-	103H8581-7041 103H8581-8041	103H8581-7011 103H8581-8011	62.15 (2.47)
-	103H8582-7041 103H8582-8041	103H8582-7011 103H8582-8011	92.2 (3.63)
-	103H8583-7041 103H8583-8041	103H8583-7011 103H8583-8011	125.85 (4.95)

Stepping motor dimensions [Unit : mm (inch)]

■ Set model configuration motor (Standard model / CE · UL model) · Stepping motor

φ 106mm (φ 4.17inch)

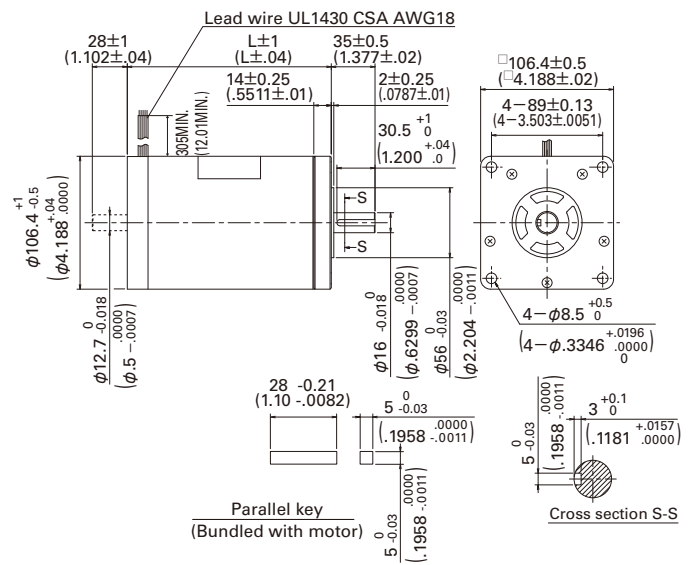
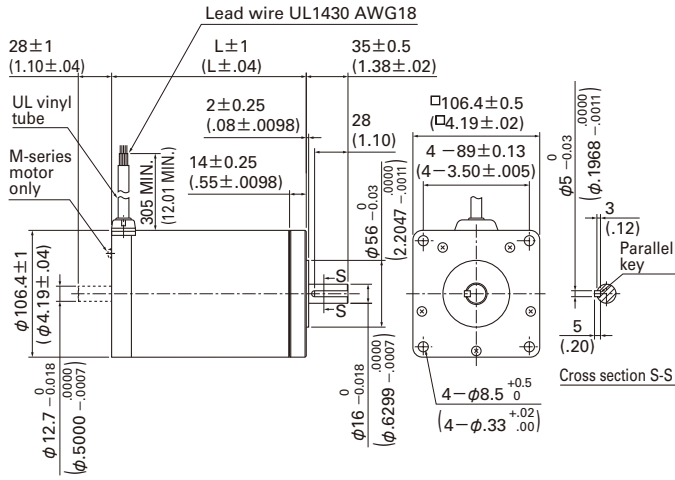

Set model number		Motor model number		Motor length (L) [mm(inch)]
Single shaft	Double shaft	Single shaft	Double shaft	
FSF892S	FSF892D	103F89582-7041	103F89582-7011	163.3 (6.43)
FSM892S	FSM892D	103M89582-7041	103M89582-7011	
FSF893S	FSF893D	103F89583-7041	103F89583-7011	221.3 (8.71)
FSM893S	FSM893D	103M89583-7041	103M89583-7011	

Set model number	Motor model number		Motor length (L) [mm(inch)]
	Single shaft	Double shaft	
-	103H89582-7041	103H89582-7011	163.3 (6.43)
	103H89582-8041	103H89582-8011	
-	103H89583-7041	103H89583-7011	221.3 (8.71)
	103H89583-8041	103H89583-8011	

Set model configuration motor (Low-backlash gear model)

42mm sq. (1.65inch sq.)

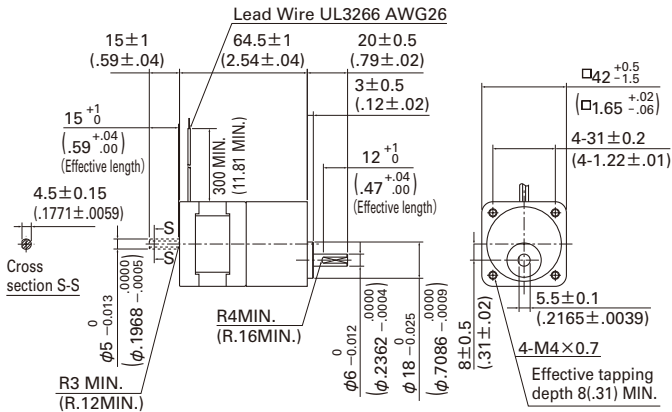

60mm sq. (2.36inch sq.)

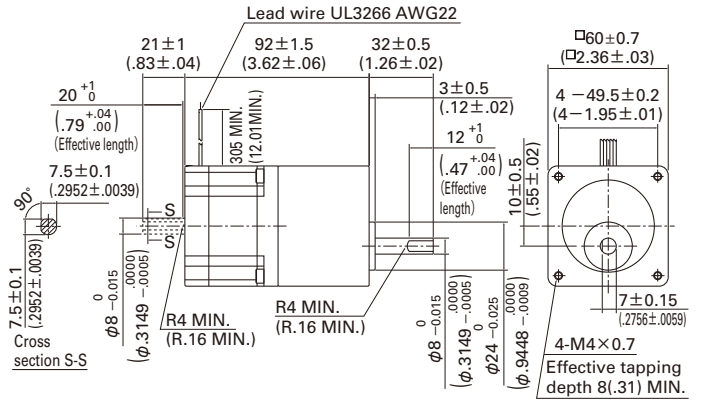

Set model number		Motor model number	
Single shaft	Double shaft	Single shaft	Double shaft
F □ F551S-CX3.6	F □ F551D-CX3.6	103F5505- ■■ CXA4	103F5505- ■■ CXA1
F □ F551S-CX7.2	F □ F551D-CX7.2	103F5505- ■■ CXB4	103F5505- ■■ CXB1
F □ F551S-CX10	F □ F551D-CX10	103F5505- ■■ CXE4	103F5505- ■■ CXE1
F □ F551S-CX20	F □ F551D-CX20	103F5505- ■■ CXG4	103F5505- ■■ CXG1
F □ F551S-CX30	F □ F551D-CX30	103F5505- ■■ CXJ4	103F5505- ■■ CXJ1
F □ F551S-CX36	F □ F551D-CX36	103F5505- ■■ CXK4	103F5505- ■■ CXK1

Set model number		Motor model number	
Single shaft	Double shaft	Single shaft	Double shaft
F □ F781S-CX3.6	F □ F781D-CX3.6	103F7851- ■■ CXA4	103F7851- ■■ CXA1
F □ F781S-CX7.2	F □ F781D-CX7.2	103F7851- ■■ CXB4	103F7851- ■■ CXB1
F □ F781S-CX10	F □ F781D-CX10	103F7851- ■■ CXE4	103F7851- ■■ CXE1
F □ F781S-CX20	F □ F781D-CX20	103F7851- ■■ CXG4	103F7851- ■■ CXG1
F □ F781S-CX30	F □ F781D-CX30	103F7851- ■■ CXJ4	103F7851- ■■ CXJ1
F □ F781S-CX36	F □ F781D-CX36	103F7851- ■■ CXK4	103F7851- ■■ CXK1

For '□' in the set model numbers, 'S' denotes AC input, 'A' denotes DC input micro-step, and 'D' denotes DC input Full/Half-step.
For '■■' in the motor model numbers, '70' denotes AC input, and '82' denotes DC input.

For '□' in the set model numbers, 'S' denotes AC input, 'A' denotes DC input micro-step, and 'D' denotes DC input Full/Half-step.
For '■■' in the motor model numbers, '70' denotes AC input, and '82' denotes DC input.

φ 86mm (φ 3.39inch)

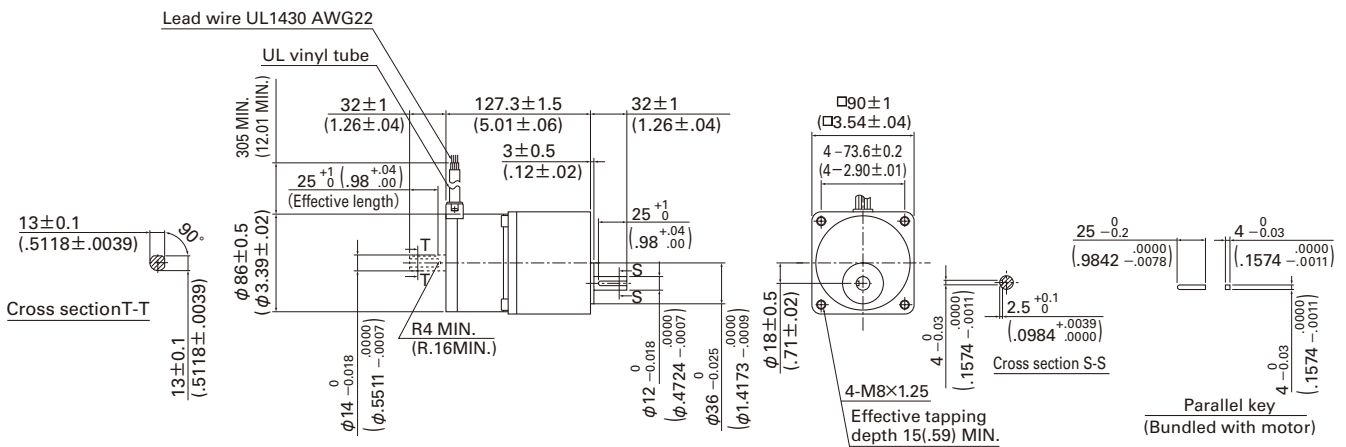

Set model number		Motor model number	
Single shaft	Double shaft	Single shaft	Double shaft
F □ F851S-CX3.6	F □ F851D-CX3.6	103F8581- ■■ CXA4	103F8581- ■■ CXA1
F □ F851S-CX7.2	F □ F851D-CX7.2	103F8581- ■■ CXB4	103F8581- ■■ CXB1
F □ F851S-CX10	F □ F851D-CX10	103F8581- ■■ CXE4	103F8581- ■■ CXE1
F □ F851S-CX20	F □ F851D-CX20	103F8581- ■■ CXG4	103F8581- ■■ CXG1
F □ F851S-CX30	F □ F851D-CX30	103F8581- ■■ CXJ4	103F8581- ■■ CXJ1
F □ F851S-CX36	F □ F851D-CX36	103F8581- ■■ CXK4	103F8581- ■■ CXK1

For '□' in the set model numbers, 'S' denotes AC input, 'A' denotes DC input micro-step, and 'D' denotes DC input Full/Half-step.
For '■■' in the motor model numbers, '70' denotes AC input, and '82' denotes DC input.

Stepping motor dimensions [Unit : mm (inch)]

Set model configuration motor (Spur gear model)

28mm sq. (1.10inch sq.)

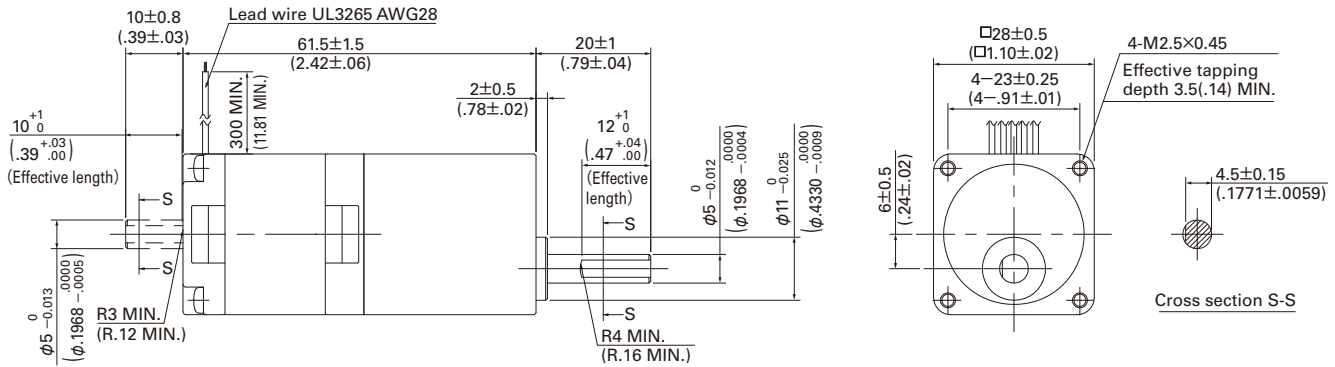

Set model number		Motor model number	
Single shaft	Double shaft	Single shaft	Double shaft
FAF521S-GX3.6	FAF521D-GX3.6	SH5281-72GXA4	SH5281-72GXA1
FD521S-GX3.6	FD521D-GX3.6		
FAF521S-GX7.2	FAF521D-GX7.2	SH5281-72GXB4	SH5281-72GXB1
FD521S-GX7.2	FD521D-GX7.2		
FAF521S-GX10	FAF521D-GX10	SH5281-72GXE4	SH5281-72GXE1
FD521S-GX10	FD521D-GX10		
FAF521S-GX20	FAF521D-GX20	SH5281-72GXG4	SH5281-72GXG1
FD521S-GX20	FD521D-GX20		
FAF521S-GX30	FAF521D-GX30	SH5281-72GXJ4	SH5281-72GXJ1
FD521S-GX30	FD521D-GX30		
FAF521S-GX50	FAF521D-GX50	SH5281-72GXL4	SH5281-72GXL1
FD521S-GX50	FD521D-GX50		

Set model configuration motor (Harmonic gear model)

28mm sq. (1.10inch sq.)

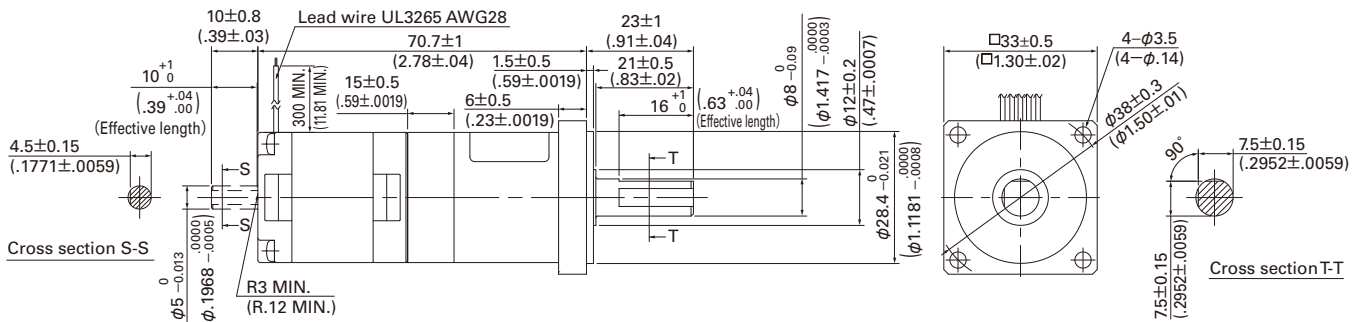

Set model number		Motor model number	
Single shaft	Double shaft	Single shaft	Double shaft
FAF521S-HX50	FAF521D-HX50	SH5281-72HXL4	SH5281-72HXL1
FD521S-HX50	FD521D-HX50		
FAF521S-HX100	FAF521D-HX100	SH5281-72HXM4	SH5281-72HXM1
FD521S-HX100	FD521D-HX100		

42mm sq. (1.65inch sq.)

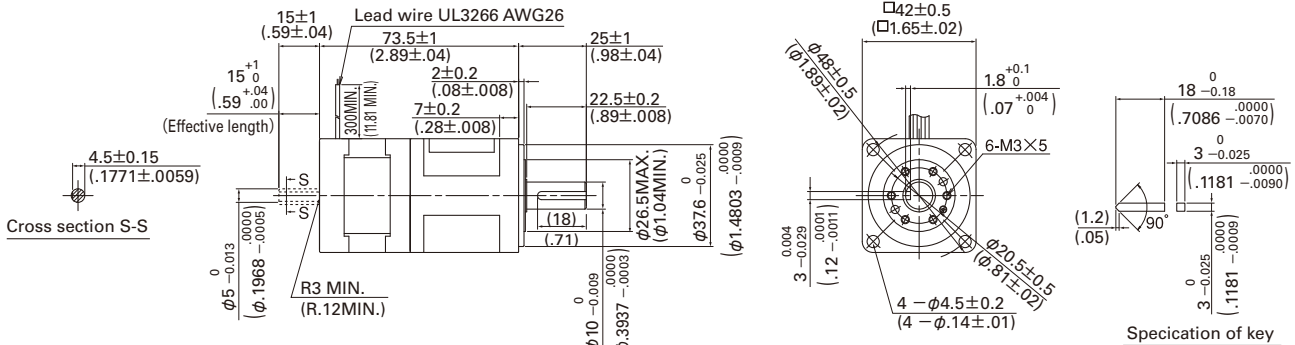

Set model number		Motor model number	
Single shaft	Double shaft	Single shaft	Double shaft
FSF551S-HX30	FSF551D-HX30	103F5505-70HXJ5	103F5505-70HXJ2
FAF551S-HX30	FAF551D-HX30	103F5505-82HXJ5	103F5505-82HXJ2
FD551S-HX30	FD551D-HX30		
FSF551S-HX50	FSF551D-HX50	103F5505-70HXL5	103F5505-70HXL2
FAF551S-HX50	FAF551D-HX50	103F5505-82HXL5	103F5505-82HXL2
FD551S-HX50	FD551D-HX50		
FSF551S-HX100	FSF551D-HX100	103F5505-70HXM5	103F5505-70HXM2
FAF551S-HX100	FAF551D-HX100	103F5505-82HXM5	103F5505-82HXM2
FD551S-HX100	FD551D-HX100		

Set model configuration motor (Harmonic gear model)

60mm sq. (2.36inch sq.)

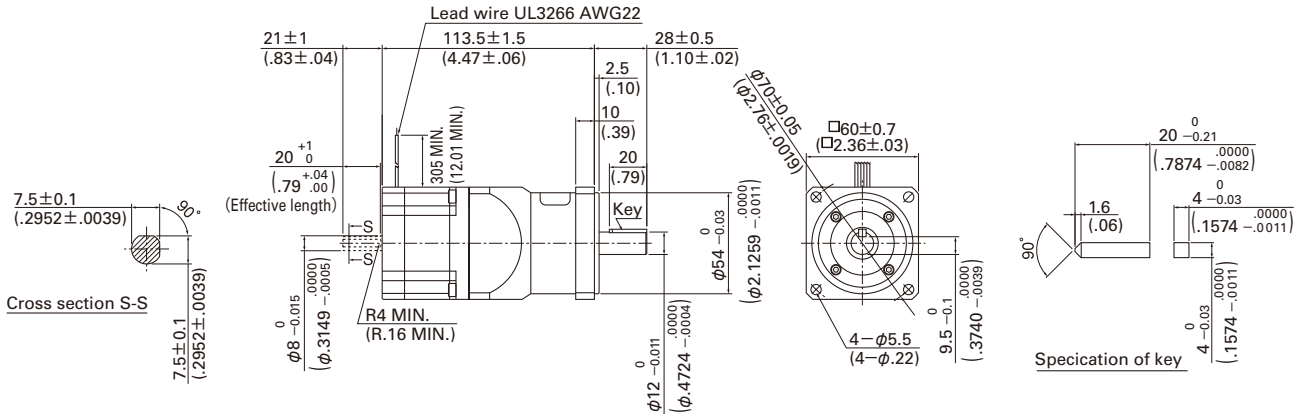

Set model number		Motor model number	
Single shaft	Double shaft	Single shaft	Double shaft
FSF781S-HX50	FSF781D-HX50	103F7851-70HXL4	103F7851-70HXL1
FAF781S-HX50	FAF781D-HX50	103F7851-82HXL4	103F7851-82HXL1
FD781S-HX50	FD781D-HX50		
FSF781S-HX100	FSF781D-HX100	103F7851-70HXM4	103F7851-70HXM1
FAF781S-HX100	FAF781D-HX100	103F7851-82HXM4	103F7851-82HXM1
FD781S-HX100	FD781D-HX100		

φ 86mm (φ 3.39inch)

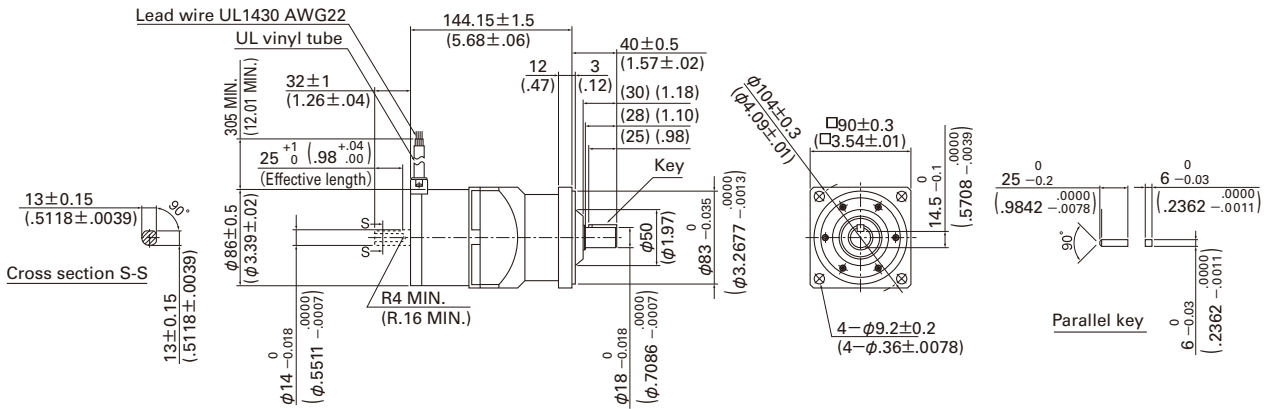

Set model number		Motor model number	
Single shaft	Double shaft	Single shaft	Double shaft
FSF851S-HX50	FSF851D-HX50	103F8581-70HXL4	103F8581-70HXL1
FAF851S-HX50	FAF851D-HX50	103F8581-82HXL4	103F8581-82HXL1
FD851S-HX50	FD851D-HX50		
FSF851S-HX100	FSF851D-HX100	103F8581-70HXM4	103F8581-70HXM1
FAF851S-HX100	FAF851D-HX100	103F8581-82HXM4	103F8581-82HXM1
FD851S-HX100	FD851D-HX100		

Stepping motor dimensions [Unit : mm (inch)]

Set model configuration motor (Electromagnetic brake model)

42mm sq. (1.65inch sq.)

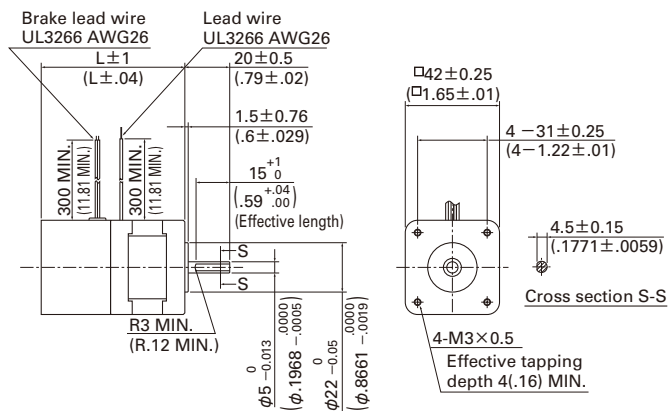

60mm sq. (2.36inch sq.)

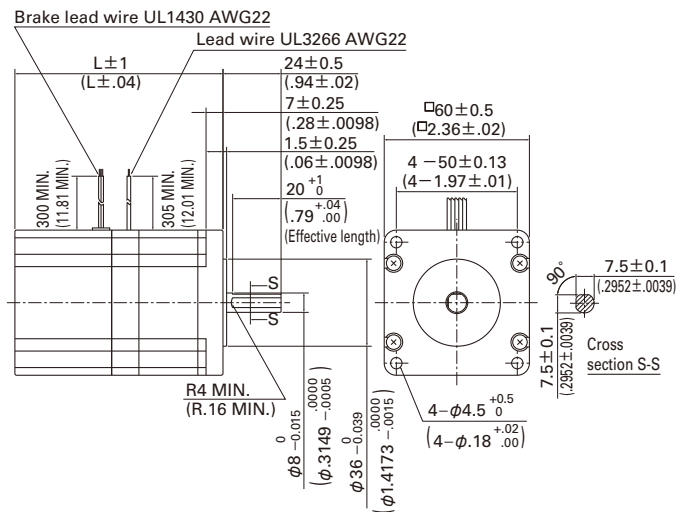

Set model number	Motor model number	Motor + brake length (L)
FSF551S-XB	103F5505-70XB41	64.5 (2.54)
FAF551S-XB	103F5505-82XB41	
FDF551S-XB	103F5508-70XB41	70.5 (2.78)
FSF552S-XB	103F5508-82XB41	
FAF552S-XB	103F5510-70XB41	79.5 (3.13)
FDF552S-XB	103F5510-82XB41	

Set model number	Motor model number	Motor + brake length (L)
FSF781S-XB	103F7851-70XB41	85.8 (3.38)
FAF781S-XB	103F7851-82XB41	
FDF781S-XB	103F7852-70XB41	94.5 (3.72)
FSF782S-XB	103F7852-82XB41	
FAF782S-XB	103F7853-70XB41	126.7 (4.99)
FDF782S-XB	103F7853-82XB41	

φ 86mm (3.39inch)

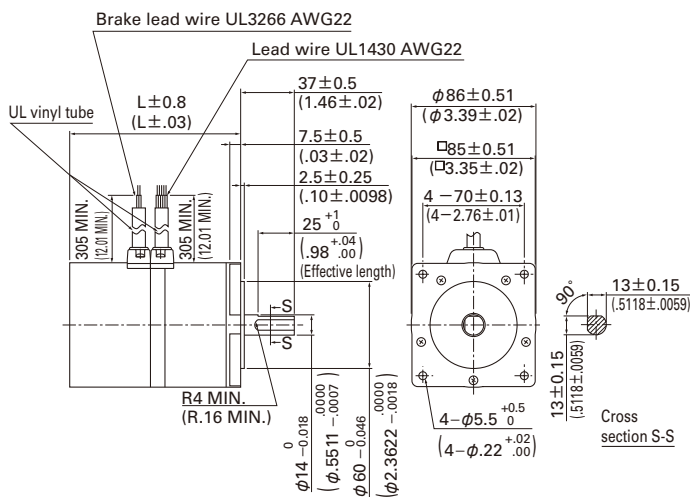

Set model number	Motor model number	Motor + brake length (L)
FSF851S-XB	103F8581-70XB41	116.7 (4.59)
FAF851S-XB	103F8581-82XB41	
FDF851S-XB	103F8582-70XB41	146.8 (5.78)
FSF852S-XB	103F8582-82XB41	
FAF852S-XB	103F8583-70XB41	180.4 (7.10)

Stepping motor dimensions [Unit : mm (inch)]

■ Set model configuration driver (AC input microstep)

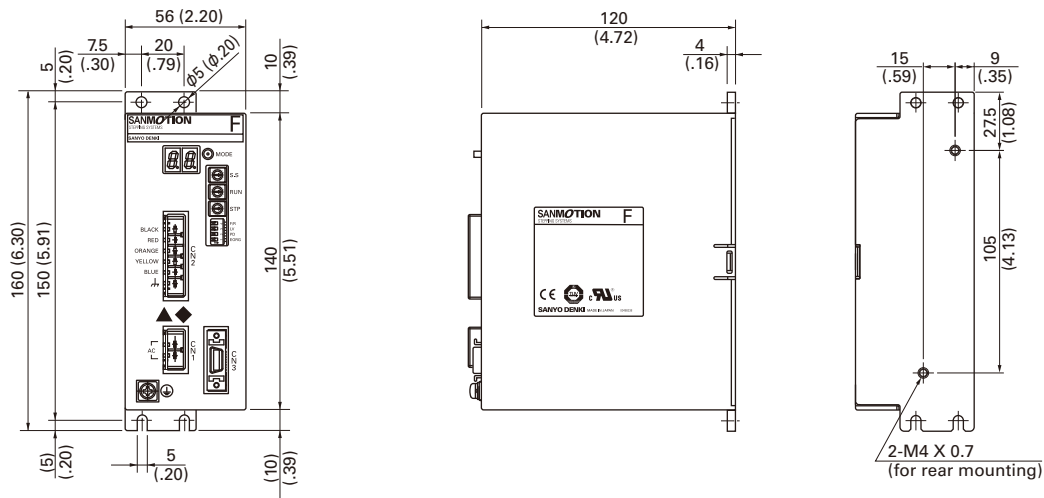

■ Set model configuration driver (DC input microstep)

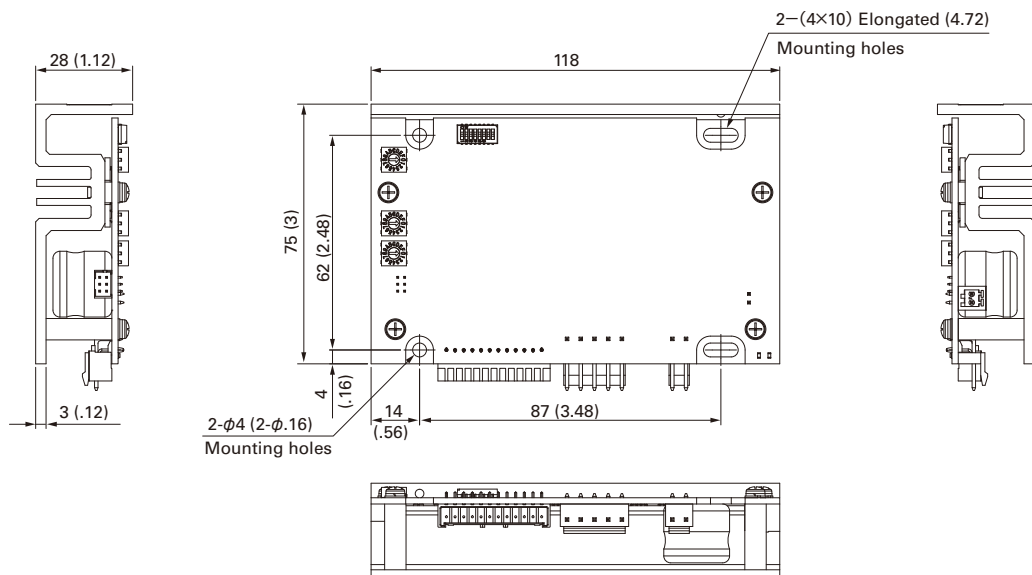

■ Set model configuration driver (DC input full / half step)

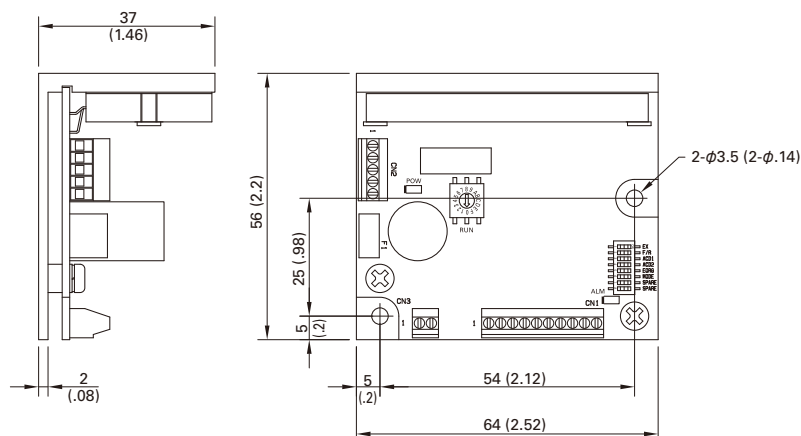

AC input Set model
Micro step

DC input Set model
Micro step

DC input Set model
Full / half step

Stepping Motor

Linear Actuator
Stepping Motor

Stepping motor for
vacuum environment

Dimensions

Linear Actuator Stepping Motor dimensions [Unit : mm (inch)]

Dimensions for models with electromagnetic brake.

42mm sq. (1.65inch sq.)

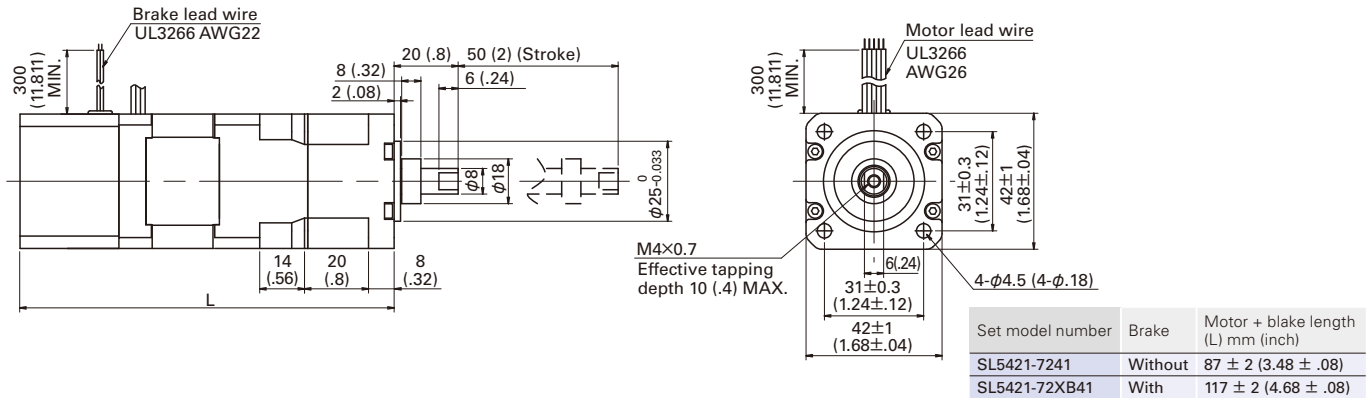

60mm sq. (2.36inch sq.)

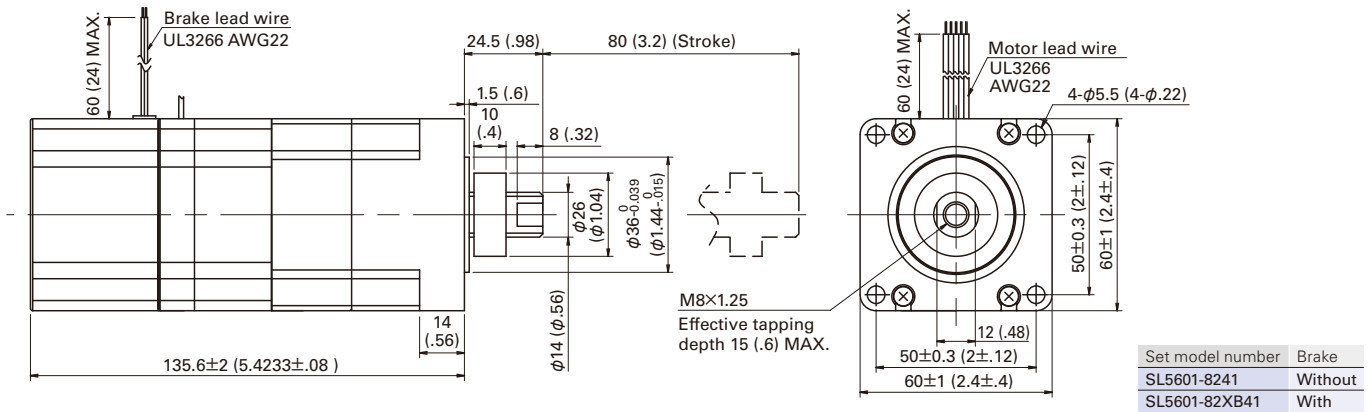

Safety Consideration

The drivers and stepping motors are the products designed to be used for the general industrial devices. When using those, pay enough attention to the following points.

- Read the instructions carefully before installation and assembly, to ensure correct usage. Manuals can be downloaded from our website.
- Refrain from modifying or processing the product in any way.
- Consult with the distributor or professional experts for placement or maintenance services of the product.
- In case of the following uses of the product, contact with us for the special care required to the operation, maintenance and management such as multiplexing the system, installing an emergency electric generator set, or so forth.
 - ① Use for the medical devices concerned with a fatal accident.
 - ② Use for trains, elevators, and so forth that are likely to cause an accident resulting in injury, damage or death.
 - ③ Use in the computer system highly influential to the social life or the public systems.
 - ④ Use in other devices highly influential to maintaining the human safety or the public functions.

In addition to the above, consult with us for use in such a vibration environment as automobile or transportation. Make yourself knowledgeable and familiarize with the devices, safety issues and cautions before handling the product.

Indication by (Warning Label) on the product

Either or all of the following indications are given by the Warning Labels depending on the type of the driver or stepping motor.



This label is stuck near the high voltage part such as the electrically charged or cover-protected section, warning that the place where it is likely to cause an electric shock.



This label is stuck near the GND terminals of the driver or stepping motor for which grounding is required, suggesting that the terminals should be actually grounded.



This label is stuck for the driver or stepping motor to which the power source is applied in the voltage exceeding the safety standard, drawing attention against the electric shock.

Safety ranks of the cautions

Following four ranks are provided.



DANGER Improper operations or use is most likely to result in serious injury or death.



CAUTION Improper operations or use is likely to result in average or minor injury, or in property damage.

In spite of the cautions with the  CAUTION label, it may cause serious results. Either the contents of the labels is describing important cautions to be followed inevitably.



PROHIBITED Indicates what shall not be done.



COMPULSORY Indicates what shall be done.

DANGER

<General matters>

1. Do not use the product in an explosive, flammable or corrosive atmosphere, watery place or near a combustible material. Doing so may cause injury or fire.
2. Have a person with expert knowledge for performing the transportation ,placement,wiring, operation, maintenance or inspection of the product. Without such knowledge, it may cause an electric shock, injury or fire.
3. Do not work for wiring, maintenance servicing or inspection with the electric power on. Perform either of those five minutes after turning the power off, or otherwise, it may cause an electric shock.
4. When the protective functions of the product is activated, turn the power off immediately and eliminate the cause. If continuing the operation without eliminating the cause, the product may operate improperly and cause injury or a breakdown of the system devices.
5. Stepping motor may run out of order at the operating and stopping occasions, depending on the magnitude of the load. Put the product into use after confirming with the adequate trial test operation in the maximum load conditions that the product performs reliable operation. Doing otherwise may cause a breakdown of the system. (Should the product run out of order in the use to drive upward/downward, it may cause a fall of the load.)
6. Do not touch the internal parts of the driver. Doing so may cause an electric shock.

<Wiring>

7. Do not connect the stepping motor directly with the commercial power outlet. Doing so may cause an electric shock, injury or fire. The power shall be supplied to the stepping motor through the driving circuit.
8. Use the electric power source within the rated input voltage. Using otherwise may cause fire or an electric shock.
9. Connect the driver and stepping motor to the ground. Using without grounding may cause an electric shock.
10. Do not harm, forcibly put a stress, or load a heavy article on the cable or get it caught between the articles. Doing so may cause an electric shock.
11. Perform wiring with the power cable as instructed by the wiring diagram or the Operation Manual. Doing otherwise may cause an electric shock or fire.

<Operation>

12. Be sure not to touch the rotating part of the stepping motor during its operation. Touching it may cause injury.
13. Neither reach or touch the electric terminals while electric power is on. Doing so may cause an electric shock.
14. Never disconnect any of the connectors while electric power is on. Doing so may cause an electric shock and corruption.

CAUTION

<General matters>

1. Prior to placement, operation, maintenance servicing or inspection, be sure to read the Operation Manual and follow the instructions to perform those. Failure to follow the instructions may cause an electric shock, injury or fire.
2. Do not use the driver or the stepping motor outside the specified conditions. Doing so may cause an electric shock, injury or fire.
3. Do not insert a finger or a thing into the opening of the product. Doing so may cause an electric shock, injury or fire.
4. Do not use the damaged driver or stepping motor. Doing so may cause injury, fire or the like.
5. Use the driver and stepping motor in the designated combination. Using otherwise may cause fire or a trouble.
6. Be careful that the temperature rises in the operating driver, stepping motor or peripheral devices. Failure to be careful may cause a burn.

<Unpacking>

7. Unpack while confirming the ceiling. Failure to do so may cause injury.
8. Confirm if the product is the one having been ordered. Installing an incorrect product may cause a breakdown.

<Wiring>

9. Do not perform measurement of the insulation resistance or withstand insulation voltage of the product. Doing so may cause a breakdown. Instead, contact with us for such inspection.
10. Perform wiring conforming to the technical standards of electric facility or the internal rule. Doing otherwise may cause burning or fire.
11. Ensure that wiring has been correctly done. Operating without correct wiring may cause the stepping motor to run out of control and result in injury.
12. Take insulation process for the attached condenser or the external resistance connection terminals. Failure to do so may cause an electric shock.

<Placement>

13. Do not climb or attach a heavy article on the product. Doing so may cause injury.
14. Neither block nor stuff the aspiration/exhaust vent with a foreign particle. Doing so may cause fire.
15. Follow the instructions for the direction to place. Failure to do so may cause a trouble.
16. Keep a distance as instructed by the Operation Manual for the driver from the inner surface of the control console or other devices. Failure to do so may cause a trouble.
17. Place the product with a great care so as to prevent from the danger such as a tumble or a turnover.

18. Mount the product on an incombustible material such as metal. Doing otherwise may cause fire.
19. Confirm the rotating direction before connecting with the mechanical device. Failure to do so may cause injury or a breakdown.
20. Do not touch the motor output spindle (including the key slot and gears) with a bare hand. Doing so may cause injury.

<Operation>

21. The stepping motor is not equipped with any protective device. Take protective measures using an over-current protective relay, a ground fault interrupter, a protective device from excess temperature, and an emergency stopping device. Failure to do so may cause injury or fire.
22. Do not touch the product for a period after the power is on or has been turned off, since the driver and stepping motor remain in the high temperature. Doing so may cause burns. Especially the temperature rises considerably of the stepping motor depending on the operating conditions. Use the motor on the condition so that its surface temperature becomes 100° C or under
23. Stop the operation immediately when an emergency occurs. Failure to do so may cause an electric shock, injury or fire.
24. Do not change adjustment to an extreme, for such a change results in the unstable operation. Doing so may cause injury.
25. When conducting the trial operation, make the stepping motor fixed firmly, and confirm the operation by disconnecting with the mechanical system before connecting with it. Failure to do so may cause injury.
26. When the alarm has been activated, eliminate the cause and ensure the safety to resume operation. Failure to do so may cause injury.
27. When the electric power recovers after the momentary interruption, do not approach the devices because the system may re-start operation by itself. (Set the system so as to secure the safety even when it re-start on such occasion.) Failure to do so may cause injury.
28. Confirm that the electric power supply is all proper conforming to the specifications. Failure to do so may cause a trouble.
29. The brake mechanism of the motor with the electro-magnetic brake is to hold the movable section and the motor position. Do not use it as a safety measure, or doing so may cause the breakdown of the system.
30. Fix the key firmly when operating the motor with key individually. Failure to do so may cause injury.

<Maintenance services>

31. Be careful when performing maintenance services or inspection about the temperature which rises highly in the driver and stepping motor frame. Failure to do so may cause burns.
32. It is recommended to replace the electrolytic condenser of the driver with a new one for securing the preventive measure after using for 5 years, the expected life in the average 40° C. The expected life of the fuse and cooling fan motor is 10 years in the average 40° C. Thus, the periodical replacement is recommended.
33. Contact with us for repair. If the product is disassembled by the user, it may put it out of action.

<Transportation>

34. Handle the product with care during transportation so as to prevent from the danger such as a tumble or a turnover.
35. Do not hold with the cable or the motor spindle. Doing so may cause a trouble or injury.

<Retirement>

36. When scrapping the driver or stepping motor, treat it for the general industrial waste.

PROHIBITED

<Storage>

1. Avoid the place exposed to rain or water drops, or in an environment with hazardous gas or liquid for storing the product. Failure to do so may cause a trouble.

<Maintenance services>

2. Do not assemble or repair the product. Doing so may cause fire or an electric shock.

<General matters>

3. Do not remove the rating plate.

COMPULSORY

<Storage>

1. Store the product within the specified conservation temperature and humidity in the place not exposed to the sun beam.
2. If the driver has been stored for a long period (3 years or longer for a guide), consult with us. The capacitance may have decreased with the electrolytic condenser due to the long period storage, and it may cause a trouble.

<Operation>

3. Install an external emergency stop circuit to turn the power off for the instant halt of operation.
4. Put the product into operation in the specified ambient temperature and humidity.

<Transportation>

5. Excess loading of the product on the carrier may cause the load to fall in pieces. Follow the instructions given outside the package.

Inquiry Check Sheet

For more information regarding any products or services described here in, please contact your nearest office listed on the back of this catalog.

To SANYO DENKI Co.,LTD.

Date : _____

Company: _____

Department: _____

Name: _____

Tel: _____

FAX: _____

E-mail: _____

Item	Contents	
①	Name of target equipment	Equipment name, category (transport, processing, test, other)
②	Name of servo axis	Axis name, axial mechanism (horizontal/vertical), brake mechanism (yes/no)
③	Current condition of above axis	Manufacturer Name () Series Name () Motor Capacity () Hydraulic, Mechanical, or New System ()
④	Positioning accuracy	± mm ± μm
⑤	Operation pattern	<p>Acceleration α: ____ G ____ [m/s²] Feeding Speed V: ____ [m/s] Moving Distance D: ____ [m] (Stroke)</p> <p>Time [sec]</p> <p>← t1 () → ← t2 () → ← t3 () →</p> <p>[Reference formula] [1G=9.8[m/s²], 1[m/s²]=0.1G] [α[m/s²]=V[m/sec]÷t1[sec]] [D[m]=V[m/sec]×(t1+t2)[sec]]</p>
⑥	Mechanism	Ball-screw/screw-rotation type (horizontal/vertical), ball-screw/nut-rotation type (horizontal/vertical), rack and pinion (horizontal/vertical), belt/chain (horizontal/vertical), rotary table, roll feed, other
⑦	Mechanical structure	WT(table mass) kg WL(work mass) kg WA(mass of other drive parts) kg WR(rack mass) kg WB(belt/chain mass) kg WC(counterbalance mass) kg Fa(external force axial direction) N Fb(ball-screw preload) N T(roll pushing force) N Dr1(drive-side roll diameter) mm Dr2(follower-side roll diameter) mm
		Lr1(drive-side roll length) mm Lr2(follower-side roll length) mm G(reduction ratio) JG(speed-reducer inertia) kg·m ² JC(coupling inertia) kg·m ² JN(nut inertia) kg·m ² JO(other motor-axis conversion inertia) kg·m ² Db(ball-screw diameter) mm Lb(ball-screw axial length) mm Pb(ball-screw lead) mm
		Dp(pinion/pulley diameter) mm Lp(pinion axial length) mm tp(pully thickness) mm Dt(table diameter) mm Dh(table-support diameter) mm LW(load shift from axis) mm Ds(table shaft diameter) mm Ls(table shaft length) mm
		ρ(specific gravity of ball-screw/pinion/pulley/table-shaft material) kg·cm ³
		μ(friction coefficient between sheet and shilding-surface/support-section/roll) ρ1(specific gravity of roll-1 material) kg/cm ³ ρ2(specific gravity of roll-2 material) kg/cm ³ κ(internal friction coefficient of preload nut)
		η(mechanical efficiency) JL(load inertia of motor-axis conversion) kg·m ² TF(friction torque of motor axis conversion) N·m Tu(imbalance torque of motor axis conversion) N·m
⑧	Speed reducer	Customer-provided (/) Sanyo denki standard(planet/spur/no-backlash-planet /) other(/)
⑨	Encoder type	Encoder type specified (yes / no) Yes:(Wiring saving incremental encoder, battery backup absolute encoder, absolute encoder for incremental system, battery-less absolute encoder) Resolution()
⑩	Input format	Position , velocity , torque , other ()
⑪	Host equipment (controller)	Sequencer , laptop , customer-developed product , Sanyo denki-provided , other ()
⑫	Usage environment and other requirements	Cutting , clean-room use , anti-dust measures , other ()
⑬	Estimated production	Single product: () units/month () units/year
⑭	Development schedule	Prototype period: () Year () Month Production period: () Year () Month
⑮	Various measures	Related documentation (already submitted; send later by mail) Visit/PR desired (yes / no) Meeting desired (yes / no)
⑯	Miscellaneous (questions, pending problems, unresolved issues, etc.)	

■ Precautions For Adoption

Failure to follow the precautions on the right may cause moderate injury and property damage, or in some circumstances, could lead to a serious accident.

Always follow all listed precautions.

Cautions

- Read the accompanying Instruction Manual carefully prior to using the product.
- If applying to medical devices and other equipment affecting people's lives, please contact us beforehand and take appropriate safety measures.
- If applying to equipment that can have significant effects on society and the general public, please contact us beforehand.
- Do not use this product in an environment where vibration is present, such as in a moving vehicle or shipping vessel.
- Do not perform any retrofitting, re-engineering, or modification to this equipment.
- The products presented in this catalog are meant to be used for general industrial applications. If using for special applications related to aviation and space, nuclear power, electric power, submarine repeaters, etc., please contact us beforehand.

*For any question or inquiry regarding the above, contact our Sales Department.

SANYO DENKI CO., LTD.

1-15-1, Kita-Otsuka, Toshima-ku, Tokyo 170-8451, Japan

<http://www.sanyodenki.com>

Phone: +81 3 3917 5157

SANYO DENKI AMERICA, INC.

468 Amapola Avenue Torrance, CA 90501 U.S.A.

Phone: +1 310 783 5400

SANYO DENKI EUROPE SA.

P.A. Paris Nord II, 48 Allée des Erables-VILLEPINTE, BP57286, F-95958 ROISSY CDG Cedex, France

Phone: +33 1 48 63 26 61

SANYO DENKI GERMANY GmbH

Frankfurter Strasse 92, 65760 Eschborn, Germany

Phone: +49 6196 76113 0

SANYO DENKI KOREA CO., LTD.

9F 5-2, Sunwha-dong Jung-gu Seoul, 100-130, Korea

Phone: +82 2 773 5623

SANYO DENKI SHANGHAI CO., LTD.

Rm2107-2109, Bldg A, Far East International Plaza, No.319, Xianxia Rd., Shanghai, 200051, China

Phone: +86 21 6235 1107

SANYO DENKI TAIWAN CO., LTD.

Room 1208, 12F, No.96 Chung Shan N, Rd., Sec.2, Taipei 104, Taiwan, R.O.C.

Phone: +886 2 2511 3938

SANYO DENKI (H.K.) CO., LIMITED

Room 2305, 23/F, South Tower, Concordia Plaza, 1 Science Museum Rd., TST East, Kowloon, Hong Kong

Phone: +852 2312 6250

SANYO DENKI SINGAPORE PTE. LTD.

10, Hoe Chiang Road, #14-03A/04, Keppel Towers, Singapore 089315

Phone: +65 6223 1071

The names of companies and/or their products specified in this catalog are the trade names, and/or trademarks and/or registered trademarks of such respective companies.

*Remarks : Specifications Are Subject To Change Without Notice.

CATALOG No. S0834B010 '13.7IT